



SolaX Power Network Technology (Zhejiang) Co., Ltd.

Add.: No. 278, Shizhu Road, Chengnan Sub-district, Tonglu County,
Hangzhou, Zhejiang, China
E-mail: info@solaxpower.com

Copyright © SolaX Power Network Technology (Zhejiang) Co., Ltd. All rights reserved.



320101040514

X3-MIC G2

3 kW / 4 kW / 5 kW / 6 kW
8 kW / 10 kW / 12 kW / 15 kW

User Manual

Version 14.0

www.solaxpower.com



eManual in the QR code of at
<http://kb.solaxpower.com/>

Change History

Changes between document versions are cumulative. The latest version contains all updates made in previous versions.

Version 14 (Jun. 27, 2024)

- Updated 2.3 Explanation of Symbols (Modified the BIS Logo)
- Updated 5.3 Installation Precaution (Modified the contents)

Version 13 (Mar. 18, 2024)

- Updated 5 Installation and 6 Electrical Connections (Updated contents related to PV connection)

Version 12 (Jan. 12, 2024)

- Updated 2.3 Explanation of Symbols (Deleted the UKCA Logo)
- Updated 5 Installation and 6 Electrical Connections (Updated contents related to AC connection)

Version 11 (Oct. 30, 2023)

- Updated 2.3 Explanation of Symbols (Added the BIS Logo)
- Updated 4.4 General Data (Updated the data)
- Updated 5 Installation and 6 Electrical Connections (Updated contents related to PV terminals)

Version 10 (Jun. 29, 2023)

- Updated 4.2 AC Output (Updated the AC output data)
- Updated 5 Installation and 6 Electrical Connections (Updated the figures and descriptions)
- Updated 7.3 LCD Function & Operation (Added Nline Control)
- Added Appendix: Lockable DC Switch

Version 09 (Dec. 23, 2022)

- Added the model X3-MIC-10KW-G2 and all related contents
- Updated 2.3 Explanation of Symbols (Modified the explanations of the symbols)
- Updated 4 Technical Data (Modified and added new items)
- Updated 6.2 Grid Connection (Modified "Table: Cable and Micro-breaker recommended")

Version 08 (Sep. 8, 2022)

- Updated 2.3 Explanation of Symbols (Modified the TUV mark Logo)
- Updated 2.4 EC Directives (Updated the specific standards)
- Updated 7.3 LCD Function & Operation (Deleted Nline Control)

Version 07 (Jul. 30, 2022)

Modified the layout of the contents and added a new chapter as 6 Electrical Connections (Modified the contents of Communication Connection and added descriptions of parallel connection and EV-Charger function)
 Updated 7.3 LCD Function & Operation (Added setting descriptions related to parallel connection and EV-Charger function)

Version 06 (May 16, 2022)

Added the -LV models which work in low voltage and all related contents

Version 05 (Mar. 25, 2022)

Added notes related to an optional model of 10 kW
 Updated 6.3 LCD Function & Operation (Modified the flow diagram of Grid Protection)
 Updated 7.1 Trouble shooting (Added PowerTypeFault)

Version 04 (Jan. 5, 2022)

Updated 4 Technical Data (Modified the value for Max. short circuit current, Nominal AC voltage and Nominal AC output current; Modified the Safety & Protection part)
 Updated 6.3 LCD Function & Operation (Modified the description of Safety and Grid Services)

Version 03 (Dec. 14, 2021)

Updated 2.3 Explanation of Symbols (Added UKCA and UKNI Logo)
 Updated 5.2 Packing List (Updated the pictures and descriptions)
 Updated 6.3 LCD Function & Operation (Modified the pictures and descriptions)
 Updated 7.1 Trouble shooting (Modified the troubleshooting table)
 Added the Warranty Registration Form

Version 02 (Sep. 13, 2021)

Updated 2.3 Explanation of Symbols (Deleted SAA Logo and added TUV mark Logo)

Version 01 (Aug. 11, 2021)

Updated 7.1 Trouble shooting (Modified the Diagnosis and solution part)

Version 00 (Jun. 11, 2021)

Initial release

Contents

1 Notes on this Manual	03
1.1 Scope of Validity	03
1.2 Target Group	03
1.3 Symbols Used	03
2 Safety	04
2.1 Appropriate Usage	04
2.2 Important Safety Instructions	06
2.3 Explanation of Symbols	08
2.4 EC Directives	10
3 Introduction	11
3.1 Basic Features	11
3.2 Terminals of the Inverter	11
3.3 Dimension	12
4 Technical Data	13
4.1 DC Input	13
4.2 AC Output	14
4.3 Efficiency, Safety and Protection	15
4.4 General Data	16
5 Installation	17
5.1 Check for Transport Damage	17
5.2 Packing List	17
5.3 Installation Precaution	19
5.4 Installation Steps	20
6 Electrical Connections	23
6.1 PV Connection	23
6.2 Grid Connection	28
6.3 Earth Connection	32
6.4 Communication Connection	34
6.4.1 Monitoring Connection (Optional)	34

6.4.2 RS485/Meter Connection 35

 6.4.2.1 Meter Connection (Optional) 37

 6.4.2.2 Parallel connection..... 38

 6.4.2.3 EV-Charger Function..... 40

6.4.3 Upgrade 42

6.5 Run the inverter..... 44

7 Operation Method 45

 7.1 Control Panel 45

 7.2 LCD Display 46

 7.3 LCD Function & Operation 47

8 Troubleshooting..... 62

 8.1 Troubleshooting 62

 8.2 Routine Maintenance 65

9 Decommissioning 66

 9.1 Dismantling the Inverter..... 66

 9.2 Packaging 66

 9.3 Storage and Transportation..... 66

 9.4 Waste Disposal 66

10 Disclaimer 67

Appendix: Lockable DC Switch..... 68

* Warranty Registration Form

1 Notes on this Manual

1.1 Scope of Validity

This manual is an integral part of X3-MIC G2 Series. It describes the assembly, installation, commissioning, maintenance and fault of the product. Please read it carefully before operating.

X3-MIC-3K-G2	X3-MIC-4K-G2	X3-MIC-5K-G2
X3-MIC-6K-G2	X3-MIC-8K-G2	X3-MIC-10K-G2
X3-MIC-10KW-G2*	X3-MIC-12K-G2	X3-MIC-15K-G2
X3-MIC-5K-G2-LV	X3-MIC-6K-G2-LV	X3-MIC-8K-G2-LV

Note: “X3” means three-phase. “MIC” is the name of the product series. “3K” means 3 kW. “G2” means second generation. “LV” means the inverter works in 127 V a.c. /220 V a.c. low voltage range. The products of this series have dual MPPT inputs with DC Switch and with LCD screen.

* This model is specially for Belgium.

Keep this manual at where it is accessible all the time.

1.2 Target Group

This manual is for qualified electricians. The tasks described in this manual can only be performed by qualified electricians.

1.3 Symbols Used

The following types of safety instructions and general information appear in this document as described below:



Danger!
“Danger” indicates a hazardous situation which, if not avoided, will result in death or serious injury.



Warning!
“Warning” indicates a hazardous situation which, if not avoided, could result in death or serious injury.



Caution!
“Caution” indicates a hazardous situation which, if not avoided, could result in minor or moderate injury.



Note!
“Note” provides tips that are valuable for the optimal operation of your product.

2 Safety

2.1 Appropriate Usage

The series inverters are PV inverters which can convert the DC current of the PV generator into AC current and feed it into the public grid.

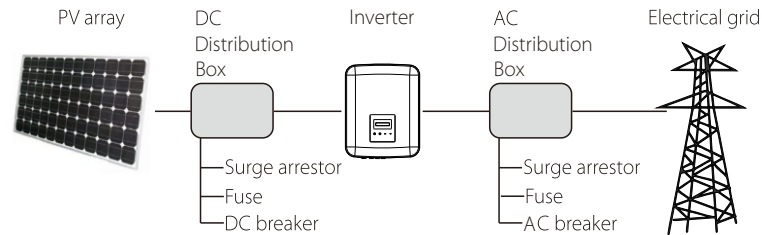

► Surge protection devices (SPDs) for PV installation

Warning!

Over-voltage protection with surge arresters should be provided when the PV power system is installed. The grid connected inverter is fitted with SPDs in both PV input side and MAINS side.

Lightning will cause a damage either from a direct strike or from surges due to a nearby strike.

Induced surges are the more likely cause of lightning damage in the majority of installations, especially in rural areas where electricity is usually provided by long overhead lines. Surges may be induced on both the PV array conductors or the AC cables leading to the building.

Specialists in lightning protection should be consulted in the actual application. Using appropriate external lightning protection, the effect of a direct lightning strike into a building can be mitigated in a controlled way, and the lightning current can be discharged into the ground.

Installation of SPDs to protect the inverter against mechanical damage and excessive stress include a surge arrester in case of a building with external lightning protection system (LPS) when separation distance is kept.

To protect the DC system, surge protection device (SPD type 2) should be fitted at the inverter end of the DC cabling and at the array located between the inverter and the PV generator.

To protect the AC system, surge protection devices (SPD type 2) should be fitted at the main incoming point of AC supply (at the consumer's cutout), located between the inverter and the meter/distribution system; SPD (test impulse D1) for signal line according to EN 61632-1.

All DC cables should be installed to provide as short a run as possible, and positive and negative cables of the string or main DC supply should be bundled together. Avoiding the creation of loops in the system. This requirement for short runs and bundling includes any associated earth bundling conductors.

Spark gap devices are not suitable to be used in DC circuits once conducting, they won't stop conducting until the voltage across their terminals is typically below 30 volts.

► Anti-Islanding Effect

Islanding effect is a special phenomenon that grid-connected PV system still supplies power to the nearby grid when the grid loss happened in the power system. It is dangerous for maintenance personnel and the public. The series inverters provide Active Frequency Drift (AFD) to prevent islanding effect.

2.2 Important Safety Instructions



Danger!

Danger to life due to high voltages in the inverter!

- All work must be carried out by qualified electrician.
- The appliance is not to be used by children or persons with reduced physical sensory or mental capabilities, or lack of experience and knowledge, unless they have been given supervision or instruction.
- Children should be supervised to ensure that they do not play with the appliance.



Caution!

Danger of burn injuries due to hot enclosure parts!

- During operation, the upper lid of the enclosure and the enclosure body may become hot.
- Do not touch the metallic part of the product during operation.



Caution!

Possible damage to health as a result of the effects of radiation!

- Do not stay closer than 20 cm to the inverter for a long time.



Note!

Grounding the PV generator.

- Comply with the local requirements for grounding the PV modules and the PV generator. It is recommended to connect the generator frame and other electrically conductive surfaces in a manner which ensures continuous conduction and ground these in order to have optimal protection of system and persons.



Warning!

- Ensure input DC voltage \leq Max. DC voltage. Over voltage may cause permanent damage to the inverter or other losses, which will not be included in warranty!



Warning!

- Authorized service personnel must disconnect both AC and DC power from the inverter before attempting any maintenance or cleaning or working on any circuits connected to the inverter.



Warning!

Do not operate the inverter when the device is running.



Warning!

Risk of electric shock!

- Prior to the application, please read this section carefully to ensure correct and safe application. Please keep the user manual properly.
- Use only attachments recommended. Otherwise may result in a risk of fire, electric shock, or injury to person.
- Make sure that existing wiring is in good condition and that wire is not undersized.
- Do not disassemble any parts of the inverter which are not mentioned in installation guide. It contains no user-serviceable parts. See Warranty for instructions on obtaining service. Attempting to maintain the inverter by yourself may result in a risk of electric shock or fire and will void your warranty.
- Keep away from flammable, explosive materials to avoid fire disaster.
- The installation place should be away from humid or corrosive substance.
- Authorized service personnel must use insulated tools when installing or working with this equipment.
- PV modules shall have an IEC 61730 class A rating.
- Never touch either the positive or negative pole of PV connecting device. Strictly prohibit touching both of them at the same time.
- The unit contains capacitors that remain charged to a potentially lethal voltage after the MAINS and PV supply has been disconnected.
- Hazardous voltage will present for up to 5 minutes after disconnection from power supply.
- CAUTION - RISK of electric shock from energy stored in capacitor. Never operate on the solar inverter couplers, the MAINS cables, PV cables or the PV generator when power is applied. After switching off the PV and Mains, always wait for 5 minutes to let the intermediate circuit capacitors discharge before you unplug DC and MAINS couplers.
- When accessing the internal circuit of solar inverter, it is very important to wait 5 minutes before operating the power circuit or demounting the electrolyte capacitors inside the device. Do not open the device before hand since the capacitors require time to sufficiently discharge!
- Measure the voltage between terminals UDC+ and UDC- with a multi-meter (impedance at least 1 Mohm) to ensure that the device is discharged before beginning work (35 VDC) inside the device.

PE Connection and Leakage Current

- All inverters incorporate a certified internal Residual Current Device(RCD) in order to protect against possible electrocution and fire hazard in case of a malfunction in the PV array, cables or inverter. There are 2 trip thresholds for the RCD as required for certification (IEC 62109-2:2011). The default value for electrocution protection is 30 mA, and for slow rising current is 300 mA.
- If an external RCD is required by local regulations, it is recommended to choose a Type-A RCD with the rating residual current of 300 mA.

	<p>Warning! High leakage current! Earth connection essential before connecting supply.</p>
---	---

- Incorrect grounding can cause physical injury, death or equipment malfunction and increase electromagnetic.
- Make sure that grounding conductor is adequately sized as required by safety regulations.
- Do not connect the ground terminals of the unit in series in case of a multiple installation. This product can cause current with a d.c. component. Where a residual current operated protective (RCD) or monitoring (RCM) device is used for protection in case of direct or indirect contact, only an RCD or RCM is allowed on the supply side of this product.

For United Kingdom

- The installation that connects the equipment to the supply terminals shall comply with the requirements of BS 7671.
- Electrical installation of PV system shall comply with requirements of BS 7671 and IEC 60364-7-712.
- No protection settings can be altered.
- User shall ensure that equipment is so installed, designed and operated to maintain at all times compliance with the requirements of ESQCR22(1)(a).



For Australia and New Zealand

- Electrical installation and maintenance shall be conducted by licensed electrician and shall comply with Australia National Wiring Rules.











2.3 Explanation of Symbols

This section gives an explanation of all the symbols shown on the inverter and on the type label.

• Symbols on the Inverter

Symbol	Explanation
	Operating status indicator.
	Error indicator.

• Symbols on the Type Label

Symbol	Explanation
	CE mark. The inverter complies with the requirements of the applicable CE guidelines.
	RCM remark.
	TUV certification.
	BIS mark of conformity
	Danger. Risk of electric shock!
	Danger of high voltages. Danger to life due to high voltages in the inverter!
	Beware of hot surface. The inverter can become hot during operation. Avoid contact during operation.
	Danger to life due to high voltage. There is residual voltage in the inverter which needs 5 min to discharge. • Wait 5 min before you open the upper lid or the DC lid.
	Observe enclosed documentation.
	Do not operate this inverter until it is isolated from mains and on-site PV generation suppliers.
	The inverter can not be disposed together with the household waste. Disposal information can be found in the enclosed documentation.

Note: The table is only used for the description of symbols which may be used on the inverter. Please be subject to the actual symbols on the device.

2.4 EC Directives

This section describes the requirements of the European low voltage regulations, including safety instructions and system licensing conditions, the user must comply with these regulations when installing, operating, and maintaining the inverter, otherwise personal injury or death may occur, and the inverter will be damaged. Please read the manual carefully when operating the inverter. If you do not understand "Danger", "Warning", "Caution" and the descriptions in the manual, please contact the manufacturer or service agent before installing and operating the inverter.

Make sure that the whole system complies with the requirements of EC(2014/35/EU, 2014/30/EU, etc.) before starting the module (i.e. to start the operation).

Standard of 2014/35/EU (LVD)
EN IEC 62109-1; EN IEC 62109-2
EN 62477-1

Standard of 2014/30/EU (EMC)
EN IEC 61000-6-1; EN IEC 61000-6-2;
EN IEC 61000-6-3; EN IEC 61000-6-4;
EN IEC 61000-3-2; EN 61000-3-3;
EN IEC 61000-3-11; EN 61000-3-12
EN 55011

The assembly shall be installed in accordance with the statutory wiring rules. Install and configure the system in accordance with safety rules, including the use of specified wiring methods. The installation of the system can only be done by professional assemblers who are familiar with safety requirements and EMC. The assembler shall ensure that the system complies with the relevant national laws.

The individual subassembly of the system shall be interconnected by means of the wiring methods outlined in national/international such as the national electric code (NFPA) No. 70 or VDE regulation 4105.

3 Introduction

3.1 Basic Features

Thanks for your purchasing with the series inverter. The series inverter is one of the finest inverters on the market today, incorporating state-of-the-art technology, high reliability, and convenient control features.

- Advanced DSP control technology.
- Utilize the latest high-efficiency power component.
- Optimal MPPT technology.
 - Two independent MPP Tracking.
 - Wide MPPT input range.
- Advanced anti-islanding solutions.
- IP66 protection level.
- Max. efficiency up to 98.3%. EU efficiency up to 97.8%.
- THDi<3%.
- Safety & Reliability: transformerless design with software and hardware protection.
- Export control.
- Power factor regulation.
- Friendly HMI.
 - LED status indications.
 - LCD display technical data, human-machine interaction through press key.
 - PC remote control.
 - Upgrade through USB interface.
 - WiFi/LAN/4G dongle monitoring.
 - Energy conservation.

3.2 Terminals of the Inverter

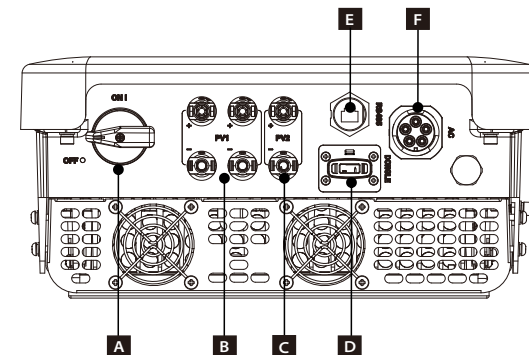

Object	Description
A	DC Switch
B	PV1 Connector
C	PV2 Connector
D	DONGLE
E	RS485
F	AC Connector

**Warning!**

Only authorized personnel is allowed to set the connection.

3.3 Dimension

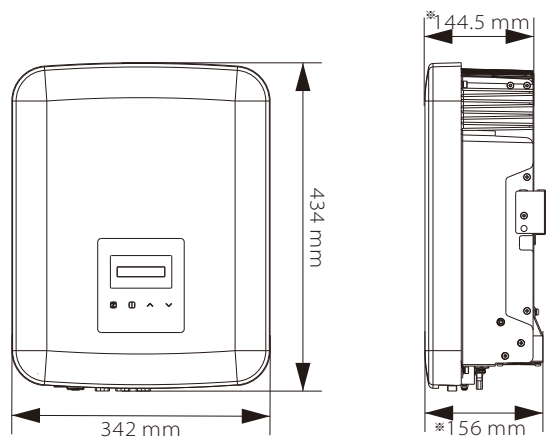

* Size		342 mm*434 mm*144.5 mm	342 mm*434 mm*156 mm
Model	X3-MIC-3K-G2	X3-MIC-8K-G2	X3-MIC-15K-G2
	X3-MIC-4K-G2	X3-MIC-10K-G2	X3-MIC-5K-G2-LV
	X3-MIC-5K-G2	X3-MIC-10KW-G2	X3-MIC-6K-G2-LV
	X3-MIC-6K-G2	X3-MIC-12K-G2	X3-MIC-8K-G2-LV

4 Technical Data

4.1 DC Input

Model	X3-MIC-3K-G2	X3-MIC-4K-G2	X3-MIC-5K-G2	X3-MIC-6K-G2	X3-MIC-8K-G2	X3-MIC-10K-G2
Max. PV array input power [W]	6000	8000	10000	12000	16000	20000
Max. PV voltage [d.c. V]	1000	1000	1000	1000	1000	1000
Rated input voltage [d.c. V]	640	640	640	640	640	640
MPPT voltage range [d.c. V]	120-980	120-980	120-980	120-980	120-980	120-980
MPPT voltage range @ full load [d.c. V]	130-800	170-800	210-800	260-800	315-800	395-800 ^①
Max. PV current [d.c. A]	16/16	16/16	16/16	16/16	16/16	16/16 ^①
Isc PV array short circuit current [d.c. A]	20/20	20/20	20/20	20/20	20/20	20/20 ^①
Startup voltage [d.c. V]	150	150	150	150	150	150
No. of MPPT	2	2	2	2	2	2
Strings per MPPT	1/1	1/1	1/1	1/1	1/1	1/1 ^①
Max. MPPT power limit per MPPT [W]*	3000	4000	5000	6000	8000	8000
DC disconnection switch	Yes					
Max. inverter backfeed current to the array [d.c. A]	0					

Model	X3-MIC-10KW-G2	X3-MIC-12K-G2	X3-MIC-15K-G2	X3-MIC-5K-G2-LV	X3-MIC-6K-G2-LV	X3-MIC-8K-G2-LV
Max. PV array input power [W]	20000	24000	30000	10000	12000	16000
Max. PV voltage [d.c. V]	1000	1000	1000	800	800	800
Rated input voltage [d.c. V]	640	640	640	360	360	360
MPPT voltage range [d.c. V]	120-980	120-980	120-980	120-650	120-650	120-650
MPPT voltage range @ full load [d.c. V]	395-800	315-800	395-800	210-550	260-550	315-550
Max. PV current [d.c. A]	16/16	32/16	32/16	16/16	16/16	16/16
Isc PV array short circuit current [d.c. A]	20/20	40/20	40/20	20/20	20/20	20/20
Startup voltage [d.c. V]	150	150	150	150	150	150
No. of MPPT	2	2	2	2	2	2
Strings per MPPT	1/1	2/1	2/1	1/1	1/1	1/1
Max. MPPT power limit per MPPT [W]*	8000	PV1: 12000 PV2: 8000	PV1: 12000 PV2: 8000	5000	6000	8000
DC disconnection switch	Yes					
Max. inverter backfeed current to the array [d.c. A]	0					

* "Max. MPPT power limit per MPPT" means the maximum PV production when using one of the MPPTs only.

① Input A is optional with two strings (MPPT voltage range@ full load: 300-800 d.c. V, Max. PV current: 32 d.c. A, Isc PV array short circuit current: 40 d.c. A, Strings per MPPT: 2/1).

4.2 AC Output

Model	X3-MIC-3K-G2	X3-MIC-4K-G2	X3-MIC-5K-G2	X3-MIC-6K-G2	X3-MIC-8K-G2	X3-MIC-10K-G2
Rated output apparent power [VA]	3000	4000	5000 ¹	6000	8000	10000 ²
Max. output apparent power [VA]	3300	4400	5500 ¹	6600	8800	11000 ²
Nominal AC voltage [a.c. V]	3~/N/PE, 220/380, 230/400; 3~/PE, 380, 400					
Nominal AC frequency [Hz]	50/60 (±5)					
Rated output current [a.c. A]*	4.6, 4.4	6.1, 5.8	7.6, 7.3	9.1, 8.7	12.2, 11.6	15.2, 14.5
Max. output continuous current [a.c. A]	4.8	6.4	8.0	9.6	12.8	16.0
Current (inrush) [a.c. A]	30 (20 μs)					
THDi, rated power	<3%					
Power factor range	0.8 leading ~ 0.8 lagging					
Feed-in phase	Three-phase					
Maximum output fault current [a.c. A]	44					
Maximum output overcurrent protection [a.c. A]	39					
Short circuit current [a.c. A]	30					

¹ 4999 for AS/NZS 4777.2

² 9999 for AS/NZS 4777.2

Model	X3-MIC-10KW-G2	X3-MIC-12K-G2	X3-MIC-15K-G2	X3-MIC-5K-G2-LV	X3-MIC-6K-G2-LV	X3-MIC-8K-G2-LV
Rated output apparent power [VA]	10000	12000	15000 ³	5000	6000	8000
Max. output apparent power [VA]	10000	13200	15000 ³	5500	6600	8800
Nominal AC voltage [a.c. V]	3~/N/PE, 220/380, 230/400; 3~/PE, 380, 400			3~/N/PE, 127/220; 3~/PE, 220		
Nominal AC frequency [Hz]	50/60 (±5)					
Rated output current [a.c. A]*	15.2, 14.5	18.2, 17.4	22.7, 21.8	13.2	15.8	21
Max. output continuous current [a.c. A]	16.0	19.1	22.7	14.5	17.4	23.1
Current (inrush) [a.c. A]	30 (20 μs)					
THDi, rated power	<3%					
Power factor range	0.8 leading ~ 0.8 lagging					
Feed-in phase	Three-phase					
Maximum output fault current [a.c. A]	44					
Maximum output overcurrent protection [a.c. A]	39					
Short circuit current [a.c. A]	30					

³ 14999 for AS/NZS 4777.2

* If there are two data for this parameter, each data corresponds to the corresponding voltage.

4.3 Efficiency, Safety and Protection

Model	X3-MIC-3K-G2	X3-MIC-4K-G2	X3-MIC-5K-G2	X3-MIC-6K-G2	X3-MIC-8K-G2	X3-MIC-10K-G2
MPPT efficiency	99.90%					
Euro efficiency	97.80%					
Max. efficiency	98.30%					
Safety & Protection						
Over/under voltage protection	YES					
DC isolation protection	YES					
DC injection monitoring	YES					
Back feed current monitoring	YES					
Residual current detection	YES					
Active anti-islanding method	Frequency Shift					
Over temperature protection	YES					
SPD protection	YES					
Arc-fault circuit interrupter(AFCI)	Optional					
AC auxiliary power supply(APS)	Optional					
Safety	IEC/EN 62109-1/-2					
Grid monitoring	EN50549, VDE-AR-N 4105, G98, G99, AS/NZS 4777.2, UTE C15, CEI 0-21, VFR2019					

Model	X3-MIC-10KW-G2	X3-MIC-12K-G2	X3-MIC-15K-G2	X3-MIC-5K-G2-LV	X3-MIC-6K-G2-LV	X3-MIC-8K-G2-LV
MPPT efficiency	99.90%					
Euro efficiency	97.80%					
Max. efficiency	98.30%					
Safety & Protection						
Over/under voltage protection	YES					
DC isolation protection	YES					
DC injection monitoring	YES					
Back feed current monitoring	YES					
Residual current detection	YES					
Active anti-islanding method	Frequency Shift					
Over heat protection	YES					
SPD protection	YES					
Arc-fault circuit interrupter(AFCI)	Optional					
AC auxiliary power supply(APS)	Optional					
Safety	IEC/EN 62109-1/-2 **					
Grid monitoring	EN50549, VDE-AR-N 4105, G98, G99, AS/NZS 4777.2, UTE C15, CEI 0-21, VFR2019 **					

** Please refer to the actual certifications of the specific model.

4.4 General Data

Model	X3-MIC-3K-G2	X3-MIC-4K-G2	X3-MIC-5K-G2	X3-MIC-6K-G2	X3-MIC-8K-G2	X3-MIC-10K-G2
Dimension (W/H/D)[mm]	342*434*144.5				342*434*156	
Dimension of packing (W/H/D)[mm]	433*515*247					
Net weight [kg]	15.5	15.5	15.5	15.5	17.0	17.0 ^①
Installation	Wall-mounted					
Operating ambient temperature range [°C]	-30 to +60					
Storage temperature [°C]	-30 to +60					
Storage/Operation relative humidity	0%~100%					
Altitude [m]	4000					
Ingress protection	IP66					
Isolation type	Transformerless					
Protective class	I					
Night-time consumption [W]	<3					
Overvoltage category	III(MAINS), II(DC)					
Pollution degree	II(Inside), III(Outside)					
Cooling concept	Natural cooling			Smart fan cooling		
Noise level [dB]	<30			<45		
Inverter Topology	Non-isolated					
Communication interface	USB / RS485 / DRM / WiFi/LAN/4G dongle (Optional)					

Model	X3-MIC-10KW-G2	X3-MIC-12K-G2	X3-MIC-15K-G2	X3-MIC-3K-G2-LV	X3-MIC-6K-G2-LV	X3-MIC-8K-G2-LV
Dimension (W/H/D)[mm]	342*434*156					
Dimension of packing (W/H/D)[mm]	433*515*247					
Net weight [kg]	17.0	18.0	18.0	17.0	18.0	18.0
Installation	Wall-mounted					
Operating ambient temperature range [°C]	-30 to +60					
Storage temperature [°C]	-30 to +60					
Storage/Operation relative humidity	0%~100%					
Altitude [m]	4000					
Ingress protection	IP66					
Isolation type	Transformerless					
Protective class	I					
Night-time consumption [W]	<3					
Overvoltage category	III(MAINS), II(DC)					
Pollution degree	II(Inside), III(Outside)					
Cooling concept	Smart fan cooling					
Noise level [dB]	<45	<50	<45	<45	<50	<50
Inverter Topology	Non-isolated					
Communication interface	USB / RS485 / DRM / WiFi/LAN/4G dongle (Optional)					

① Input A is optional with two strings (Net weight: 18.0 kg).

5 Installation

5.1 Check for Transport Damage

Make sure the inverter is intact during transportation. If there are some visible damages, such as cracks, please contact your dealer immediately.

5.2 Packing List

Open the package and fetch out the product, check the accessories at first. The packing list is shown as below.

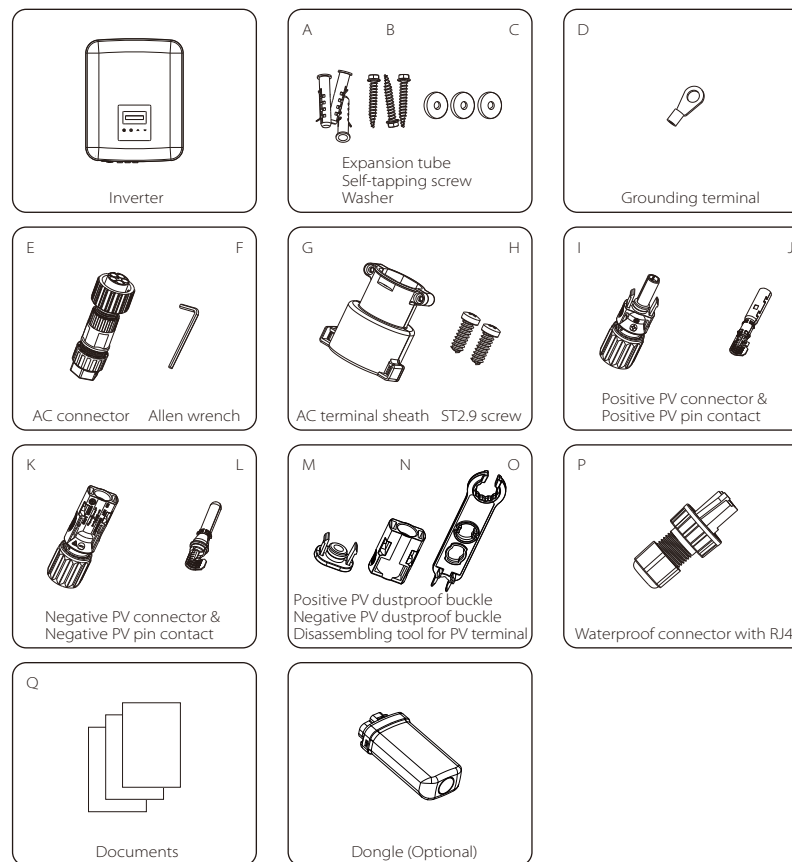

Item	Description	Quantity
/	Inverter	1 pc
A	Expansion tube	3 pcs
B	Self-tapping screw	3 pcs
C	Washer	3 pcs
D	Grounding terminal	1 pc
E	AC connector	1 pc
F	Allen wrench	1 pc
G	AC terminal sheath	1 pc
H	ST2.9 screw	2 pcs
I	Positive PV connector	2 pairs for 3 kW~8 kW and 10 kW (PV1: one string), 3 pairs for 12 kW~15 kW and 10 kW (PV1: two strings)
J	Positive PV pin contact	
K	Negative PV connector	2 pairs for 3 kW~8 kW and 10 kW (PV1: one string), 3 pairs for 12 kW~15 kW and 10 kW (PV1: two strings)
L	Negative PV pin contact	
M	Positive PV dustproof buckle	1 pairs for 3 kW~8 kW and 10 kW (PV1: one string), 2 pairs for 12 kW~15 kW and 10 kW (PV1: two strings)
N	Negative PV dustproof buckle	
O	Disassembling tool for PV terminal	1 pc
P	Waterproof connector with RJ45	1 pc
Q	Documents	/
/	Dongle (Optional)	/

* Refer to the actual delivery for the optional accessories.

5.3 Installation Precaution

The series inverter is designed for outdoor installation (IP66).

- The ambient temperature: -30°C to +60°C.
- The humidity shall be between 0-100%.
- Do not install the inverter in the areas higher than the maximum operating altitude of the inverter.
- Install the inverter in a well-ventilated environment for heat dissipation. It is recommended to install an awning over the inverter if it is installed on a support outdoor.
- Do not install the inverter in areas with flammable, explosive and corrosive materials.
- Do not install the inverter in areas near combustibles and antenna.
- Avoid direct sunlight, rain exposure and snow laying up.
- The slope of the wall should be within $\pm 5^\circ$.
- The wall hanging the inverter should meet conditions as below:
 1. solid brick/concrete, or strength equivalent mounting surface;
 2. Inverter must be supported or strengthened if the wall's strength isn't enough (such as wooden wall, the wall covered by thick layer of decoration).

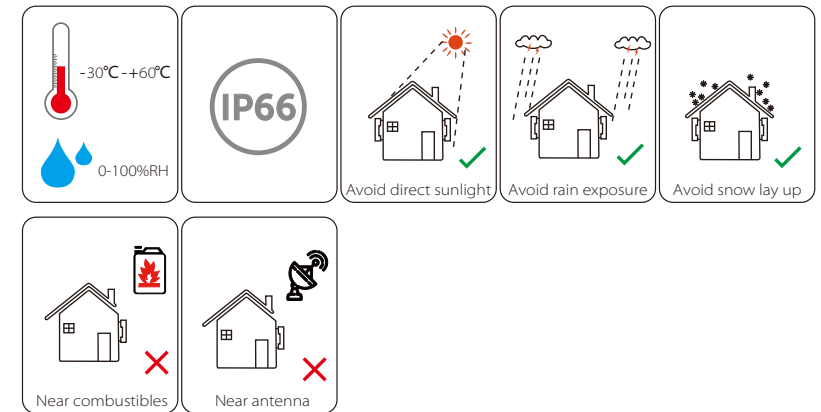

Note!

- For outdoor installation, precautions against direct sunlight, rain exposure and snow accumulation are recommended.
- Exposure to direct sunlight raises the temperature inside the device. This temperature rise poses no safety risks, but may impact the device performance.

5.4 Installation Steps

➤ Preparation

Below tools are needed before installation and electrical connections.



➤ Available Space Size

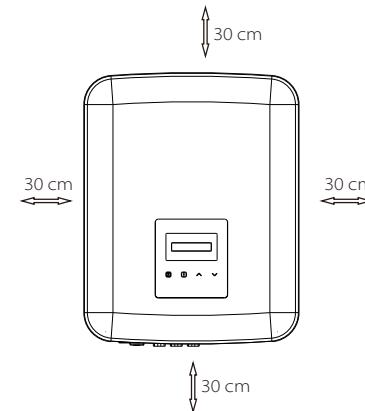



Table: Available Space Size

Position	Min. size
Left	30 cm
Right	30 cm
Top	30 cm
Bottom	30 cm
Front	30 cm

Note!
 Please do not install the inverters in parallel connection before confirming with local installer or us. For more details, please contact us.

➤ Steps

a) Unscrew the bracket from the back of the inverter.

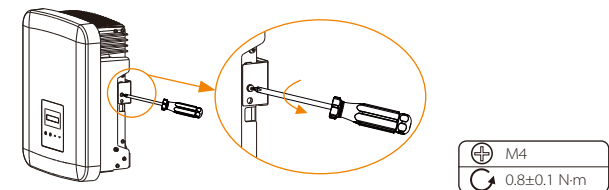

b) Use it as a template to mark the position of the three holes (223 mmx30 mm) on the wall.

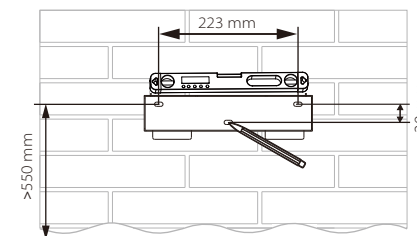

c) Drill holes with Ø10 drill, make sure the holes are deep enough (at least 60 mm) for installation.

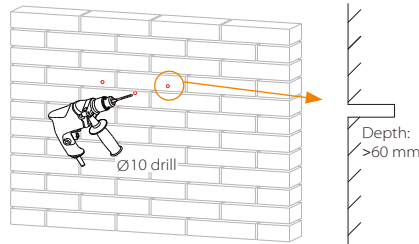

d) Insert the expansion tubes (part A) in the holes.

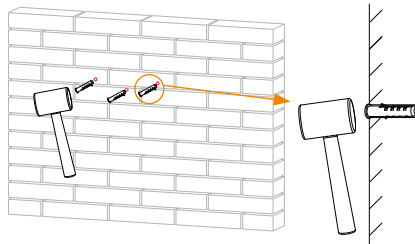

e) Fix the bracket with the self-tapping screws (part B) and washers (part C).

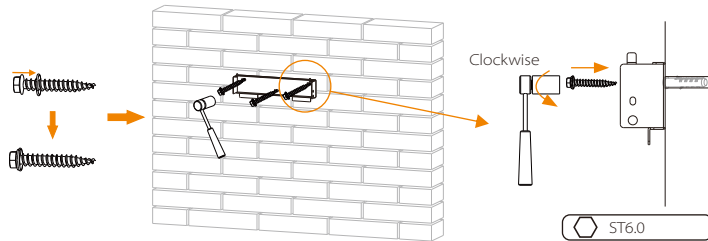

f) Hang the inverter over the bracket, move the inverter close to it, slightly lay down the inverter, and make sure the 2 grooves on the back of the inverter are well-seated on the bracket. And secure it with the cross recessed screw on the right side.

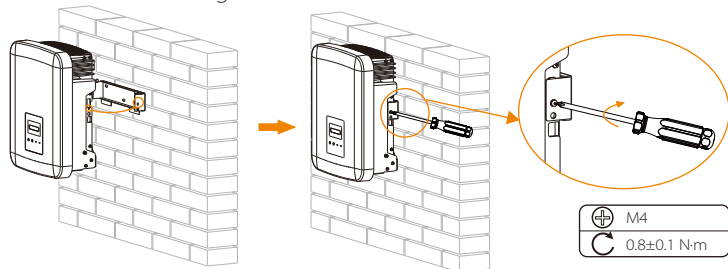

6 Electrical Connections

6.1 PV Connection

The series inverters have a couple of PV connectors which can be connected in series into 2-inputs PV modules. Please select PV modules with excellent function and reliable quality. Open circuit voltage of module array connected should be < Max. DC input voltage (table as below), and operating voltage should be within the MPPT voltage range.

Table: Max. DC Voltage Limitation

Model	X3-MIC-3K-G2	X3-MIC-4K-G2	X3-MIC-5K-G2	X3-MIC-6K-G2	X3-MIC-8K-G2	X3-MIC-10K-G2
Max. DC Voltage	1000 V					

Model	X3-MIC-10KW-G2	X3-MIC-12K-G2	X3-MIC-15K-G2	X3-MIC-5K-G2-LV	X3-MIC-6K-G2-LV	X3-MIC-8K-G2-LV
Max. DC Voltage	1000 V			800 V		

Danger!
 Danger to life due to high voltage on DC conductors. When exposed to sunlight, the PV array generates dangerous DC voltage which is present in the DC conductors. Touching the DC conductors can lead to lethal electric shocks. Do not cover the PV modules.

Warning!
 The voltage of PV modules is very high and dangerous, please comply with the electric safety rules when connecting.

Warning!
 Do not ground the positive or negative pole of the photovoltaic module!

Note!
 Please follow the requirements of PV modules as below: Same type; Same quantity; Identical alignment; Identical tilt. In order to save cable and reduce the DC loss, we suggest installing the inverter near PV modules.

● **Connection Steps**

a) Turn off the DC switch, connect the PV module, prepare a 4 mm² PV cable, and find the PV pin contacts (part J & L) and PV connectors (part I & K) in the package.

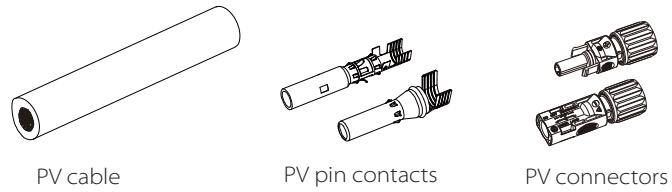

b) Use a wire stripper to strip 7 mm insulation layer from the wire end.

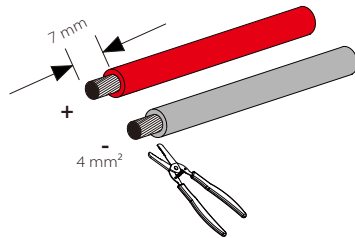

c) Insert the stripped section into positive pin contacts and negative pin contacts (part J & L), make sure all wires are captured in the pin contacts.

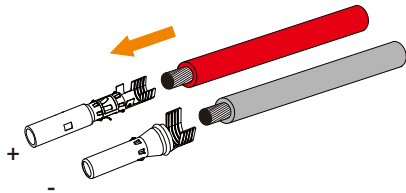

d) Use the crimping tool for PV terminals to crimp the pin contacts so that the stripped section of the PV cable is firmly contacted with the pin contacts.

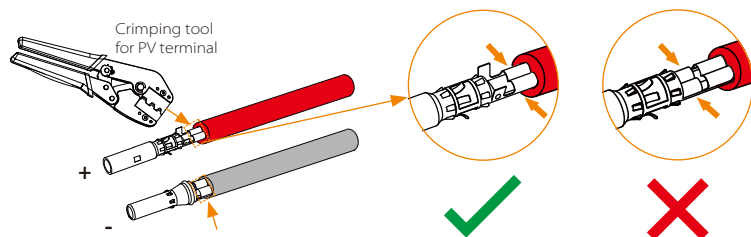

e) Loosen the cable nut from the PV connectors (part I & K). Thread the cable through the cable nuts and the plugs.

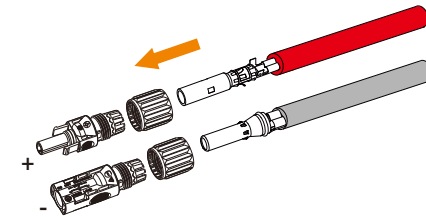

f) Force the cable pair into the plugs. There will be a sound of "Click" if the cable is correctly and completely seated.

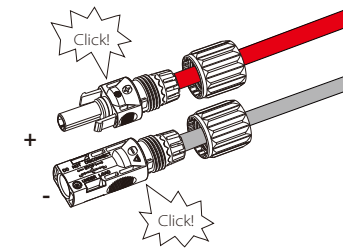

g) Tighten the cable nuts.

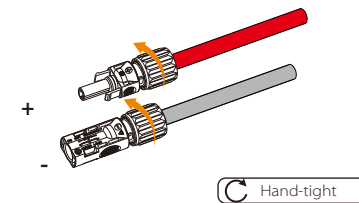

h) Before connecting to the inverter, please turn on the switch of the PV strings and use a multimeter to measure the open circuit voltage of the positive pole and negative pole of the PV cable, and make sure the open circuit voltage \leq the max. DC voltage.

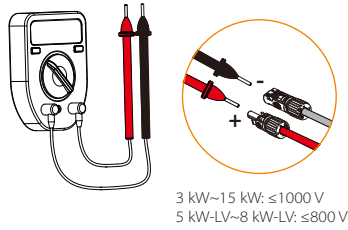

i) Remove the terminal caps from the inverter.

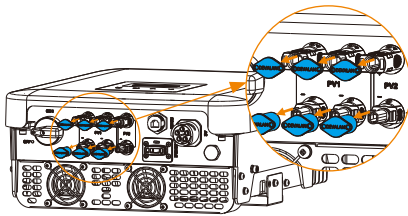

j) Connect to the corresponding port (+ and -) of the inverter until there is an audible click.

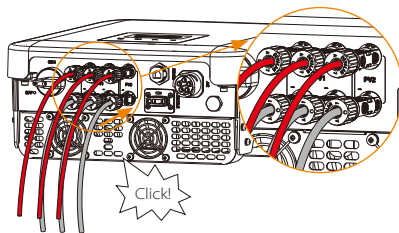

* Seal the unused PV terminals with the dustproof buckles (part M & N) from the accessory.

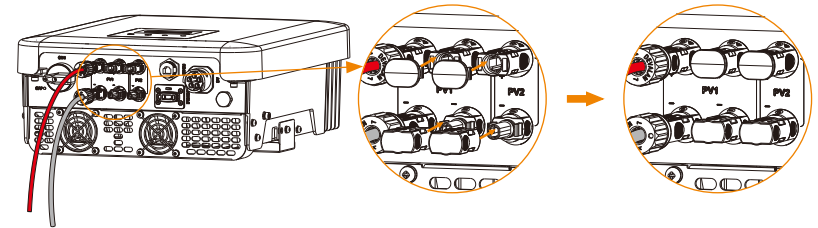

● **Disassembling the dustproof buckles and the PV cables**

Disassemble the dustproof buckles with the disassembling tool for PV terminal (part O).

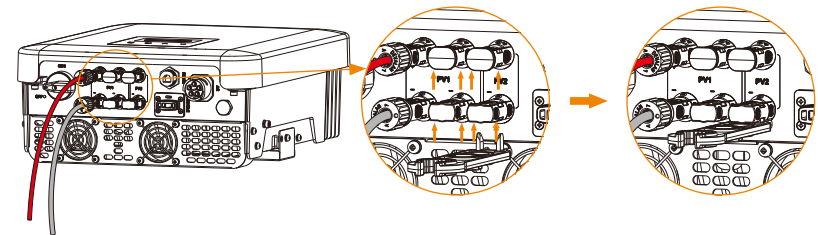

Disassemble the PV connectors with the disassembling tool for PV terminal. Then remove the PV cable and slightly pull out the PV connectors.

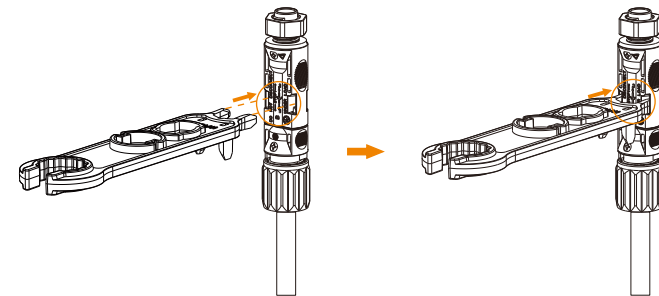

6.2 Grid Connection

The series inverters are designed for three phase grid. For the rated grid voltage and frequency, please refer to the section “Technical Data”. Other technical requests should comply with the requirement of the local public grid.

Table: AC cable and circuit breaker recommended

Model	X3-MIC-3K-G2	X3-MIC-4K-G2	X3-MIC-5K-G2	X3-MIC-6K-G2	X3-MIC-8K-G2	X3-MIC-10K-G2
L1, L2, L3 Cable	4-5 mm ²	4-5 mm ²	4-5 mm ²	5-6 mm ²	5-6 mm ²	5-6 mm ²
PE, N Cable	2.5-5 mm ²	2.5-5 mm ²	2.5-5 mm ²	2.5-6 mm ²	2.5-6 mm ²	2.5-6 mm ²
Circuit breaker	16 A	16 A	16 A	20 A	20 A	20 A

Model	X3-MIC-10KW-G2	X3-MIC-12K-G2	X3-MIC-15K-G2	X3-MIC-5K-G2-LV	X3-MIC-6K-G2-LV	X3-MIC-8K-G2-LV
L1, L2, L3 Cable	5-6 mm ²	5-6 mm ²	5-6 mm ²	5-6 mm ²	5-6 mm ²	5-6 mm ²
PE, N Cable	2.5-6 mm ²	2.5-6 mm ²	2.5-6 mm ²	2.5-6 mm ²	2.5-6 mm ²	2.5-6 mm ²
Circuit breaker	20 A	25 A	32 A	20 A	25 A	32 A

*The parameters have some differences because of different environment and material. Please choose appropriate cable and micro-breaker according to the local conditions.

Micro-breaker should be installed between inverter and grid, any loads should not be connected with inverter directly.

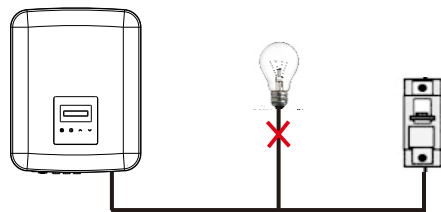

Incorrect Connection between Loads and Inverter

• Connection Steps

Note:

Check the grid voltage and compare with the permissive voltage range (refer to technical data).

Disconnect the circuit-bricker from all the phases and secure against re-connection.

a) Disassemble the AC connector (part E) into three parts: Hold the male insert, anti-clockwise rotate the back shell to loosen it, and detach it from male insert. Then remove the cable nut from the back shell.

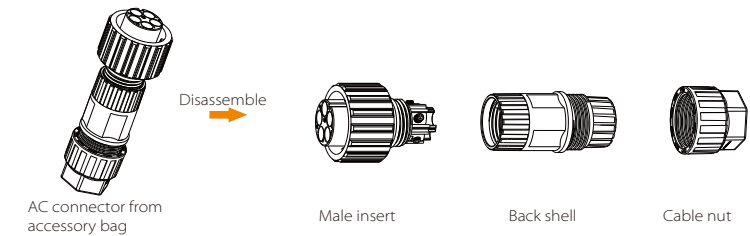

b) Remove the insulation jacket to 52.5 mm for L1, L2, L3 and N wire, 55 mm for PE wire. Strip the insulation of L1, L2, L3, N wire and PE conductor (12 mm). Then slide the cable nut and back shell onto the cable.

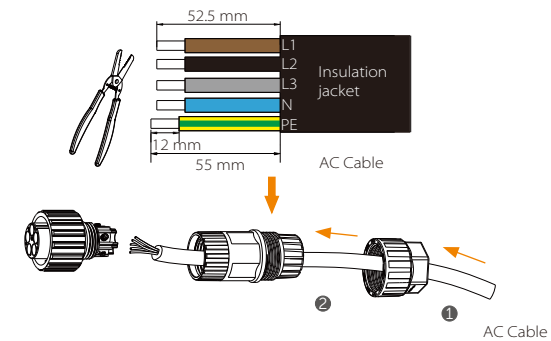

c) Insert the stripped end of the five wires into the appropriate holes of the male insert (The N wire and PE wire must be connected correctly), and then tighten each screw to ensure each wire in place using the accompanying Allen wrench (part F).

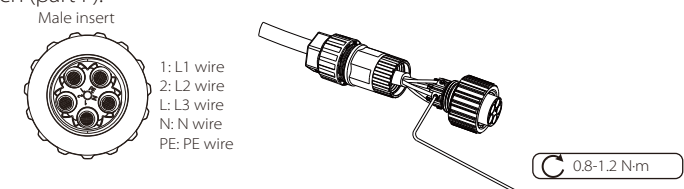

d) Tighten the back shell and the male insert. Then tighten the back shell and the cable nut.

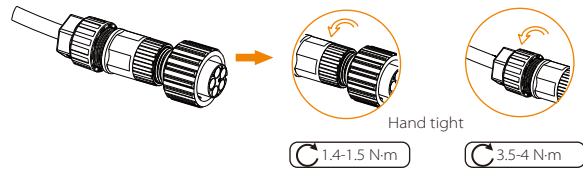

e) Align the groove of male insert on the side of AC connector with the convex of female terminal on the side of the inverter.

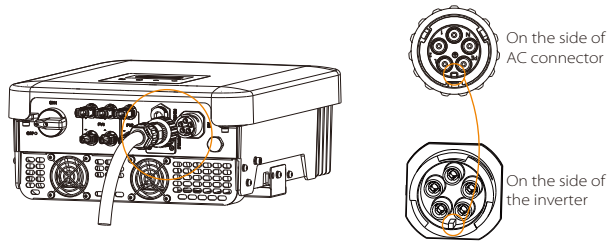

f) Tighten the bush of the male terminal to connect the AC connector with the inverter.

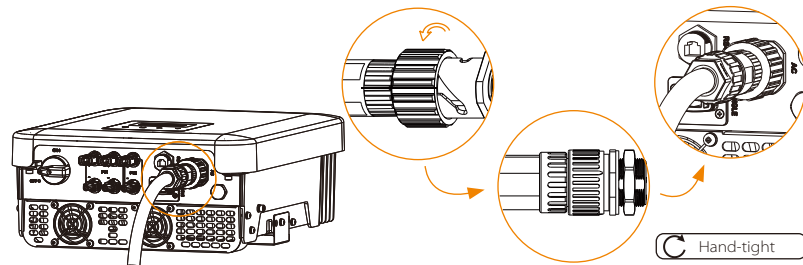

g) Take out the AC terminal sheath (part G), separate it into two parts, and align them with the connected AC connector as shown below. Then, insert the two ST2.9 screws (part H) into the fixing holes and use a screwdriver to tighten them.

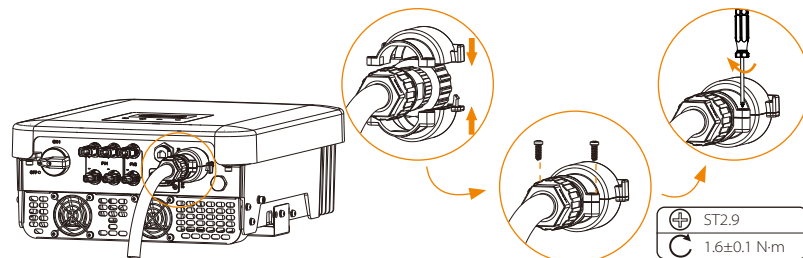

Danger!

The AC terminal sheath must be installed, or there may be a risk of danger.

Selection of Fuses and Cables

Mains cable (AC line cable) shall be short-circuit protected and thermal overload protected.

Always fit the input cable with fuse. Normal gG (US: CC or T) fuses will protect the input cable in short circuit situation. They will also prevent damage to adjoining equipment.

Dimension the fuses according to local safety regulations, appropriate input voltage and the related current of the solar inverter.

AC output protected by external fuse (gG rated current 16 A/600 VAC for X3-MIC-3K-G2/X3-MIC-4K-G2/X3-MIC-5K-G2/X3-MIC-6K-G2; 25 A/600 VAC for X3-MIC-8K-G2/X3-MIC-10K-G2/X3-MIC-10KW-G2/X3-MIC-5K-G2-LV; 40 A/600 VAC for X3-MIC-12K-G2/X3-MIC-15K-G2/X3-MIC-6K-G2-LV/X3-MIC-8K-G2-LV) provides in all live connections to the AC supply.

The rated short-circuit breaking capacity of the above protective device shall be at least equal to the prospective fault current at the point of installation. See section technical data of this manual for details.

AC output cable: Cu; R, S, T, N+PE: 3*4.0 mm²+4.0 mm² for X3-MIC-3K-G2/X3-MIC-4K-G2/X3-MIC-5K-G2 and 3*5.3 mm²+5.3 mm² for X3-MIC-6K-G2/X3-MIC-8K-G2/X3-MIC-10K-G2/X3-MIC-10KW-G2/X3-MIC-5K-G2-LV, 3*6 mm²+6 mm² for X3-MIC-12K-G2/X3-MIC-15K-G2/X3-MIC-6K-G2-LV/X3-MIC-8K-G2-LV @40°C ambient temperature.

Note!



1. For condition differing from those mentioned above, dimension the cables according to local safety regulations, appropriate input voltage and the load current of the unit. (You can choose a thicker cable but the fuses must be rated according to the rating of the cable.)
2. Fuses must be approved by Notified Body.
3. The AC output cable would be better to use the soft wire.

Therefore the current-carrying capacity of the components and sub-assemblies provided in the end-use system(connectors, cables, junction box, switchgear, etc.) and the reverse current PV modules shall be considered based on the feedback current and reverse current. The direct current(DC) circuit breaker or fuse between each solar generator and inverter shall be provided based on solar inverter input ratings.

Select DC cables based on the above inverter back-feed current and ISC PV rating and Vmax ratings.

6.3 Earth Connection

a) Strip the insulation of the conductor by wire stripper.

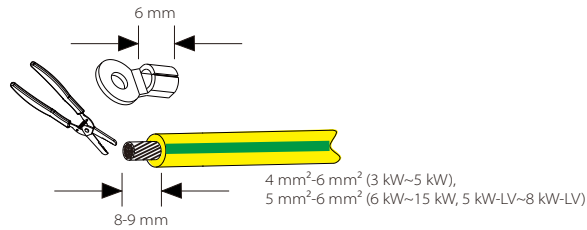

b) Pull the heat shrink tubing over the PE cable and insert the stripped section into the grounding terminal (part D).

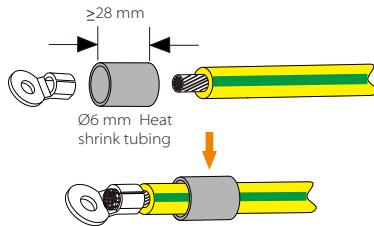

c) Crimp it with crimping tool, pull the heat shrink tubing over the crimped section of the grounding terminal and use a heat gun to shrink it so that it can be firmly contacted with the terminal.

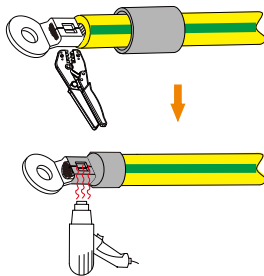

d) Remove the grounding screw from the right side of the inverter.

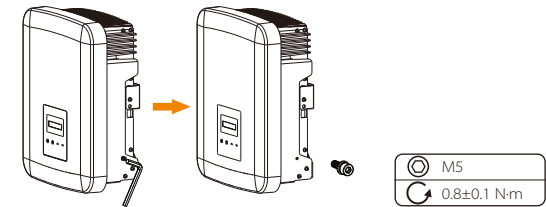

e) Connect the PE cable to the inverter and secure it with Allen wrench.

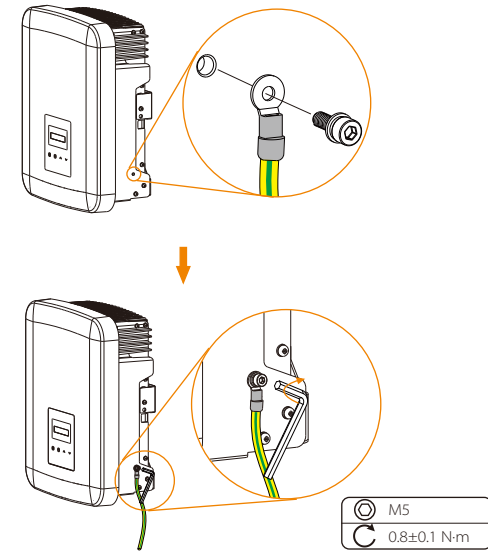

6.4 Communication Connection

This product has a series of communication interfaces: such as WiFi, RS485/Meter, DRM and USB for upgrading for human and machine communication. Operating information like output voltage, current, frequency, faulty information, etc., can be delivered to PC or other monitoring equipment via these interfaces.

6.4.1 Monitoring Connection (Optional)

This inverter provides a monitoring dongle connecting port (the DONGLE port) which can collect information from the inverter including status, performance and updating information to the monitoring website via connecting WiFi/LAN/4G dongle (The monitoring dongle is optional, which can be purchased from the supplier if needed).

Connection steps (Take WiFi dongle as an example):

a) Plug the WiFi dongle into "DONGLE" port at the bottom of the inverter.

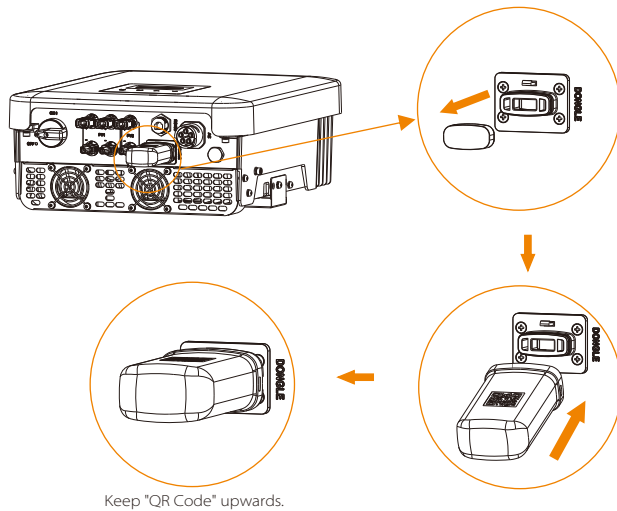

b) Connect the WiFi with router.

c) Download the monitoring APP for setting up.

d) Follow the steps to create a new account, set up internet connections and check the inverter status.

(For more details of the monitoring configuration, please refer to the WiFi /LAN/4G dongle user manual in the box.)

6.4.2 RS485/Meter Connection

There is an RS485 port on the bottom of the inverter. Through this port, the inverter can 1) communicate with the computer, Datahub or other devices and the meter and achieve the parallel function or EV-Charger function; or 2) achieve multiple functions like DRM (Demand Response Management), dry contact function and heat pump control via Adapter Box.

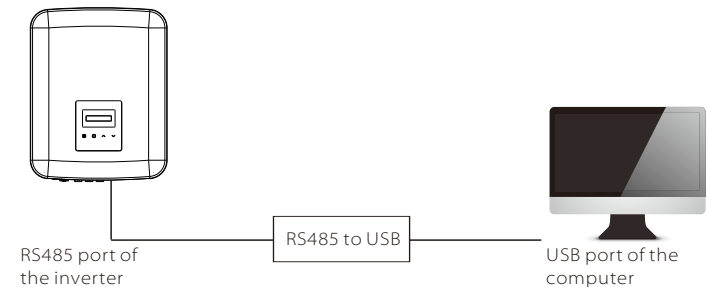

The product is equipped with a Modbus interface via RS485 port. The Modbus interface can be connected via RS485 to USB cable or external Modbus control device to SCADA systems for industrial use and has the following tasks:

- Remote query of measured values,
- Remote setting of operating parameters,
- Setpoint specifications for system control.

• RS485 Connection Steps:

a) Find the waterproof connector with RJ45 (part K) from the accessory bag and disassemble it.

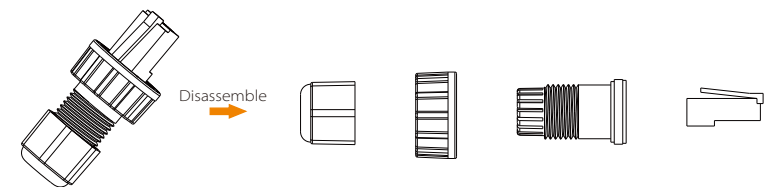

b) Let the communication cable pass through the disassembled parts of the waterproof connector with RJ45. Then strip the insulation jacket from the communication cable.

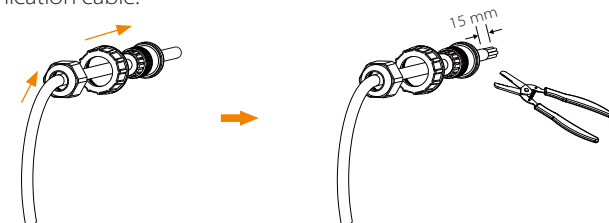

c) Insert the stripped cable into the RJ45 connector following the PIN definition rule and crimp the RJ45 connector with the crimping plier.

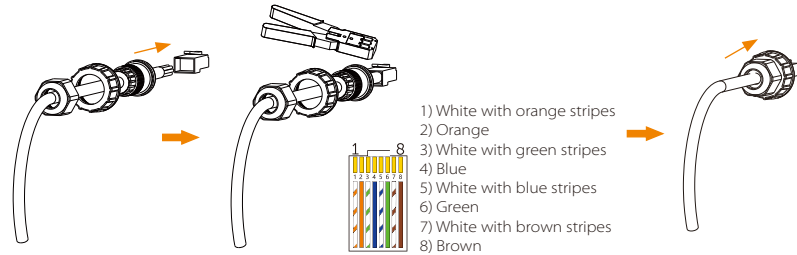

d) Remove the protective cover on the RS485 port.

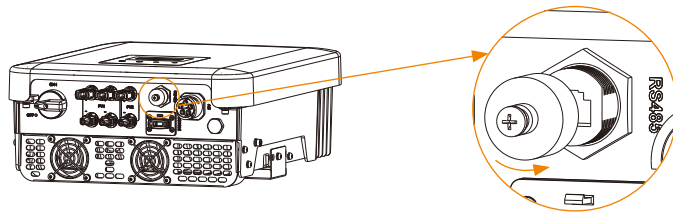

e) Connect the cable to the RS485 port of the inverter.

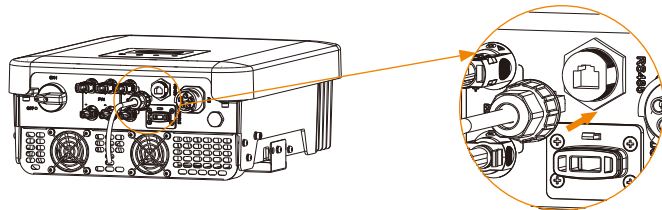

f) Tighten the waterproof connector.

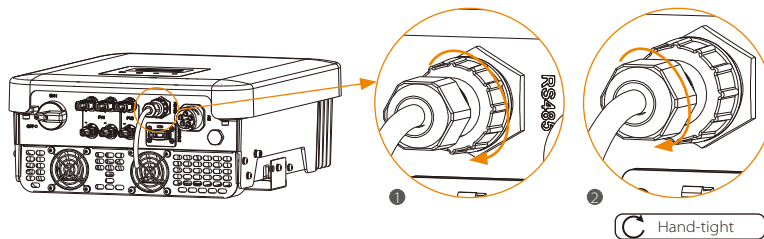

• PIN Definition:

a) The PIN definitions of RS485/Meter interface are as below.

Pin	1	2	3	4	5	6	7	8
Definition	X	X	X	485_A	485_B	X	X	X

b) DRM is provided to support several demand response modes by giving control signals as below.

Pin	1	2	3	4	5	6	7	8
Definition	+12V	DRM0	X	X	X	X	X	X

Note: DRM0 (Demand Response Mode) here is specifically for AS/NZS 4777.2:2020; Short connect PIN1 (+12V) and PIN2 (DRM0) via external switch or relay, the inverter will reduce its output power to zero. This remote shutdown function also applies to other safety codes.

c) Heat Pump Controller is the controlling signal provide by the inverter to switch on or off the SG ready heat pump via Adapter Box. The PIN definition is as below:

Pin	1	2	3	4	5	6	7	8
Definition	X	X	Heat Pump	X	X	GND	X	X

6.4.2.1 Meter Connection (Optional)

The inverter can communicate with a meter through this interface, with the meter you can:

1. Monitor the energy to grid and from grid throughout the whole day.
2. Achieve the export control function with a higher accuracy.

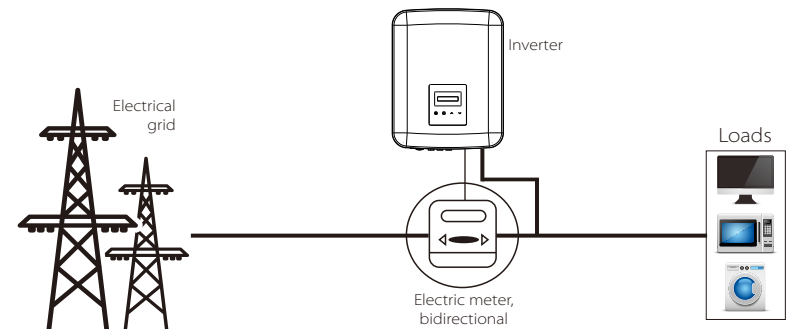

Note!
 The smart meter must be authorized by us, any third party or non-authorized meter may not match with the inverter. We will not take the responsibility if the unauthorized meter is unavailable.

Meter Connection Steps:

Please see the Quick Installation Guide for three-phase meter for details.

6.4.2.2 Parallel connection

The series inverter provides the parallel connection function when connected with Datahub, which could support at most 60 inverters to parallel in one system and can control zero injection to the grid with a meter installed in the main circuit. In this parallel system, the Datahub will be the master of the system, and all the inverters are the slaves. The Datahub can communicate with all the slave inverters.



Note!

The series inverter cannot work in parallel system without Datahub.

Diagram: Parallel system with Datahub

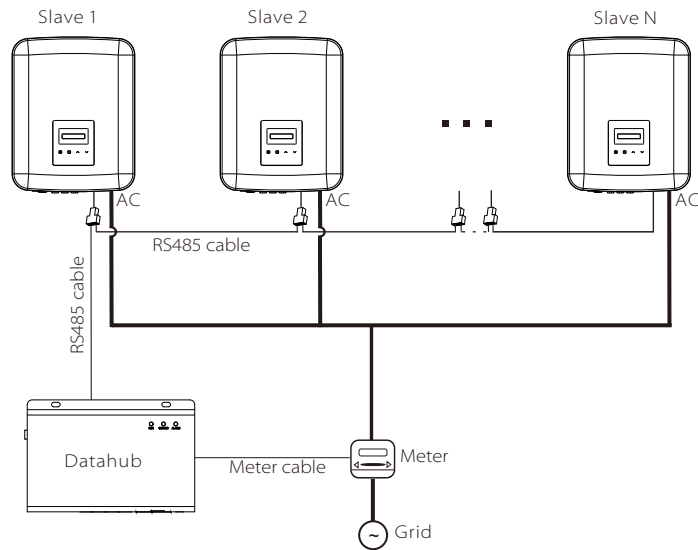

Note!

Before operation, please make sure that the inverters meet the following conditions:

1. All the inverters are recommended to be the same series;
 2. The firmware version of all inverters shall be the same.
- Otherwise, the parallel function cannot be used.



Note!

Before connecting the Datahub to the parallel system, please check that the inverters' settings meet the following conditions:

1. The "Modbus Function" should be "COM485".
2. The "ParallelSetting" should be "Disable".
3. The addresses of all the inverters in the "RS485 CommAddr" should be **different**. Otherwise, please reset the RS485 communication addresses.

• Wiring operation

- a) Prepare several RJ45 splitters as needed.
- b) Connect one end of an RS485 communication cable with Datahub, and the other end with one of the slave inverters via a splitter.
- c) Connect all the slave inverters with each other with RS485 cables via splitters.
- d) Connect the meter with the Datahub and the mains.



Note!

The inverter connected with the Datahub should not enable the "ParallelSetting".

There is no need to set the "ParallelSetting" on the inverters, the parallel system with Datahub will start automatically.

For the details, please refer to the user manual of Datahub.

6.4.2.3 EV-Charger Function

The inverter can communicate with the smart EV-Charger to form an intelligent photovoltaic, storage and EV charging energy system, thus maximizing the utilization of photovoltaic energy.

Diagram: Intelligent Photovoltaic, Storage and EV Charging Energy System

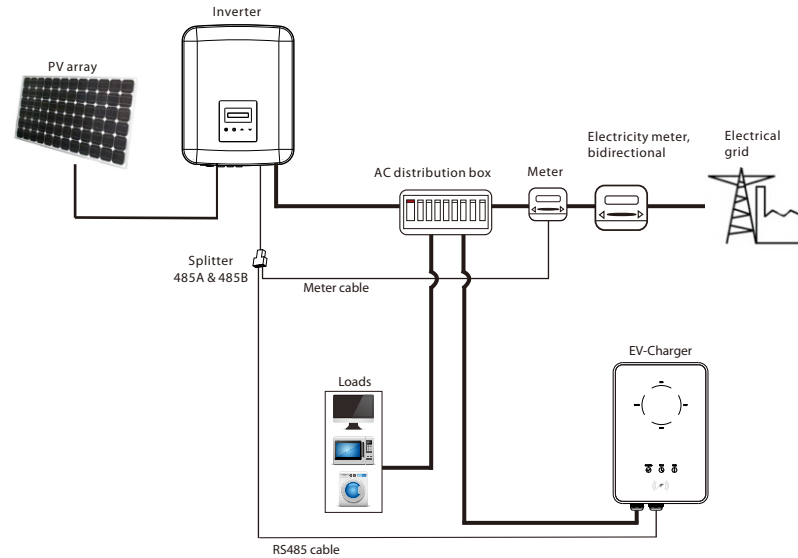

- **Wiring operation**

- Prepare an RJ45 **splitter** and the **splitter** should be placed in a waterproof place.
- Connect the communication cables of the EV-Charger, the meter and the inverter via the splitter following the PIN definition rules.
- The communication cable connected with the inverter should be plugged into the RS485 port of the inverter.

- **LCD setting**

Turn on the power of the entire system, enter the "Settings" page of the inverters on the LCD screen.

- Enter the "Export Control" page and choose "Meter".

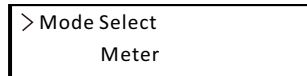
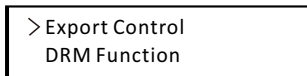

- Enter "Modbus Fuction" and select "EV Charger".

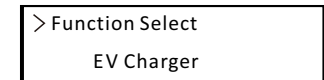
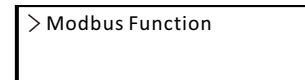

- Set the "Grid Data Source" as "Inverter" in the APP of the EV-Charger.

For the installation and settings of the EV-Charger, please refer to the user manual of the EV-Charger for details.

Note!

The EV-Charger function and the parallel system with Datahub cannot be used at the same time currently. If the EV-Charger function is enabled and Datahub is connected in the system, please remove the Datahub, then the EV-Charger will work normally. If the Datahub is to be remained in the parallel system, remove the Datahub first and change "EV Charger" to "COM485" under the "Modbus Fuction", then reconnect the Datahub.

6.4.3 Upgrade

The inverter system can be updated through an U-disk.



Warning!

Make sure the input voltage is more than 140 V (in good illumination condition), or it may result in failing during updating.

Upgrade Steps:

1) Please contact our service support to get the update file, and extract it into your U-disk as the following file path:

"update\ARM\618.xxxxx.00_XXXXXXXX_ARM_Vx.xx_xxxxxxx.usb";
 "update\DSP\618.xxxxx.00_XXXXXXXX_DSP_Vx.xx_xxxxxxx.usb".

Note: Vx.xx is version number, xxxxxxx is file completion date.



Warning!

Make sure the directory is in accordance with above form strictly! Do not modify the program file name! Or it may cause the inverter to stop working!

2) Make sure the DC switch is off and the AC is disconnected with grid. If the WiFi dongle is connected to the port, please remove the WiFi dongle at first.

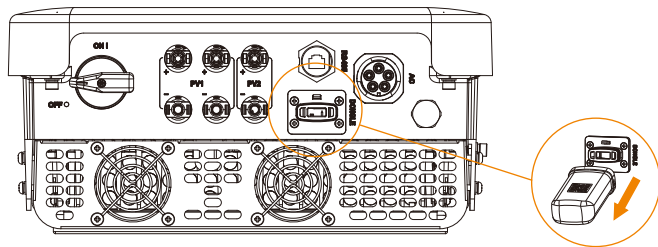

3) Then insert the U-disk into the DONGLE port on the bottom of the inverter. Then turn on DC switch and connect the PV connector, the LCD will show a picture as below.

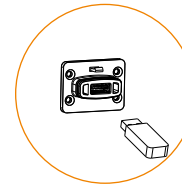

===== Update =====

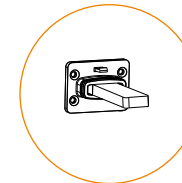

4) Press "Up" and "Down" to select ARM or DSP. Then long press "Down", and select the correct update file to confirm the update. ARM and DSP shall be updated one by one.

5) After the upgrade is completed, please remember to turn off the DC switch or disconnect the PV connector, then pull off the U-disk, and connect the WiFi dongle back.



Warning!

During updating, don't turn off the DC switch or disconnect the PV connector. If the updating stopped due to PV power failure, do not unplug the U-disk. When the PV power supply recovers, the update will continue. If the updating stopped due to other reasons, reinsert the U-disk to continue the update.

6.5 Run the inverter

Start inverter after checking all below steps:

- a) Check that device is fixed well on the wall.
- b) Make sure all the DC breakers and AC breakers are OFF.
- c) AC cable is connected to grid correctly.
- d) All PV panels are connected to inverter correctly, PV connectors which are not used should be sealed by a cap.

Start inverter

- Turn on the DC switch to the "ON" position. (For Lockable DC switch, please refer to the appendix.)
 - Turn on the external AC breaker.
 - Inverter will start automatically when PV panels generate enough energy.
 - Check the status of LED indicators and LCD screen, the LED indicators should be blue and the LCD screen should display the main interface.
- If the LED indicators is not blue, please check the below:
- All the connections are correct.
 - All the external disconnect switches are closed.
 - The DC switch of the inverter is in the "ON" position.

Below is the three different states when operating, which means inverter starting up successfully.

Waiting: Inverter is waiting to check when DC input voltage from panels is greater than 120 V (lowest operating voltage) but less than 150 V (lowest start-up voltage).

Checking: Inverter will check DC input environment automatically when DC input voltage from the PV panels exceeds 150 V and PV panels have enough energy to start inverter.

Normal: Inverter begins to operate normally with blue light on. Meanwhile feedback energy to grid, LCD displays present output power.



Warning!
Power to the unit must be turned on only after installation work has been completed. All electrical connections must be carried out by qualified personnel in accordance with legislation in force in the country concerned.



Note!
Please set the inverter if it is the first time to start up. Above steps are for the regular start of the inverter. If it is the first time to start up the inverter, you need to configure the settings for the inverter after start-up.

7 Operation Method

7.1 Control Panel

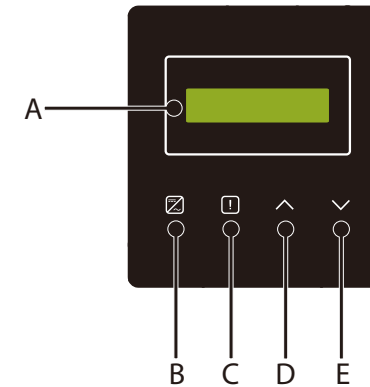

Object	Name	Description
A	LCD Screen	Display the information of the inverter.
B	LED Indicator	Light in blue: The inverter is in normal status.
C		Flash in blue: The inverter is in waiting status.
C		Light in red: The inverter is in fault status.
D	Function Button	Up/Back button: Move cursor to upside or increase value. Return from current interface or function.
E		Down/Enter button: Move cursor to downside or decrease value. Confirm the selection.

Note:

Key	Operation	Description
^ Up/Back	Long Press	Return to the previous menu or confirm function setting
	Short Press	Look at the previous parameter or increase the value
v Down/Enter	Long Press	Go to the next menu or confirm value change
	Short Press	Look at the next parameter or decrease the value

7.2 LCD Display

- level 1
 - a) The first line displays the parameters(Power, Pgrid, Today and Total) and the values.
 - b) The second line shows the running status.
 - “Power” means the timely output power;
 - “Pgrid” means the power export to or import from the grid; (Positive value means the energy feeds into the grid, negative value means the energy used from the grid).
 - “Today” means the power generated within the day.
 - “Total” means the power generated until now.
- level 2
 - Long press any first-level parameter can enter the second-level “Status” parameter interface.
 - The user can also see other parameters, such as the “Language”, “Date Time”, “Settings” (need password), “Meter energy”, “Error Logs” of the inverter, and “About” (the user can watch the information of the inverter).
- level 3
 - Long press the second-level parameter can enter the corresponding third-level parameter interface.
 - a) Status: The user can see the U/I/P parameters of the grid and the PV, such as the “Ugrid”, “Igrid”, “PF value” of the grid, and the “Usolar”, “Isolar” and “Psolar” of the PV.
 - b) Language: This inverter provides several languages for the customer to choose.
 - c) Date Time: The user can set the date and time of the inverter.
 - d) Settings: Entering the installer password, the LCD screen will show the next page of configurable function parameters.
 - (1) Safety: The user can set the right safety standard here.
 - (2) Export Control: With this function the inverter can control energy exported to the grid. Whether having this function is based on user’s wishes.
 - (3) DRM Function (This function is mainly for Australia.) : User can choose whether using the DRM function or not.

Note!
 The user should confirm any function setting by long press the “Up” button. If no operation is performed, the LCD screen would return to the home interface within 27 seconds in which case the function isn’t set successfully.

7.3 LCD Function & Operation

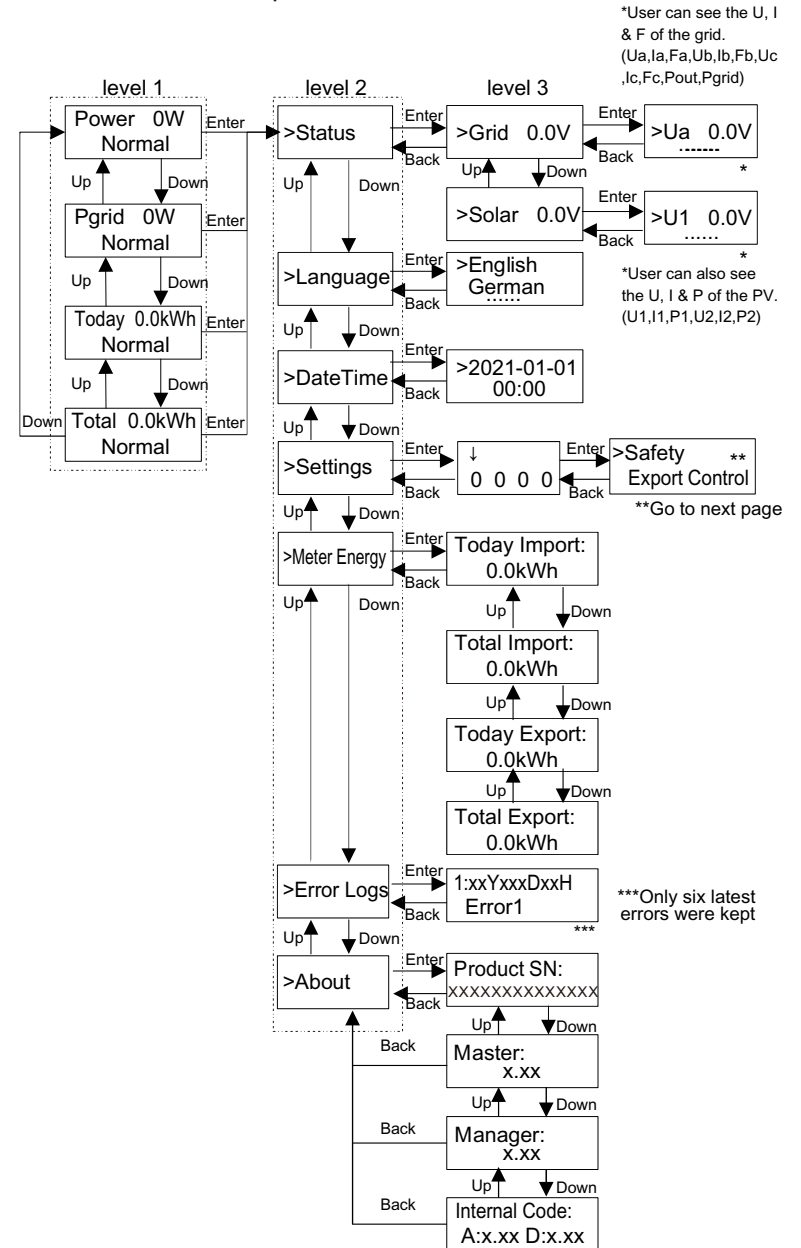

Settings page

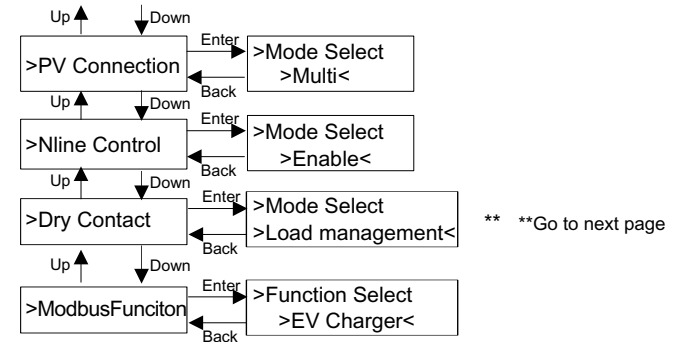
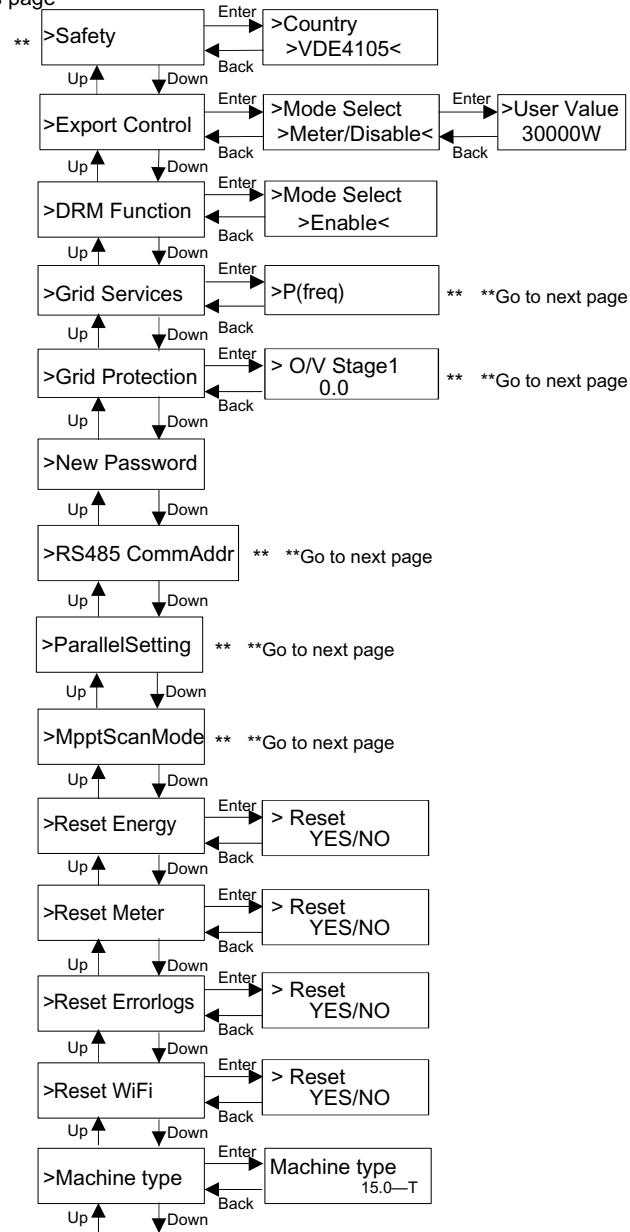

Grid Services and Grid Protection page

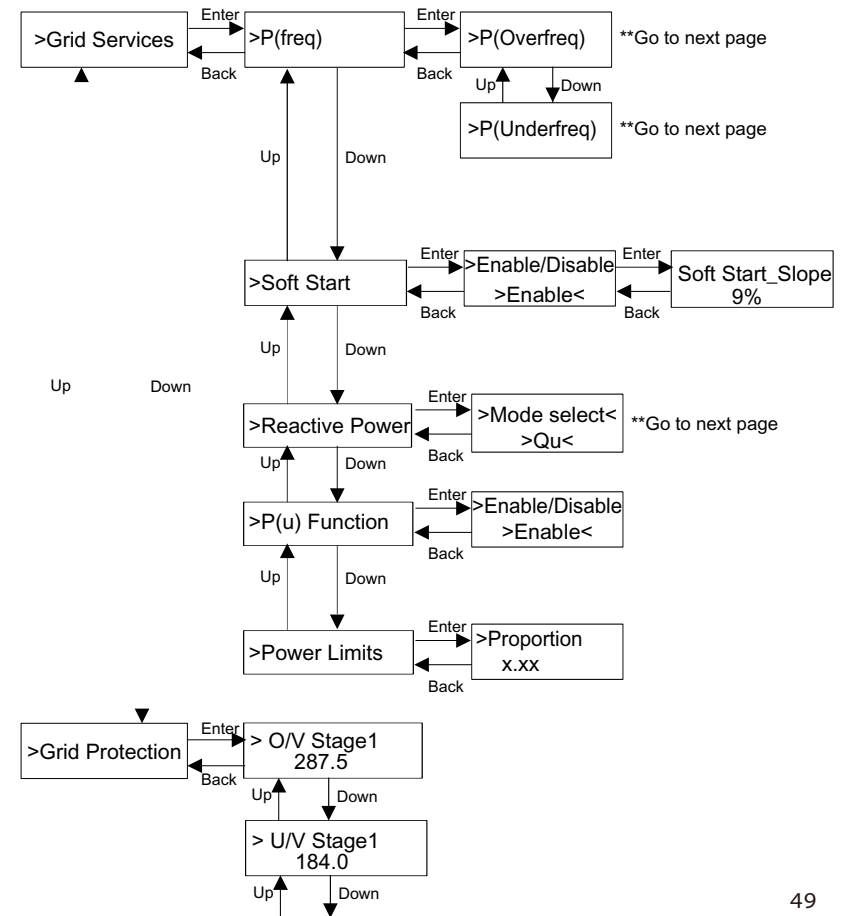

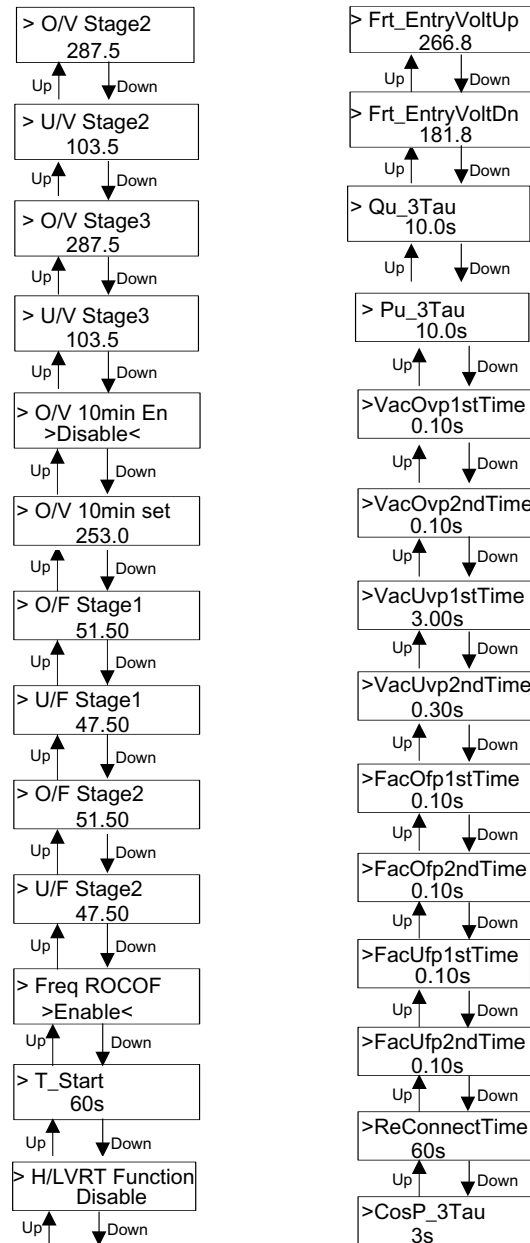

➤ LCD Digital Display

The main interface (Level 1) is the default interface, the inverter will automatically jump to this interface when the system started up successfully or not operated for a period of time.

The interface shows the following information. "Power" means the timely output power; "Pgrid" means the power export to or import from the grid; (Positive value means the energy feeds into the grid, negative value means the energy used from the grid); "Today" means the power generated within the day; "Total" means the power generated until now.

Press "Up" and "Down" to review the information.

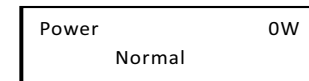

➤ Menu interface

The menu interface (Level 2) is a transfer interface for the user to get into other interface to finish the setting or get the information.

-User can get into this interface by long pressing "Down" button when LCD displays the main interface.

-User can select by moving the cursor with function button, and long press "Down" to confirm.

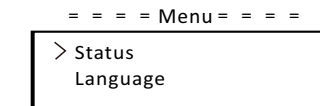

• Status

The status function contains two aspects, the grid and the solar.

Press "Up" and "Down" to select and long press "Down" to confirm the selection, long press "Up" to return to Menu.

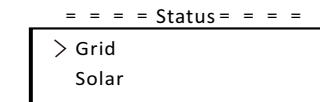

a) Grid

This status shows the current condition of the AC output port of the inverter, such as voltage, current, output power and grid power. "Pout" measures the output of the inverter, "Pgrid" measures power export to or import from the grid. Positive value means the power feeds into the grid, negative value means the power used from the grid.

Press "Up" and "Down" button to review the parameter, long press "Up" to return to Status .

= = = = Grid = = = =

> Ua	0.0V
Ia	0.0A

*
*

b) Solar

This status shows the real time PV condition of the system, such as input voltage, current and power situation of each PV input. Press "Up" and "Down" button to review parameter, long Press "Up" to return to Status.

= = = = Solar = = = =

U1	0.0V
I1	0.0A

*
*

• Language

The function refers to select a language from English, German, Polish, French, Portuguese etc.

= = = = Language = = = =

> English
German

• Date Time

This interface is for the user to set the system date and time. Increase or decrease the word by pressing "Up" or "Down" button. Press "Down" to confirm and alternate to next word. After all the words are confirmed. Long press "Down" to enter the date and time.

= = = =Date Time= = = =

>2021- 01 -01
00:00

• Settings

Setting function is used for setting the inverter for safety, connection, grid and so on.

* Password

The default password is "2014" for the installer, which only allows the installer to review and modify necessary settings complying to the local rules and regulations. If further advanced setting is required, please contact the distributor or us for assistance. We need to increase or decrease the word by pressing up or down button. Press "Down" to confirm an alternate to the next word. After word is confirmed, long press "Down" to enter password.

= = = = Password = = = =

∨	0	0	0	0
---	---	---	---	---

When inputting the password, the information of the LCD interface is shown as below.

= = = = Settings = = = =

> Safety
Export Control

a) Safety

The user can set the safety standard here according to different countries and grid tied standards. There are several standards for choice (May change without notice). In addition, the user has an "UserDefined" option which allows the user to customize relevant parameters within a wider range.

= = = = Safety = = = =

> country
VDE4105

b) Export Control

With this function the inverter can control energy exported to the grid. Whether having this function is based on user's wishes.

Choose "Meter" in "Meter/Disable" means user must install a meter to monitor energy exported to the grid. There are user value and factory value. The factory value is default which can not be changed by user. The user value set by installer must be less than the factory value and within the range of 0 kW to 30 kW.

Choose "Disable" means the function will be shut off.

Press "Up" and "Down" button to select and long press "Down" to confirm.

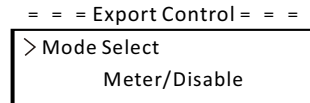

c) DRM Function

Installer can choose "Enable" to control the inverter's power off through the external communication.

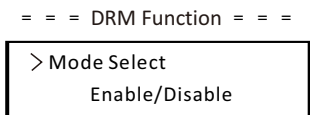

d) Grid Services

Usually end user do not need to set the grid parameters. All default value have been set before leaving factory according to safety rules.

If reset is needed, any changes should be made according to the requirements of local grid.

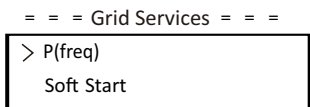

*
*

1. = = = P(freq) = = =

> P(Overfreq)
P(Underfreq)

If reset is needed, any changes should be made according to the requirements of local grid.

2. = = = Soft Start = = =

> Enable/Disable
>Disable <

If reset is needed, any changes should be made according to the requirements of local grid.

3.

Soft Start_Slope
9%

If set as shown, 9 percent of the rated power increase per minute.

4-1. = = = Reactive Power = = =

> Mode Select
>Off <

If reset is needed, any changes should be made according to the requirements of local grid.

Mode Select	Comment
Off	-
Over-Excited	PF value
Under-Excited	PF value
PF(P)	PowerFactor1(2/3/4)
	PowerRatio1(2/3/4)
	EntryVolt
	ExitVolt
Q(u)	Q(u) PowerLockEn
	Q(u) LockIn
	Q(u) LockOut
	Q(u) GridV1/V2/V3/V4
Fix Q Power	Q Power

4-2. Reactive power control, Reactive standard curve $\cos \varphi = f(P)$

For VDE ARN 4105, curve $\cos \varphi = f(P)$ should refer to curve A. Default values of setting are as shown in curve A.
 For E 8001, curve $\cos \varphi = f(P)$ should refer to curve B. Default values of setting are as shown in curve B.

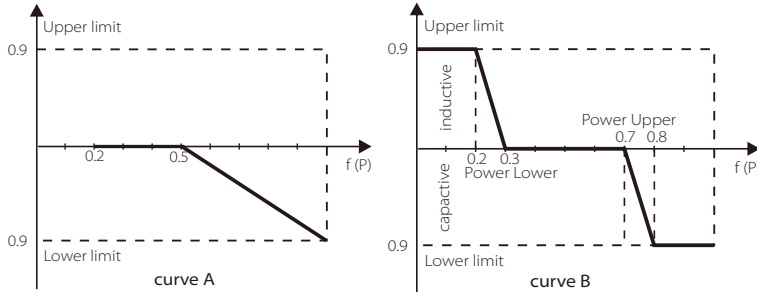

Reactive power control, Reactive standard curve $Q = f(V)$

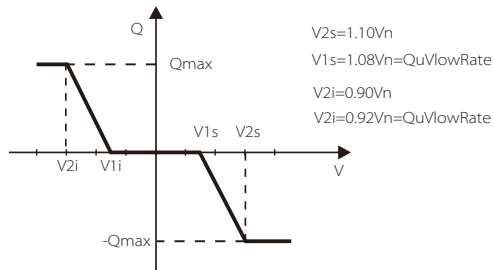

5. = = = P(u) Function = = =

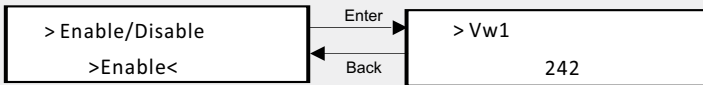

This function can limit the power. There are several values to be set.

6. = = = Power Limits = = =

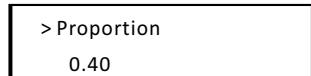

User can set the power limit here, the setting value is between 0.00 and 1.00.

e) Grid Protection

Usually end user do not need to set the grid Protection. All default value have been set before leaving factory according to safety rules.
 If reset is needed, any changes should be made according to the requirements of local grid.

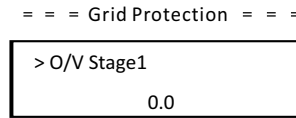

f) New Password

The user can set the new password here. We need to increase or decrease the word by pressing "Up" or "Down" button. Long press "Down" to confirm and alternate to next word. After word is confirmed, long press "Down" to reset the password.

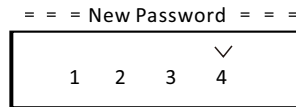

g) RS485 CommAddr

If "Enable" is selected, the inverter will communicate with the computer, through which the operating status of the inverter can be monitored. When multiple inverters are monitored by one computer, RS485 communication addresses of different inverters need to be set. The default address is "1".

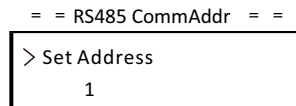

h) ParallelSetting

Make sure this setting is disabled (by default) all the time. (The series inverter does not support parallel connection without Datahub).

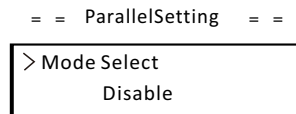

i) Mppt Scan Mode

There are four modes to be selected. "Off", "LowFreqScan", "MidFreqScan", "High FreqScan". It shows the frequency of PV panel scan. If "LowFreqScan" is selected, the inverter will scan the PV panel by low frequency.

```

= = Mppt Scan Mode = =
> Mode Select
  >Off<
    
```

j) Reset Energy

The user can clear the power energy by this function.

```

= = Reset Energy = =
> Reset
  >YES/NO<
    
```

k) Reset Meter

The user can clear the meter energy by this function. Press "Up" or "Down" button to select and long press "Down" to confirm. (The user can select "Yes" to reset meter if the user uses meter.)

```

= = Reset Meter = =
> Reset
  >YES/NO<
    
```

l) Reset Errorlog

The user can clear the errorlogs by this function. Press "Up" or "Down" button to select and long press "Down" to confirm.

```

= = Reset Errorlog = =
> Reset
  >YES/NO<
    
```

m) Reset WiFi

The user can restart the WiFi by this function.

```

= = Reset WiFi = =
> Reset
  >YES/NO<
    
```

n) Machine Type

The user can check the Machine Type by this function.

```

= = Machine Type = =
Machine Type
  15.0-T
    
```

o) PV Connection

The user can select the PV connection type by this function.

```

= = PV Connection = =
> Mode Select
  > Multi<
    
```

p) Nline Control

The user can enable or disable the Nline Control by this function. If the N wire of the AC side were connected, select "Enable"; if not connected, select "Disable".

```

= = Nline Control = =
> Mode Select
  > Enable/Disable<
    
```

q) Dry Contact

The user can use the Dry Contact to connect SG Ready heat pump by this function via Adapter Box.



There are three functions (Disable/Manual/Smart Save) which can be selected for Load Management. "Disable" means the heat pump is off. When "Manual" is selected the user can control the external relay to remain close or open manually. "Smart Save" mode can set the values of the heat pump's on/off time and conditions, operating modes. If the user uses the inverter dry contacts to control heat pump through Adapter box, please refer to the Adapter Box Quick Installation Guide to set the parameters here.

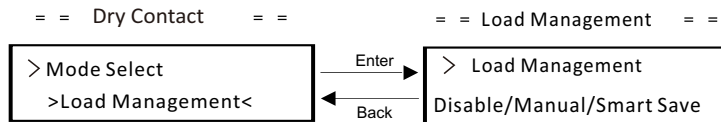

r) Modbus Function

Select "EV Charger" for communication with the EV-Charger, select "COM485" for communication with other devices.

==== Modbus Function =====

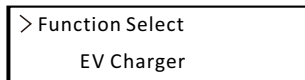

• Meter Energy

The user can check the import and export energy by this function. There are four parameters: "Today Import", "Total Import", "Today Export", "Total Export". Press "Up" and "Down" to review the values.

==== Meter Energy =====

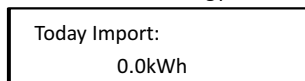

• Error Logs

The Error log contains error information happened. It can record six items at most. Press "Up" and "Down" button to review parameter. Long press "Up" to return to the main interface.

==== Error Logs =====

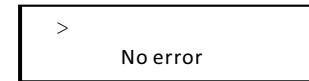

• About

This interface shows information of the inverter, include "Product SN", "Master", "Manager" and "Internal Code".

==== About =====

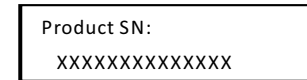

8 Troubleshooting

8.1 Troubleshooting

This section contains information and procedures for solving possible problems with the series inverters, and provides you with troubleshooting tips to identify and solve most problems that could occur with the series inverters.

This section will help you narrow down the source of any problems you may encounter. Please read the following troubleshooting steps.

Check warnings or fault messages on System Control Panel or Fault codes on the inverter information panel. If a message is displayed, record it before doing anything further.

Attempt the solution indicated in below table.

Faults	Diagnosis and Solution
TzFault	Over Current Fault. -Wait for about 10 seconds to check if the inverter is back to normal. -Disconnect the DC switch and restart the inverter. -Or seek help from us.
GridLostFault	Grid Lost Fault. -Check if the mains cable is loose. -Wait for a while and the system will reconnect when the utility is back to normal. -Or seek help from us.
GridVoltFault	Grid Voltage Out of Range. -Check if the mains cable is loose. -Wait for a while and the system will reconnect when the utility is back to normal. -Or seek help from us.
GridFreqFault	Grid Frequency Out of Range. -Wait for a while and the system will reconnect when the utility is back to normal. -Or seek help from us.
PV VoltFault	PV Voltage Fault. -Check whether the PV is overvoltage. -Or seek help from us.
BusVoltFault	DC Bus Voltage Out of Normal Range. -Check if the PV input voltage is within the operating range of the inverter. -Disconnect PV wiring and reconnect. -Or seek help from us.

Faults	Diagnosis and Solution
GridVolt10MFault	Grid Overvoltage for Ten Minutes Fault. -The system will reconnect when the utility is back to normal. -Or seek help from us.
DclnJOCp	DCI Overcurrent Protection Fault. -Wait for a while to check if the inverter is back to normal. -Or seek help from us.
HardLimitFault	Hard Limit Fault (in Australian standard). -Wait for a while to check if the inverter is back to normal. -Or seek help from us.
SW OCP Fault	Software Overcurrent Protection Fault. -Wait for a while to check if the inverter is back to normal. -Disconnect PV and grid, then reconnect. -Or seek help from us.
ResidualOCP	Overcurrent Protection Fault. -Check the connections of the inverter. -Wait for a while to check if the inverter is back to normal. -Or seek help from us.
IsoFault	Isolation Fault. -Check the connections of the inverter. -Or seek help from us.
OverTempFault	Over Temperature Fault. -Check if the inverter and the ambient temperature exceeds the operating range. -Or seek help from us.
LowTempFault	Low Temperature Fault. -Check if the ambient temperature is too low. -Or seek help from us.
InternalComFault	Internal Communication Fault. -Restart the inverter to check if it is back to normal. -Update the ARM software or reburn the program. -Or seek help from us.
FanFault	Fan Fault. -Check whether the fan is faulty or damaged. -Or seek help from us.
AcTerminalOTP	AC Terminal Overtemperature Fault. -Check if the AC terminals are tightly connected. -Check if the ambient temperature exceeds the operating range. -Or seek help from us.

Faults	Diagnosis and Solution
EepromFault	DSP EEPROM Fault. -Disconnect PV wiring and reconnect. -Or seek help from us.
RcDeviceFault	Residual Current Device Fault. -Restart the inverter. -Update the ARM software or reburn the program. -Or seek help from us.
PvConnDirFault	PV Direction Fault. -Check if the PV+/- sides are connected correctly. -Or seek help from us.
GridRelayFault	Relay Fault. -Check the grid connection. -Restart the inverter. -Or seek help from us.
OtherDeviceFault	Model Incorrectly Set Fault. -Seek help from us.
Mgr EEPROM Fault	ARM EEPROM Fault. -Disconnect PV and grid, then reconnect. -Or seek help from us.
Meter Fault	Meter Fault. -Check the connection of the meter. -Check if the meter is in working order. -Or seek help from us.
Fan1 Warning	External Fan 1 Abnormal Warning. -Check if the fan is working. -Or seek help from us.
Fan2 Warning	External Fan 2 Abnormal Warning. -Check if the fan is working. -Or seek help from us.
PowerTypeFault	Power Type Fault. -Check the version of ARM and DSP. -Check the product SN number. -Or seek help from us.

- If the information panel of your inverter does not show the Fault light, check the following list to make sure that the present state of the installation allows proper operation of the unit.
 - Is the inverter located in a clean, dry, adequately ventilated place?
 - Have the DC input breakers been opened?
 - Are the specification and length of the cables suitable?
 - Are the input and output connections and wiring in good condition?
 - Are the configuration settings correct for your particular installation?

Contact our Customer Service for further assistance. Please be prepared to describe details of your system installation and provide model and serial number of the inverter.

8.2 Routine Maintenance

Inverters do not need any maintenance or correction in most cases, but if the inverter often loses power due to overheating, this can be attributed to the following reason:

- The cooling fins on the rear of the inverter are covered by dirt. Clean the cooling fins with a soft dry cloth or brush if necessary. Only trained and authorized professional personnel who are familiar with the requirements of safety is allowed to perform servicing and maintenance work.

► Safety checks

Safety checks should be performed at least every 12 months by manufacturer's qualified person who has adequate training, knowledge, and practical experience to perform these tests. The data should be recorded in an equipment log. If the device is not functioning properly or fails any of test, the device has to be repaired. For safety check details, refer to this manual, section 2 Safety instruction and EC Directives.

► Maintain periodically

Only qualified personnel may perform the following works. During the process of using the inverter, the manage person shall examine and maintain the machine regularly. The concrete operations are as follows.

1. Check that if the cooling fins on the rear of the inverter are covered by dirt, and the machine should be cleaned and absorbed dust when necessary. This work shall be performed from time to time.
2. Check that if the indicators of the inverter are in normal state, check if the keys of the inverter are in normal state, check if the display of the inverter is normal. This check should be performed at least every 6 months.
3. Check that if the input and output wires are damaged or aged. This check should be performed at least every 6 months.
4. Clean the inverter panels and check their security. This should be carried out at least every 6 months.

9 Decommissioning

9.1 Dismantling the Inverter

- Disconnect the inverter from DC Input and AC output.
- Wait for at least 5 minutes for de-energizing.
- Disconnect communication and optional connection wirings.
- Remove the inverter from the bracket.
- Remove the bracket if necessary.



Warning!

Only dismantle the inverter after it is powered off for at least 5 minutes, otherwise there is a risk of electric shock!

9.2 Packaging

If possible, please pack the inverter with the original packaging.

If it is no longer available, you can also use an equivalent carton that meets the following requirements.

- Suitable for loads more than 30 kg.
- Can be fully closed

9.3 Storage and Transportation

Store the inverter in dry place where ambient temperatures are always between $-30^{\circ}\text{C} \sim +60^{\circ}\text{C}$. Keep less than 6 cartons in one stack during the storage and transportation.

9.4 Waste Disposal

When the inverter or other related components need to be disposed, have it carried out according to local waste handling regulations. Please be sure to deliver wasted inverters and packing materials to certain site where can assist relevant department to dispose and recycle.

10 Disclaimer

The inverters shall be transported, used and operated under restricted conditions. We will not provide any service, technical support or compensation in case of the following circumstances, including but not limited to:

- The inverter is damaged by force majeure (such as earthquake, flooding, thunderstorm, lighting, fire hazard, volcanic eruption, etc.);
 - The inverter's warranty is expired, but not extended;
 - The inverter's SN, warranty card or invoice cannot be provided;
 - The inverter is damaged by man-made cause;
 - The inverter is used or operated against any items in local policy;
 - The installation, configuration and commissioning of the inverter doesn't meet the requirements mentioned in this manual;
 - The inverter is installed, refitted or operated in improper ways;
 - The inverter is installed, operated under improper environment or electrical condition;
 - The inverter is changed, updated or disassembled on hardware or software without authority from us;
 - The communication protocol from other illegal channels is used; and
 - The monitoring or control system is used without authority from us.
- SolaX reserves the right for the final explanation.

Appendix: Lockable DC Switch

There are two kinds of DC switch for the series inverters:

- Unlockable DC switch (without lock);
- Lockable DC switch (with lock).

a. States of the lockable DC switch

For the lockable DC switch, there are 3 states: ON, OFF and OFF+Lock and the default state is OFF.

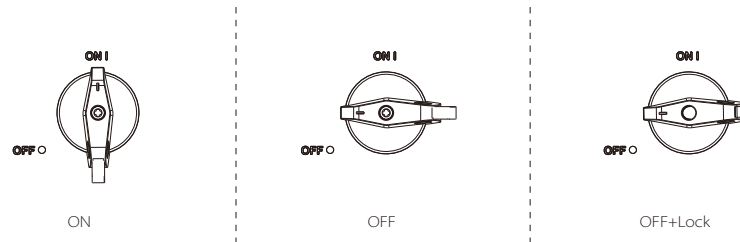

b. Operation of the lockable DC switch

- To turn on the lockable DC switch:
Rotate from OFF state to ON state.

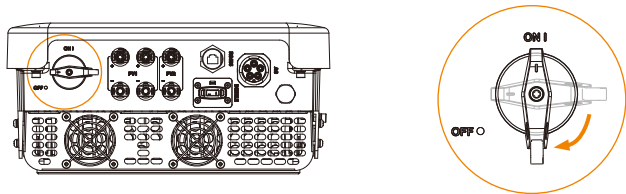

- To turn off the lockable DC switch:
Rotate from ON state to OFF state.

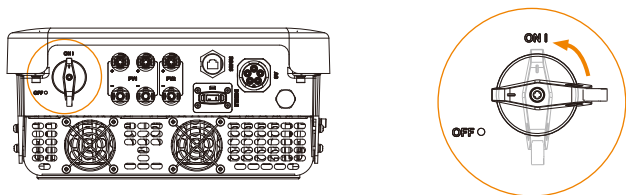

- To lock the lockable DC switch:
Make sure the DC switch is OFF state, push in the buckle as shown below, and then secure it with a lock (Please prepare a lock in advance.)

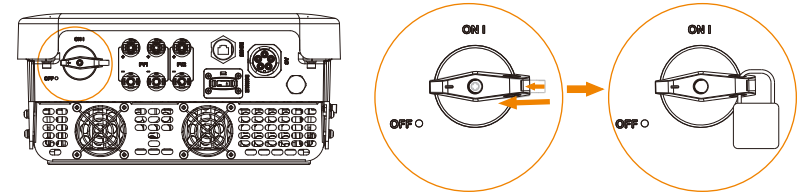

- To unlock the lockable DC switch:
Remove the lock and wait for it to return to OFF state.

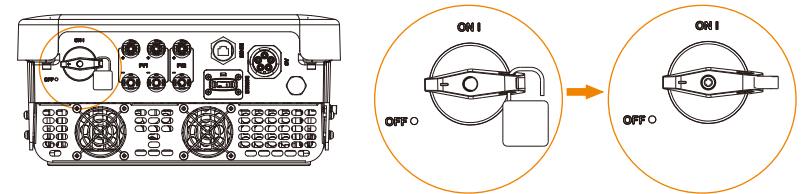

Warranty Registration Form



For Customer (Compulsory)

Name Country

Phone Number Email

Address

State Zip Code

Product Serial Number

Date of Commissioning

Installation Company Name

Installer Name Electrician License No.

For Installer

Module (If Any)

Module Brand

Module Size(W)

Number of String Number of Panel Per String

Battery (If Any)

Battery Type

Brand

Number of Battery Attached

Date of Delivery Signature

Please visit our warranty website: <https://www.solaxcloud.com/#/warranty> to complete the online warranty registration or use your mobile phone to scan the QR code to register.

For more detailed warranty terms, please visit SolaX official website: www.solaxpower.com to check it.





PLEASE REGISTER THE WARRANTY IMMEDIATELY AFTER INSTALLATION!
GET YOUR WARRANTY CERTIFICATE FROM SOLAX!
KEEP YOUR INVERTER ONLINE & WIN SOLAX POINTS!

1

Open your camera app and point your device at the QR code



2

Wait for the camera to recognize the QR code



3

Click banner or notification when it appears on the screen



4

Warranty registration page will be loaded automatically

