



X1-Hybrid-LV

3.0 KW / 3.7 KW / 4.0 KW / 4.6 KW /
5.0 KW / 6.0 KW

Installation Manual

Version 4.0

www.solaxpower.com



Download in the QR Code or
at <http://kb.solaxpower.com/>











Table of Contents

Safety.....	1
Sicherheit.....	3
Sécurité.....	5
Seguridad.....	7
Segurança	9
Veiligheid	11
Sicurezza	13
Bezpieczeństwo.....	15
Bezpečnost.....	17
Säkerhet.....	19
Siguranță.....	21
Безопасност.....	23
Sikkerhed.....	25
Ασφάλεια.....	27
Ohutus.....	29
Turvallisuus.....	31
Sigurnost.....	33
Biztonság.....	35
Sauga.....	37
Drošība.....	39
Bezpečnosť.....	41
Varnost.....	43
Güvenlik.....	45
Segurança	47
Installation.....	49

General Notice

1. Contents may be periodically updated or revised. SolaX reserves the right to make improvements or changes in the product(s) and the program(s) described in this manual without the prior notice.
2. The installation, maintenance and grid-related setting can only be performed by qualified personnel who:
 - Are licensed and/or satisfy state and local jurisdiction regulations;
 - Have good knowledge of this manual and other related documents.
3. Before installing the device, carefully read, fully understand and strictly follow the detailed instruction of the user manual and other related regulations. SolaX shall not be liable for any consequences caused by the violation of the storage, transportation, installation, and operation regulations specified in this document and the user manual.
4. Use insulated tools when installing the device. Individual protective tools must be worn during installation, electrical connection and maintenance.
5. Please visit the website www.solaxpower.com of SolaX for more information.

Descriptions of Labels

	CE mark of conformity		TUV certification
	Caution, risk of electric shock		Caution, risk of danger
	Read the enclosed documentations		Do not dispose of the inverter together with household waste.
	Caution, hot surface		
	Additional grounding point		
	Do not operate this inverter until it is isolated from mains and on-site PV generation suppliers.		
	Danger of high voltage. Do not touch live parts for 5 minutes after disconnection from the power sources.		

 DANGER!**Lethal danger from electrical shock due to the inverter**

- Only operate the inverter when it is technically faultless. Otherwise, electric shock or fire may occur.
- Do not open the enclosure in any case without authorization from SolaX. Unauthorized opening will void the warranty and cause lethal danger or serious injury due to electric shock.

 DANGER!**Lethal danger from electrical shock due to the PV**

- When exposed to sunlight, high DC voltage will be generated by PV modules. Death or lethal injuries will occur due to electric shock.
- Never touch the positive or negative pole of PV connecting device. Touching both of them at the same time is prohibited as well.
- Do not ground the positive or negative pole of the PV modules.
- Only qualified personnel can perform the wiring of the PV panels.

 WARNING!**Risk of personnel injury or inverter damage**

- During operation, do not touch any parts other than DC switch and LCD panel of the inverter.
- Never connect or disconnect the AC and DC connectors when the inverter is running.
- Turn off the AC and DC power and disconnect them from the inverter, wait for 5 minutes to fully discharge the voltage before attempting any maintenance, cleaning or working on any circuits connected.
- Make sure that the input DC voltage \leq Maximum DC input voltage of the inverter. Overvoltage may cause permanent damage to the inverter, which is NOT covered by the warranty.

 CAUTION!

- Keep children away from the inverter.
- Pay attention to the weight of the inverter. Personal injuries may be caused if not handled properly.











NOTICE!

- If an external RCD is required by local regulations, check which type of RCD is required for relevant electric codes. It is recommended to use a Type-A RCD with the value of 300 mA.
- All the product labels and nameplate on the inverter shall be maintained clearly visible.

Allgemeiner Hinweis

1. Inhalt kann regelmäßig aktualisiert oder überarbeitet werden. SolaX behält sich das Recht vor, Verbesserungen oder Änderungen an dem/den in diesem Handbuch beschriebenen Produkt(en) und Programm(en) ohne vorherige Ankündigung vorzunehmen.
2. Die Installation, Wartung und Netz-bezogene Einstellung darf nur von qualifiziertem Personal durchgeführt werden, das:
 - als solche zugelassen sind und/oder die Vorschriften der staatlichen und lokalen Gesetzgebung erfüllen;
 - gute Kenntnisse dieses Handbuchs und anderer damit zusammenhängender Dokumente haben.
3. Lesen Sie vor der Installation des Geräts die ausführlichen Anweisungen des Benutzerhandbuchs und anderer damit zusammenhängender Vorschriften sorgfältig durch, machen Sie sich mit ihnen vertraut und befolgen Sie sie genau. SolaX haftet nicht für Folgen, die durch die Verletzung der in diesem Dokument und im Benutzerhandbuch angegebenen Lager-, Transport-, Installations- und Betriebsvorschriften entstehen.
4. Benutzen Sie bei der Installation des Geräts isolierte Werkzeuge. Bei der Installation, dem elektrischen Anschluss und der Wartung muss individuelle Schutzausrüstung getragen werden.
5. Besuchen Sie bitte die Website www.solaxpower.com von SolaX für weitere Informationen.

Beschreibungen der Etiketten

	CE-Kennzeichnung		TÜV-Zertifikat
	Vorsicht, Stromschlaggefahr		Vorsicht, Gefahrenrisiko
	Lesen Sie die beigefügten Dokumente		Entsorgen Sie den Wechselrichter nicht mit dem Hausmüll
	Vorsicht, heiße Oberfläche		
	Zusätzlicher Erdungspunkt		
	Betreiben Sie diesen Wechselrichter erst, wenn er vom Stromnetz und von den PV-Erzeugern vor Ort getrennt ist.		
	Hochspannungsgefahr. Berühren Sie keine stromführenden Teile für 5 Minuten nach der Trennung von den Stromquellen.		

⚠ GEFAHR!**Tödliche Gefahr durch Stromschlag durch den Wechselrichter**

- Betreiben Sie den Wechselrichter nur, wenn er technisch einwandfrei ist. Andernfalls besteht Stromschlag- oder Brandgefahr;
- Öffnen Sie das Gehäuse auf keinen Fall ohne Genehmigung von SolaX. Eigenmächtiges Öffnen führt zum Verlust der Garantie und kann zu tödlichen Gefahren oder schweren Verletzungen durch Stromschlag führen.

⚠ GEFAHR!**Tödliche Gefahr durch Stromschlag aufgrund der PV**

- Bei Sonneneinstrahlung wird von der PV-Anlage eine hohe Gleichspannung erzeugt. Tod oder tödliche Verletzungen durch Stromschlag sind die Folge.
- Berühren Sie niemals den positiven oder negativen Pol des PV-Anschlussgeräts. Auch das gleichzeitige Berühren der beiden ist untersagt.
- Erden Sie nicht den positiven oder negativen Pol der PV-Module.
- Die Verkabelung der PV-Paneele darf nur von qualifiziertem Personal durchgeführt werden.

⚠ WARNUNG!**Gefahr von Personenschäden oder Beschädigung des Wechselrichters**

- Berühren Sie während des Betriebs keine anderen Teile als den Gleichstrom-Schalter und den LCD-Bildschirm.
- Verbinden oder trennen Sie niemals die AC- und DC-Verbindungen, wenn der Wechselrichter in Betrieb ist.
- Schalten Sie die Wechsel- und Gleichstromversorgung aus und trennen Sie sie vom Wechselrichter, warten Sie 5 Minuten, um die Spannung vollständig zu entladen, bevor Sie Wartungs- oder Reinigungsarbeiten durchführen oder an den angeschlossenen Stromkreisen arbeiten.
- Prüfen Sie, ob die Eingangs-Gleichspannung \leq der maximalen Eingangsspannung des Wechselrichters beträgt. Eine Überspannung kann zu dauerhaften Schäden am Wechselrichter führen, die NICHT durch die Garantie abgedeckt sind.

⚠ VORSICHT!

- Halten Sie Kinder vom Wechselrichter fern.
- Achten Sie auf das Gewicht des Wechselrichters. Bei unsachgemäßer Handhabung kann es zu Personenschäden kommen.











HINWEIS!

- Wenn ein externer FI-Schutzschalter gemäß den örtlichen Vorschriften erforderlich ist, prüfen Sie, welche Art von FI-Schutzschalter gemäß den einschlägigen Elektrovorschriften erforderlich ist. Es wird empfohlen, einen FI-Schutzschalter vom Typ A mit einem Wert von 300 mA zu benutzen.
- Alle Produktetiketten und das Typenschild des Wechselrichters müssen gut sichtbar bleiben.

Avis général

1. Le contenu peut être périodiquement mis à jour ou révisé. SolaX se réserve le droit d'apporter des améliorations ou des modifications au(x) produit(s) et au(x) programme(s) décrit(s) dans ce manuel sans préavis.
2. L'installation, la maintenance et le réglage lié au réseau ne peuvent être effectués que par du personnel qualifié qui:
 - sont agréés et/ou satisfont aux exigences de la réglementation nationale et locale ;
 - ont une bonne connaissance de ce manuel et des autres documents connexes.
3. Avant d'installer l'appareil, lisez attentivement, comprenez parfaitement et suivez strictement les instructions détaillées du manuel d'utilisation et d'autres réglementations connexes. SolaX ne sera pas responsable des conséquences causées par la violation de la réglementation concernant le stockage, le transport, l'installation et l'exploitation spécifiées dans ce document et le manuel d'utilisation.
4. Utiliser des outils isolés lors de l'installation de l'appareil. Des outils de protection individuels doivent être portés lors de l'installation, du raccordement électrique et de la maintenance.
5. Veuillez visiter le site Web www.solaxpower.com de SolaX pour obtenir de plus amples informations.

Descriptions des étiquettes

	Marquage CE de conformité		Homologation TÜV
	Attention, risque de choc électrique		Attention, risque de danger
	Lire la documentation jointe		Ne pas jeter l'onduleur avec les ordures ménagères
	Attention, surface chaude		
	Point de mise à la terre supplémentaire		
	Ne pas faire fonctionner cet onduleur tant qu'il n'est pas isolé du secteur et des fournisseurs de production PV sur site.		
	Risque de haute tension. Ne pas toucher pas les pièces sous tension avant un délai de 5 minutes après la déconnexion des sources d'alimentation.		

⚠ DANGER!**Danger de mort par choc électrique dû à l'onduleur**

- N'exploitez l'onduleur que s'il est techniquement irréprochable. Sinon, un choc électrique ou un incendie pourrait se produire.
- Ne jamais ouvrir le boîtier sans l'autorisation de SolaX. L'ouverture non autorisée annulera la garantie et peut entraîner un danger mortel ou des blessures graves par choc électrique.

⚠ DANGER!**Danger de mort par choc électrique dû au PV**

- Lors d'une exposition à la lumière du soleil, une tension continue élevée sera générée par le générateur photovoltaïque. La mort ou des blessures mortelles se produiront en raison d'un choc électrique.
- Ne jamais toucher le pôle positif ou négatif du dispositif de connexion PV. Il est également interdit de toucher les deux en même temps.
- Ne pas mettre à la terre le pôle positif ou négatif des modules PV.
- Seul un personnel qualifié peut effectuer le câblage des panneaux PV.

⚠ AVERTISSEMENT!**Risque de blessures corporelles ou de dommages à l'onduleur**

- Pendant le fonctionnement, ne touchez aucune pièce autre que l'interrupteur CC et le panneau LCD.
- Ne jamais brancher ni débrancher les fiches CA et CC lorsque l'onduleur fonctionne.
- Coupez l'alimentation CA et CC et déconnectez-les de l'onduleur, attendez 5 minutes pour décharger complètement la tension avant de tenter toute maintenance, nettoyage ou travail sur les circuits connectés.
- S'assurer que la tension d'entrée CC soit \leq à la tension d'entrée CC nominale maximale de l'onduleur. Une surtension peut causer des dommages permanents à l'onduleur, ce qui n'est PAS couvert par la garantie.

⚠ ATTENTION!

- Tenir les enfants éloignés de l'onduleur.
- Prêter attention au poids de l'onduleur. Des blessures personnelles peuvent être causées si le produit n'est pas manipulé correctement.











PRUDENCE!

- Si un disjoncteur externe est requis par les réglementations locales, vérifiez quel type de disjoncteur est requis pour les codes électriques pertinents. Il est recommandé d'utiliser un disjoncteur de type A avec une valeur de 300 mA.
- Toutes les étiquettes de produit et la plaque signalétique de l'onduleur doivent rester clairement visibles.

Aviso general

1. Los contenidos pueden actualizarse o revisarse periódicamente. SolaX se reserva el derecho de realizar cambios o mejoras en los productos y programas descritos en el presente manual sin previo aviso.
2. La instalación, el mantenimiento y la configuración relacionada con la red solo pueden ser realizados por personal cualificado que:
 - Tienen licencia o cumplen con las regulaciones de la jurisdicción estatal y local.
 - Tienen un buen conocimiento del presente manual y otros documentos relacionados.
3. Antes de instalar el dispositivo, lea con atención, comprenda bien y siga estrictamente las instrucciones detalladas del manual de usuario y otras normas relacionadas. SolaX no será responsable de las consecuencias causadas por el incumplimiento de las normas de almacenamiento, transporte, instalación y funcionamiento especificadas en este documento y el manual de usuario.
4. Utilice herramientas aisladas cuando instale el dispositivo. Se deben usar herramientas de protección individual durante la instalación, la conexión eléctrica y el mantenimiento.
5. Para obtener más información, visite el sitio web de SolaX www.solaxpower.com.

Descripciones de etiquetas

	Marcado CE de conformidad		Certificación TÜV
	Precaución: riesgo de descarga eléctrica		Precaución: riesgo de peligro
	Lea la documentación anexa		No deseche el inversor con la basura doméstica.
	Precaución: superficie caliente		
	Punto de conexión a tierra adicional		
	No utilice este inversor hasta que esté aislado de la red y equipo de suministro FV in situ.		
	Peligro de alto voltaje. No toque las partes activas durante los 5 minutos posteriores a la desconexión de las fuentes de alimentación.		

⚠ PELIGRO!**Peligro de muerte por descarga eléctrica a causa del inversor**

- Utilice el inversor únicamente cuando esté perfecto desde el punto de vista técnico. De lo contrario, podría producirse una descarga eléctrica o un incendio.
- En ningún caso, abra la caja sin autorización de SolaX. La apertura no autorizada anulará la garantía y puede causar peligro de muerte o lesiones graves por descarga eléctrica.

⚠ PELIGRO!**Peligro letal por descarga eléctrica debido a la FV**

- Cuando se expone a la luz solar, el conjunto FV genera una alta tensión de CC. Una descarga eléctrica conllevará lesiones letales o la muerte.
- Nunca toque ninguno de los polos del dispositivo de conexión FV. Esto incluye el polo positivo, negativo o ambos al mismo tiempo.
- No haga la toma de tierra desde el polo positivo o negativo del módulo FV.
- Solo el personal calificado puede realizar el cableado de los paneles FV.

⚠ ADVERTENCIA!**Riesgo de lesiones personales o daños en el inversor**

- Durante el funcionamiento, no toque ninguna pieza que no sea el interruptor de CC y el panel LCD.
- Nunca conecte o desconecte los conectores de CA y CC cuando el inversor esté en funcionamiento.
- Antes de realizar cualquier tarea de mantenimiento, limpieza o trabajo en los circuitos conectados, Apague la alimentación de CA y CC, y desconéctelas del inversor, espere 5 minutos para que se descargue completamente la tensión.
- Asegúrese de que la tensión de CC de entrada \leq Tensión nominal máxima de entrada de CC del inversor. La sobretensión puede provocar daños permanentes en el inversor, que NO están cubiertos por la garantía.

⚠ PRECAUCIÓN!

- Mantenga a los niños alejados del inversor
- Preste atención al peso del inversor. Si no se maneja adecuadamente, se pueden provocar lesiones personales.

AVISO!











- Si la legislación local exige un RCD externo, compruebe qué tipo de RCD es necesario para el código eléctrico pertinente. Se recomienda utilizar un RCD de tipo A con un valor de 300 mA.
- Todas las etiquetas del producto y la placa de características del inversor deberán mantenerse claramente visibles.

Segurança

Aviso geral

1. O conteúdo pode ser atualizado ou revisto periodicamente. A SolaX reserva-se ao direito de fazer melhorias ou alterações no(s) produto(s) e no(s) programa(s) descrito(s) neste manual sem aviso prévio.
2. A instalação, manutenção e configuração relacionada com a rede só podem ser executadas por pessoal qualificado que:
 - São licenciados e/ou atendem aos regulamentos da jurisdição estadual e local;
 - Têm um bom conhecimento deste manual e de outros documentos relacionados.
3. Antes de instalar o dispositivo, leia atentamente, compreenda completamente e siga rigorosamente as instruções detalhadas do manual do utilizador e outros regulamentos relacionados. A SolaX não se responsabiliza por quaisquer consequências causadas pela violação dos regulamentos de armazenamento, transporte, instalação e operação especificados neste documento e no manual do utilizador.
4. Utilize ferramentas com isolamento ao instalar o dispositivo. Os equipamentos de proteção individual devem ser usados durante a instalação, ligação elétrica e manutenção.
5. Visite o site www.solaxpower.com da SolaX para obter mais informações.

Descrições de rótulos

	Marca CE de conformidade		Certificação TUV
	Cuidado! Risco de choque elétrico		Cuidado! Risco de perigo
	Leia a documentação incluída		Não descarte o inversor junto com o lixo doméstico.
	Cuidado! Superfície quente		
	Ponto de ligação à terra adicional		
	Não opere este inversor até que ele esteja isolado da rede elétrica e dos painéis fotovoltaicos geradores de energia.		
	Perigo de alta tensão. Não toque nas partes energizadas por 5 minutos após a desconexão das fontes de alimentação.		

 **PERIGO!****Perigo letal de choque elétrico devido ao inversor**

- Opere o inversor somente quando ele estiver tecnicamente sem falhas. Caso contrário, pode ocorrer choque elétrico ou incêndio.
- Não abra o compartimento em nenhum caso sem autorização da SolaX. A abertura não autorizada anulará a garantia e pode causar perigo letal ou ferimentos graves devido a choque elétrico.

 **PERIGO!****Perigo letal de choque elétrico devido ao PV**

- Quando exposto à luz solar, a alta tensão CC será gerada pela série fotovoltaica. Morte ou ferimentos letais ocorrerão devido a choque elétrico.
- Nunca toque no polo positivo ou negativo do dispositivo de conexão fotovoltaica. Tocar os dois polos ao mesmo tempo também é proibido.
- Não ligue à terra o polo positivo e negativo dos módulos fotovoltaicos.
- Só pessoal qualificado pode executar a cablagem dos painéis fotovoltaicos.

 **AVISO!****Risco de ferimentos pessoais ou danos no inversor**

- Durante a operação, não toque em nenhuma peça que não seja o interruptor CC e o painel LCD.
- Nunca conecte ou desconecte os conectores CA e CC quando o inversor estiver em funcionamento.
- Desligue a alimentação CA e CC e desconecte-as do inversor, aguarde 5 minutos para descarregar totalmente a tensão antes de realizar qualquer manutenção, limpeza ou trabalho em qualquer circuito ligado.
- Certifique-se de que a tensão CC de entrada \leq Tensão de entrada CC máxima nominal do inversor. A sobretensão pode causar danos permanentes ao inversor, que NÃO são cobertos pela garantia.

 **CUIDADO!**

- Mantenha as crianças longe do inversor.
- Preste atenção ao peso do inversor. Ferimentos pessoais podem ser causados se o inversor não for manuseado adequadamente.











PONTA!

- Se um RCD externo for obrigatório perante a legislação local, verifique que tipo de RCD é exigido para os códigos de eletricidade relevantes. Recomenda-se usar um RCD Tipo A com o valor de 300 mA.
- Todas as etiquetas do produto e a placa de identificação no inversor devem ser mantidas claramente visíveis.

Algemene kennisgeving

1. De inhoud kan periodiek worden bijgewerkt of herzien. SolaX behoudt zich het recht voor om zonder voorafgaande kennisgeving verbeteringen of wijzigingen aan te brengen in de producten en de programma's die worden beschreven in deze handleiding.
2. De installatie, het onderhoud en de aan het net gerelateerde instellingen, mogen uitsluitend worden uitgevoerd door gekwalificeerd personeel dat:
 - Gecertificeerd zijn en/of voldoen aan de nationale en lokale regelgeving;
 - Goede kennis hebben van deze handleiding en andere gerelateerde documenten.
3. Voordat u het toestel installeert, moet u de gedetailleerde instructies in de gebruikershandleiding en andere verwante regelgeving zorgvuldig lezen, volledig begrijpen en strikt opvolgen. SolaX is niet aansprakelijk voor de gevolgen van het niet naleven van de voorschriften voor opslag, transport, installatie en gebruik die in dit document en in de gebruikershandleiding worden vermeld.
4. Gebruik geïsoleerd gereedschap bij het installeren van het apparaat. Tijdens de installatie, elektrische aansluiting en onderhoud moeten individuele beschermingsmiddelen worden gedragen.
5. Ga naar de website www.solaxpower.com van SolaX voor meer informatie.

Beschrijving van de etiketten

	CE-markering van overeenstemming		TUV-certificering
	Opgelet, risico op elektrische schokken		Opgelet, risico op gevaar
	Lees de bijgesloten documentatie		Gooi de omvormer niet samen met het huisvuil weg.
	Opgelet, heet oppervlak		
	Extra aardingspunt		
	Gebruik deze omvormer niet totdat deze is geïsoleerd van het lichtnet en PV-generatoren ter plaatse.		
	Hoogspanningsgevaar. Raak na het loskoppelen van de stroombronnen gedurende 5 minuten geen spanningvoerende delen aan.		

GEVAAR!

Levensgevaar door elektrische schok vanwege de omvormer

- Gebruik de omvormer alleen als deze technisch in orde is. Als dit niet het geval is, kunnen er elektrische schokken of brand ontstaan.
- Open de behuizing in geen geval zonder toestemming van SolaX. Het zonder toestemming openen van de behuizing doet de garantie vervallen en kan levensgevaar of ernstig letsel als gevolg van elektrische schokken veroorzaken.

GEVAAR!

Levensgevaar door elektrische schok als gevolg van de PV

- Bij blootstelling aan zonlicht wordt er een hoge DC-spanning gegenereerd door de PV-array. De dood of dodelijk letsel zal zich voordoen als gevolg van elektrische schokken.
- Raak nooit de positieve of negatieve pool van het PV-aansluitapparaat aan. Het is ook verboden om beide tegelijk aan te raken.
- Aard de positieve of negatieve pool van de PV-modules niet.
- Alleen gekwalificeerd personeel mag de bedrading van de PV-panelen uitvoeren.

WAARSCHUWING!

Risico op persoonlijk letsel of beschadiging van de omvormer

- Raak tijdens bedrijf geen andere onderdelen dan de DC-schakelaar en het LCD-paneel aan.
- Als de omvormer in bedrijf is, mogen de AC- en DC-connectoren nooit worden aangesloten of losgekoppeld.
- Schakel de AC- en DC-voeding uit en koppel ze los van de omvormer, wacht 5 minuten om de spanning volledig te ontladen alvorens onderhoud uit te voeren, de omvormer te reinigen of werkzaamheden uit te voeren aan aangesloten circuits.
- Zorg ervoor dat de DC-ingangsspanning \leq maximale nominale DC-ingangsspanning van de omvormer. Overspanning kan permanente schade aan de omvormer veroorzaken. Dit wordt NIET gedekt door de garantie.

ATTENTIE!

- Houd kinderen uit de buurt van de omvormer.
- Let op het gewicht van de omvormer. Er kan persoonlijk letsel ontstaan als de omvormer niet juist wordt behandeld.











ADVIES!

- Als een externe RCD (aardlekschakelaar) vereist is door de lokale regelgeving, controleer dan welk type RCD vereist is voor relevante elektrische codes. Het wordt aanbevolen om een Type-A RCD met een waarde van 300 mA te gebruiken.
- Alle productlabels en naamplaatjes op de omvormer moeten duidelijk zichtbaar blijven.

Avvisi generali

1. Il contenuto può essere soggetto periodicamente ad aggiornamenti o revisioni. SolaX si riserva il diritto di apportare migliorie o modifiche al(i) prodotto(i) e al(i) programma(i) descritti in questo manuale senza alcun preavviso.
2. L'installazione, la manutenzione e l'impostazione relativa alla rete possono essere eseguite esclusivamente da addetti qualificati, i quali:
 - sono in possesso di un'autorizzazione e/o agiscono nel rispetto delle normative nazionali e locali;
 - hanno una conoscenza approfondita di questo manuale o di altri documenti correlati.
3. Prima di installare il dispositivo, leggere attentamente, comprendere appieno e seguire scrupolosamente le istruzioni dettagliate del manuale dell'utente e le altre normative correlate. SolaX non sarà ritenuta responsabile per conseguenze che risultino dal mancato rispetto delle norme di conservazione, trasporto, installazione e funzionamento specificate in questo documento e nel manuale dell'utente.
4. Utilizzare utensili isolati nel corso dell'installazione del dispositivo. È necessario indossare dispositivi di protezione individuale durante gli interventi finalizzati all'installazione, al collegamento elettrico e alla manutenzione.
5. Si prega di visitare il sito web di SolaX www.solaxpower.com per maggiori informazioni.

Descrizioni delle etichette

	Marchio di conformità CE		Certificazione TÜV
	Attenzione, rischio di folgorazione		Attenzione, rischio di pericolo
	Leggere la documentazione in allegato		Non smaltire l'inverter come un normale rifiuto domestico.
	Attenzione, superficie ad alta temperatura		
	Punto di messa a terra aggiuntivo		
	Non mettere in funzione l'inverter finché non è stato isolato dalla rete e dai generatori FV in loco.		
	Pericolo di alta tensione. Non toccare parti sotto tensione nei cinque minuti successivi all'aver scollegato le fonti di alimentazione.		

 **PERICOLO!**

Pericolo di morte per scosse elettriche dovute all'inverter

- Utilizzare l'inverter solo quando è tecnicamente privo di difetti. In caso contrario, potrebbe verificarsi il rischio di folgorazione o incendio.
- Non aprire l'involucro dell'inverter in alcuna circostanza senza l'autorizzazione di SolaX. L'aprirlo in assenza di autorizzazione invaliderà la garanzia e può causare pericolo di morte o lesioni gravi per folgorazione.

 **PERICOLO!**

Pericolo di morte per scosse elettriche dovute ai pannelli fotovoltaici

- Quando è esposto al sole, il generatore FV produrrà alta tensione CC; Le scosse elettriche comporteranno la morte o ferite letali.
- Non toccare il polo positivo o quello negativo del dispositivo di connessione FV; evitare, inoltre, di toccarli contemporaneamente.
- Non mettere a terra il polo positivo o quello negativo dei moduli FV.
- Solo il personale qualificato può eseguire il cablaggio dei pannelli fotovoltaici.

 **AVVERTENZA!**

Rischio di lesioni personali o danni all'inverter

- Durante il funzionamento, non toccare parti diverse dall'interruttore CC e dal pannello LCD.
- Non collegare o scollegare connettori CA e CC quando l'inverter è in funzione.
- Spegnerne l'alimentazione CA e CC, quindi scollegarli dall'inverter, attendere cinque minuti perché la tensione si scarichi completamente, prima di procedere alla manutenzione, alla pulizia o ad interventi sui circuiti collegati.
- Assicurarsi che la tensione in ingresso CC sia pari o inferiore al valore nominale massimo dell'inverter. Una sovratensione potrebbe causare danni permanenti all'inverter non coperti da garanzia.

 **ATTENZIONE!**

- Tenere l'inverter lontano dalla portata dei bambini.
- Tenere in considerazione il peso dell'inverter; se non viene maneggiato adeguatamente, potrebbe causare lesioni personali.

AVVISO!











- Se i regolamenti locali obbligano all'utilizzo di un RCD esterno, verificare quale sia il tipo richiesto dal codice elettrico pertinente. Si consiglia l'utilizzo di un RCD di tipo A con valori di corrente pari a 300 mA.
- Tutte le etichette e la targhetta riportate sull'inverter devono essere mantenute in modo da essere perfettamente visibili.

Bezpieczeństwo

Uwaga ogólna

1. Treść może być co pewien czas aktualizowana lub zmieniana. Firma SolaX zastrzega sobie prawo do wprowadzania ulepszeń lub zmian w produktach i programach opisanych w niniejszej instrukcji bez uprzedniego powiadomienia.
2. Instalację, konserwację i konfigurację ustawień związanych z siecią mogą przeprowadzać wyłącznie wykwalifikowani pracownicy, którzy:
 - Posiadają odpowiednią licencję i/lub spełniają wymogi określone w przepisach krajowych i lokalnych;
 - Są obeznani z treścią niniejszej instrukcji i innych powiązanych dokumentów.
3. Przed zainstalowaniem urządzenia należy uważnie przeczytać i w pełni zrozumieć szczegółowe instrukcje określone w podręczniku użytkownika oraz innych powiązanych regulacjach i ściśle się do nich stosować. Firma SolaX nie ponosi odpowiedzialności za jakiegokolwiek skutki spowodowane naruszeniem zasad przechowywania, transportu, instalacji i obsługi określonych w niniejszym dokumencie oraz instrukcji obsługi.
4. Podczas instalowania urządzenia należy korzystać z izolowanych narzędzi. Podczas instalacji, podłączenia elektrycznego i konserwacji należy nosić indywidualne środki ochrony.
5. Więcej informacji można znaleźć na stronie internetowej firmy SolaX: www.solaxpower.com.

Opisy etykiet

	Znak zgodności CE		Certyfikat TUV
	Ostrożnie, ryzyko porażenia prądem		Ostrożnie, ryzyko niebezpieczeństwa
	Zapoznaj się z załączoną dokumentacją		Nie należy wyrzucać falownika razem z odpadami domowymi.
	Ostrożnie, gorąca powierzchnia		
	Dodatkowy punkt uziemienia		
	Nie należy używać tego falownika, dopóki nie zostanie on odizolowany od sieci zasilającej i dostawców energii fotowoltaicznej na miejscu.		
	Niebezpieczeństwo związane z wysokim napięciem. Nie wolno dotykać części pod napięciem przez 5 minut od momentu odłączenia od źródła zasilania.		

NIEBEZPIECZEŃSTWO!

Śmiertelne niebezpieczeństwo porażenia prądem z falownika

- Falownik należy obsługiwać wyłącznie, gdy jest w pełni sprawny technicznie. W przeciwnym razie może dojść do porażenia prądem lub pożaru.
- W żadnym wypadku nie wolno otwierać obudowy bez upoważnienia firmy SolaX. Nieuprawnione otwarcie spowoduje utratę gwarancji i może być spowodować śmiertelne niebezpieczeństwo lub poważne obrażenia w wyniku porażenia prądem.

NIEBEZPIECZEŃSTWO!

Śmiertelne niebezpieczeństwo porażenia prądem z instalacji fotowoltaicznej

- Pod wpływem promieniowania słonecznego w instalacji fotowoltaicznej powstaje wysokie napięcie prądu stałego. Porażenie prądem grozi śmiercią lub śmiertelnymi obrażeniami.
- Nie wolno dotykać dodatniego ani ujemnego bieguna urządzenia łączącego moduły fotowoltaiczne. Zabronione jest także dotykanie obu z nich jednocześnie.
- Nie należy uziemiać dodatniego ani ujemnego bieguna modułów fotowoltaicznych.
- Tylko wykwalifikowani pracownicy mogą wykonywać okablowanie paneli fotowoltaicznych.

OSTRZEŻENIE!

Ryzyko obrażeń ciała lub uszkodzenia falownika

- Podczas pracy nie wolno dotykać żadnych elementów innych niż przetwornik DC i panel LCD.
- Nigdy nie należy podłączać ani odłączać złączy AC i DC, gdy falownik pracuje; a także.
- Przed przystąpieniem do konserwacji, czyszczenia lub prac przy podłączonych obwodach należy Wyłączyć zasilanie AC i DC oraz odłączyć te obwody od falownika. odczekać 5 minut w celu całkowitego rozładowania napięcia.
- Upewnij się, że wejściowe napięcie prądu stałego \leq maksymalne znamionowe napięcie wejściowe prądu stałego falownika. Przepięcie może spowodować trwałe uszkodzenie falownika, które NIE jest objęte gwarancją.

PRZESTROGA!

- Nie wolno dopuszczać dzieci w pobliże falownika.
- Należy zwrócić uwagę na ciężar falownika. W przypadku niewłaściwego obchodzenia się może dojść do obrażeń ciała; ponadto.

UWAGA!











- Jeśli przepisy lokalne wymagają zastosowania zewnętrznego wyłącznika różnicowoprądowego, należy sprawdzić, jaki typ wyłącznika jest wymagany zgodnie z odpowiednimi przepisami elektrycznymi. Zaleca się stosowanie wyłącznika różnicowoprądowego RCD typu A o czułości 300 mA.
- Wszystkie etykiety produktu i tabliczka znamionowa na falowniku powinny być dobrze widoczne.

Bezpečnost

Obecné upozornění

1. Obsah může být pravidelně aktualizován nebo revidován. Společnost SolaX si vyhrazuje právo provádět vylepšení nebo změny v produktech a programech popsanych v této příručce bez předchozího upozornění.
2. Instalaci, údržbu a nastavení týkající se sítě může provádět pouze kvalifikovaný personál, který:
 - je licencován a/nebo splňuje státní a místní regulační předpisy;
 - je dobře seznámen s touto příručkou a dalšími souvisejícími dokumenty.
3. Před instalací zařízení si pozorně přečtete, plně pochopte a přísně dodržujte podrobné pokyny v uživatelské příručce a další související předpisy. Společnost SolaX nenes odpovědnost za žádné následky způsobené porušením skladovacích, přepravních, instalačních a provozních předpisů uvedených v tomto dokumentu a uživatelské příručce.
4. Při instalaci zařízení používejte izolované nástroje. Při instalaci, elektrickém připojení a údržbě je nutné nosit jednotlivé ochranné nástroje.
5. Navštivte prosím webovou stránku www.solaxpower.com společnosti SolaX pro více informací.

Popisy štítků

	Značka shody CE		Certifikace TUV
	Pozor, nebezpečí úrazu elektrickým proudem		Pozor, nebezpečí
	Přečtete si přiloženou dokumentaci.		Nelikvidujte měnič společně s domovním odpadem.
	Pozor, horký povrch		
	Další bod pro uzemnění		
	Neprovozujte tento střídač, dokud není izolován od sítě a místních dodavatelů FV generátoru.		
	Nebezpečí vysokého napětí Nedotýkejte se částí pod napětím po dobu 5 minut po odpojení od zdrojů energie.		

NEBEZPEČÍ!

Nebezpečí smrtelného úrazu elektrickým proudem v důsledku střídače

- Měníč provozujte pouze tehdy, je-li technicky bezvadný. Jinak může dojít k úrazu elektrickým proudem nebo požáru.
- V žádném případě neotevírejte kryt bez povolení společnosti SolaX. Neoprávněné otevření způsobí neplatnost záruky a způsobí smrtelné nebezpečí nebo vážné zranění v důsledku úrazu elektrickým proudem.

NEBEZPEČÍ!

Smrtelné nebezpečí úrazu elektrickým proudem v důsledku FV

- Při vystavení slunečnímu záření budou FV moduly generovat vysoké stejnosměrné napětí. V důsledku úrazu elektrickým proudem může dojít k usmrcení nebo smrtelnému zranění.
- Nikdy se nedotýkejte kladného nebo záporného pólu FV připojovacího zařízení. Je také zakázáno dotýkat se obou pólů současně.
- Neuzemňujte kladný ani záporný pól FV modulů.
- Zapojení FV panelů může provádět pouze kvalifikovaný personál.

VAROVÁNÍ!

Nebezpečí zranění osob nebo poškození střídače

- Během provozu se nedotýkejte jiných částí než vypínače stejnosměrného proudu a LCD panelu.
- Nikdy nepřipojujte ani neodpojujte konektory střídavého proudu ani konektory stejnosměrného proudu, když je střídač v chodu.
- Vypněte střídavé a stejnosměrné napájení a odpojte je od střídače, počkejte 5 minut, než se napětí úplně vybijí, než se pokusíte o jakoukoli údržbu, čištění nebo práci na připojených obvodech.
- Ujistěte se, že vstupní stejnosměrné napětí \leq DC vstupní stejnosměrné napětí střídače. Přepětí může způsobit trvalé poškození měniče, na které se NEVZTAHUJE záruka.

POZOR!

- Měníč udržujte mimo dosah dětí.
- Věnujte pozornost hmotnosti měniče. Při nesprávném zacházení může dojít ke zranění osob.











OZNÁMENÍ!

- Pokud místní předpisy vyžadují externí proudový chránič, zkontrolujte, jaký typ proudového chránič je vyžadován pro příslušné elektrické kódy. Doporučuje se použít proudový chránič typu A s hodnotou 300 mA.
- Všechny produktové štítky a typový štítek na střídači musí být dobře viditelné.

Allmänt meddelande

- Innehållet kan uppdateras eller revideras regelbundet. SolaX förbehåller sig rätten att göra förbättringar eller ändringar i produkten/produkterna och programmet/programmen som beskrivs i denna handbok utan föregående meddelande.
- Installation, underhåll och elnätsrelaterad inställning kan endast utföras av kvalificerad personal som:
 - Är licensierade och/eller uppfyller statliga och lokala jurisdiktionsbestämmelser;
 - Har god kännedom om denna handbok och andra relaterade dokument.
- Innan du installerar enheten, läs noggrant, förstå och följ noggrant de detaljerade anvisningarna i användarhandboken och andra relaterade regler. SolaX ansvarar inte för några konsekvenser som orsakas av brott mot lagrings-, transport-, installations- och driftsföreskrifterna som anges i detta dokument och användarhandboken.
- Använd isolerade verktyg när du installerar enheten. Individuell skyddsutrustning måste bäras under installation, elektrisk anslutning och underhåll.
- Besök webbplatsen www.solaxpower.com av SolaX för mer information.

Beskrivningar av etiketter

	CE-märke för överensstämmelse		TUV-certifiering
	Försiktighet, risk för elektrisk stöt		Försiktighet, risk för fara
	Läs bifogad dokumentation		Kassera inte växelriktaren tillsammans med hushållsavfallet.
	Försiktighet, het yta		
	Ytterligare jordningspunkt		
	Använd inte denna växelriktare förrän den är isolerad från elnätet och försörjningen från solcellsanläggningen.		
	Risk för högspänning. Rör inte vid spänningsförändrande delar under 5 minuter efter frånkoppling från strömkällorna.		



FARA!

Dödlig fara från elektriska stötar på grund av växelriktaren

- Använd endast växelriktaren när den är tekniskt felfri. Annars kan elektriska stötar eller brand uppstå.
- Öppna inte höljet under några omständigheter utan tillstånd från SolaX. Obehörig öppning upphäver garantin och orsakar dödlig fara eller allvarlig skada på grund av elektriska stötar.



FARA!

Dödlig fara från elektriska stötar på grund av solcellsanläggningen

- Vid exponering till solljus genereras hög DC-spänning av solcellsmoduler. Dödsfall eller dödliga skador kommer att uppstå på grund av elektrisk stöt.
- Rör aldrig vare sig den positiva eller negativa polen på anslutningsenheten för solcellsanläggningen. Att röra båda samtidigt är också förbjudet.
- Jorda inte den positiva eller negativa polen på solcellsmodulerna.
- Endast kvalificerad personal kan utföra inkopplingsarbete på solcellspanelerna.



VARNING!

Risk för personskada eller skador på växelriktaren

- Under drift, rör inte några andra delar än CD-omkopplare och LCD-panelen.
- Anslut eller koppla aldrig ur AC- och DC-kontakterna när växelriktaren är igång.
- Stäng av AC- och DC-försörjningen och koppla bort dem från växelriktaren, vänta i 5 minuter för att helt ladda ur spänningen innan du utför underhåll, rengöring eller arbete på anslutna kretsar.
- Se till att den ingående DC-spänning \leq maximal DC-spänning hos växelriktaren. Överspänning kan orsaka permanent skada på växelriktaren, som INTE täcks av garantin.



FÖRSIKTIGHET!

- Håll barn borta från växelriktaren.
- Var uppmärksam på växelriktarens vikt. Det kan leda till personskador de inte hanteras korrekt.











OBS!

- Om en extern jordfelsbrytare krävs enligt lokala bestämmelser, kontrollera vilken typ av jordfelsbrytare som krävs för relevanta elektriska bestämmelser. Det rekommenderas att använda en typ-A RCD med värdet 300 mA.
- Alla produktetiketter och typskylten på växelriktaren ska vara tydligt synliga.

Notă generală

1. Conținutul poate fi actualizat sau revizuit periodic. SolaX își rezervă dreptul de a aduce îmbunătățiri sau modificări produsului (produselor) și programului (programelor) descrise în acest manual fără notificare prealabilă.
2. Instalarea, întreținerea și setarea rețelei pot fi efectuate numai de personal calificat care:
 - Deține licență și/sau îndeplinește reglementările juridictionale de stat și locale;
 - Cunoaște bine acest manual și alte documente conexe.
3. Înainte de a instala dispozitivul, citiți cu atenție, înțelegeți pe deplin și urmați cu strictețe instrucțiunile detaliate din manualul de utilizare și alte reglementări aferente. Compania SolaX nu va fi responsabilă pentru nicio consecință cauzată de încălcarea regulamentelor de depozitare, transport, instalare și operare specificate în acest document și în manualul de utilizare.
4. Pentru instalarea dispozitivului, utilizați unelte izolate. În timpul instalării, conectării electrice și întreținerii trebuie purtate echipamente individuale de protecție.
5. Vizitați site-ul web www.solaxpower.com al SolaX pentru mai multe informații.

Descrierile etichetelor

	Marcaj de conformitate CE		Certificare TUV
	Atenție, risc de electrocutare		Atenție, risc de pericol
	Citiți documentațiile anexate		Nu aruncați invertorul împreună cu deșeurile menajere.
	Atenție, suprafață fierbinte		
	Punct suplimentar de împământare		
	Nu utilizați acest inverter până când nu este deconectat de la rețea și de la furnizorii de generare PV de la fața locului.		
	Pericol de înaltă tensiune. Nu atingeți părțile sub tensiune timp de 5 minute după deconectarea de la sursele de alimentare.		

PERICOL!

Pericol de deces cauzat prin electrocutare din cauza invertorului

- Utilizați invertorul numai dacă nu are defecțiuni tehnice. În caz contrar, poate apărea electrocutare sau incendiu.
- Nu deschideți în niciun caz carcasa fără autorizația SolaX. Deschiderea neautorizată va anula garanția și va cauza pericol letal sau vătămare gravă prin electrocutare.

PERICOL!

Pericol de deces prin electrocutare din cauza PV

- Atunci când sunt expuse la lumina soarelui, modulele fotovoltaice (PV) vor genera o tensiune de c.c. ridicată. Decesul sau răniurile letale vor fi cauzate prin electrocutare.
- Nu atingeți niciodată polul pozitiv sau negativ al dispozitivului de conectare PV. De asemenea, este interzisă atingerea ambilor poli simultan.
- Nu împământați polul pozitiv sau negativ al modulelor fotovoltaice (PV).
- Numai personalul calificat poate efectua cablarea panourilor fotovoltaice (PV).

AVERTIZARE!

Risc de rănire a personalului sau deteriorare a invertorului

- În timpul funcționării, nu atingeți alte părți, cu excepția comutatorului de c.c. și a panoului LCD.
- Nu conectați sau deconectați niciodată conectorii de c.a. și c.c. când invertorul funcționează.
- Opriti alimentarea c.a. și c.c. și deconectați-le de la invertor, așteptați 5 minute pentru a descărca complet tensiunea înainte de a încerca orice întreținere, curățare sau lucrare la orice circuit conectat.
- Asigurați-vă că tensiunea de intrare de c.c. \leq Tensiunea maximă de intrare c.c. a invertorului. Supratensiunea poate cauza deteriorarea permanentă a invertorului, care NU este acoperită de garanție.

ATENȚIE!

- Nu lăsați copiii în apropierea invertorului.
- Fiți atenți la greutatea invertorului. Dacă nu este manipulat corespunzător, pot fi cauzate vătămări personale.











NOTĂ!

- Dacă reglementările locale impun un RCD extern, verificați ce tip de RCD este necesar pentru codurile electrice relevante. Se recomandă utilizarea unui RCD tip A cu valoarea de 300 mA.
- Toate etichetele produselor și plăcuța de identificare de pe invertor trebuie să fie menținute vizibile clar.

Общи положения

- Съдържанието може да се обновява или ревизира периодично. SolaX си запазва правото да прави подобрения или промени в продукта (продуктите) и програмата (програмите), описани в това ръководство, без предизвестие.
- Монтажът, обслужването и свързването с електрическата мрежа следва да се извършват само от квалифицирани техници, които:
 - Притежават съответния лиценз и/или отговарят на държавните или общинските изисквания;
 - Познават добре това ръководство и свързаната документация.
- Преди монтажа на устройството трябва да прочетете внимателно, да разберете напълно и да спазвате стриктно подробните инструкции на ръководството за потребителя и свързаните разпоредби. SolaX не носи отговорност за никакви последици, причинени от неспазване на инструкциите за съхранение, транспортиране, монтаж и експлоатация, посочени в този документ и в ръководството за потребителя.
- Използвайте изолирани инструменти за монтажа на устройството. Носете лични предпазни средства по време на монтажа, електрическото свързване и обслужването.
- Посетете уеб сайта на SolaX www.solaxpower.com за повече информация.

Описание на стикерите

	CE маркировка за съответствие		TUV сертификация
	Внимание - риск от токов удар		Внимание - риск от опасност
	Прочетете приложената документация		Не изхвърляйте инвертора заедно с битовите отпадъци.
	Внимание - гореща повърхност		
	Допълнителна точка за заземяване		
	Не работете с инвертора, докато не бъде разединен от мрежата и от локалните PV системи.		
	Опасност от високо напрежение. Не докосвайте тоководещи части 5 минути след изключване на захранването.		

ОПАСНОСТ!

Смъртоносна опасност от токов удар

- Използвайте инвертора само когато е технически изправен. В противен случай има риск от токов удар или пожар.
- При никакви обстоятелства не отваряйте корпуса без разрешение от SolaX. Неоторизираното отваряне на корпуса ще анулира гаранцията и ще доведе до смъртоносна опасност или сериозна травма поради токов удар.

ОПАСНОСТ!

Смъртоносна опасност от токов удар при контакт с PV

- При излагане на слънчева светлина PV модулите генерират високо правотоково напрежение. Токвият удар ще доведе до смърт или смъртоносни травми.
- Никога не докосвайте положителния или отрицателния полюс на устройството за свързване към PV. Забранява се също двата полюса да се пипат едновременно.
- Не заземявайте положителния и отрицателния полюс на PV модулите.
- Само квалифицирани техници могат да работят по електрическата инсталация на PV панелите.

ПРЕДУПРЕЖДЕНИЕ!

Риск от физическа травма или повреда на инвертора

- По време на работа не пипайте никакви други части освен DC превключвателя и LCD панела.
- Никога не включвайте и не изключвайте AC и DC конекторите, докато инверторът работи.
- Изключете променливотоковото и правотоковото захранване, разкачете ги от инвертора и изчакайте 5 минути напрежението да изчезне напълно, преди да пристъпите към обслужване, почистване или друга работа по свързаните вериги.
- Уверете се, че входното правотоково напрежение е \leq на максималното правотоково входно напрежение на инвертора. Свърхнапрежението може да повреди трайно инвертора, а това НЕ се покрива от гаранцията.

ВНИМАНИЕ!

- Не допускайте деца в близост до инвертора.
- Имате предвид теглото на инвертора. Неправилната работа може да доведе до злополуки.

БЕЛЕЖКА!











- Ако местните разпоредби изискват да се използва външна ДТЗ, проверете какъв тип ДТЗ се изисква за съответните електрически кодове. Препоръчва се да се използва ДТЗ тип А със стойност 300 mA.
- Всички стикери и заводската табелка на инвертора трябва да се поддържат чисти.

Sikkerhed

Generel meddelelse

1. Indholdet kan blive opdateret eller revideret regelmæssigt. SolaX forbeholder sig retten til at foretage forbedringer eller ændringer i produktet/produkterne og programmerne beskrevet i denne manual uden forudgående varsel.
2. Installation, vedligeholdelse og netrelateret indstilling kan kun udføres af kvalificeret personale, som:
 - Er licenseret og/eller opfylder statslige og lokale jurisdiktionsregler
 - Har godt kendskab til denne manual og andre relaterede dokumenter.
3. Før du installerer enheden, skal du omhyggeligt læse, forstå og nøje følge den detaljerede vejledning i brugervejledningen og andre relaterede regler. SolaX hæfter ikke for eventuelle konsekvenser forårsaget af overtrædelse af opbevarings-, transport-, installations- og betjeningsreglerne specificeret i dette dokument og brugervejledningen.
4. Brug isoleret værktøj, når du installerer enheden. Individuelt beskyttelsesværktøj skal benyttes under installation, elektrisk tilslutning og vedligeholdelse.
5. Besøg venligst hjemmesiden www.solaxpower.com for SolaX for mere information.

Mærkatbeskrivelser

	CE-overensstemmelsesmærke		TÜV-certificering
	Forsigtig, risiko for elektrisk stød		Forsigtig, risiko for fare
	Læs den vedlagte dokumentation		Bortskaf ikke vekselretteren sammen med husholdningsaffald.
	Forsigtig, varm overflade		
	Ekstra jordingspunkt		
	Betjen ikke denne vekselretter, før den er isoleret fra lysnettet og PV-generende moduler på stedet.		
	Højspændingsfare Rør ikke ved spændingsførende dele i 5 minutter efter frakobling fra strømkilderne.		



FARE!

Livsfare på grund af elektrisk stød fra vekselretteren

- Vekselretteren må kun betjenes, når den er teknisk fejlfri. I modsat fald kan der opstå elektrisk stød eller brand.
- Kabinettet må under ingen omstændigheder åbnes uden forudgående godkendelse fra SolaX. Uautoriseret åbning vil ugyldiggøre garantien og forårsage livsfare eller alvorlig skade på grund af elektrisk stød.



FARE!

Livsfare på grund af elektrisk stød fra PV-modulet

- Når PV-moduler udsættes for sollys, genereres der høj jævnstrømsspænding. Elektrisk stød kan forårsage dødsfald eller livstruende kvæstelser.
- Rør aldrig ved den positive eller negative pol på PV-tilslutningsenheden. Det er også forbudt at berøre dem begge på samme tid.
- Forbind ikke den positive eller negative pol på PV-modulerne til jord.
- Kun kvalificeret personale kan udføre PV-panelernes ledningsføring.



ADVARSEL!

Risiko for personskade eller skade på vekselretteren

- Under drift må du ikke røre ved andre dele end jævnstrømsafbryderen (DC) og LCD-panelet.
- Tilslut eller frakobl aldrig vekselstrøms- (AC) og jævnstrømsstikkene (DC), når vekselretteren kører.
- Sluk for AC- og DC-strømmen, og afbryd dem fra vekselretteren, vent i 5 minutter for at aflade spændingen helt, før du forsøger at udføre vedligeholdelse, rengøring eller arbejde på tilsluttede kredsløb.
- Sørg for, at DC-indgangsspændingen \leq Maksimal DC-indgangsspænding for vekselretteren, Overspænding kan forårsage permanent skade på vekselretteren, hvilket IKKE er dækket af garantien.



FORSIGTIG!

- Hold børn væk fra vekselretteren.
- Vær opmærksom på vekselretterens vægt. Der kan opstå personskade, hvis den ikke håndteres korrekt.

BEMÆRK!











- Hvis en ekstern fejlstrømsafbryder er påkrævet i henhold til lokale regler, skal du kontrollere, hvilken type fejlstrømsafbryder, der kræves til relevante elforskrifter. Det anbefales at bruge en Type-A-fejlstrømsenhed med en værdi på 300 mA.
- Alle produktetiketter og navneskilt på vekselretteren skal altid være klart synlige.

Ασφάλεια

Γενικές ειδοποιήσεις

1. Τα περιεχόμενα μπορεί να ενημερώνονται ή να αναθεωρούνται περιοδικά. Η SolaX διατηρεί το δικαίωμα να προχωρήσει σε βελτιώσεις ή αλλαγές στο προϊόν(τα) και το πρόγραμμα(τα) που περιγράφονται σε αυτό το εγχειρίδιο χωρίς προηγούμενη ειδοποίηση.
2. Η εγκατάσταση, συντήρηση και η τοποθέτηση που σχετίζονται με το πλέγμα μπορούν να πραγματοποιηθούν μόνο από εξειδικευμένο προσωπικό που:
 - Διαθέτει άδεια και/ή πληροί τους κανονισμούς της πολιτείας και των τοπικών αρμόδιων.
 - Έχει καλή γνώση αυτού του εγχειριδίου και άλλων σχετικών εγγράφων.
3. Πριν από την εγκατάσταση της συσκευής, διαβάστε προσεκτικά, κατανοήστε πλήρως και τηρήστε πιστά τις σχετικές οδηγίες του εγχειριδίου χρήσης και άλλων σχετικών κανονισμών. Η SolaX δεν φέρει ευθύνη για οποιεσδήποτε συνέπειες προκαλούνται από παραβίαση των κανονισμών φύλαξης, μεταφοράς, εγκατάστασης και λειτουργίας που ορίζονται σε αυτό το έγγραφο και το εγχειρίδιο χρήσης.
4. Χρησιμοποιήστε μονωμένα εργαλεία κατά την εγκατάσταση της συσκευής. Τα ατομικά εργαλεία προστασίας πρέπει να φοριούνται κατά την εγκατάσταση, ηλεκτρική σύνδεση και συντήρηση.
5. Επισκεφθείτε τον ιστότοπο www.solaxpower.com της SolaX για περισσότερες πληροφορίες.

Περιγραφές ετικετών

	Σήμανση συμμόρφωσης CE		Πιστοποίηση TUV
	Προσοχή, πιθανότητα ηλεκτροπληξίας		Προσοχή, κίνδυνος
	Διαβάστε τα εσωκλειστα έγγραφα		Μην απορρίπτετε το inverter μαζί με τα οικιακά απορρίμματα.
	Προσοχή, καυτή επιφάνεια		
	Πρόσθετο σημείο γείωσης		
	Μην λειτουργείτε αυτό το inverter έως ότου απομονωθεί από το ρεύμα και από τους παρόχους παραγωγής PV στον χώρο.		
	Κίνδυνος υψηλής τάσης. Μην αγγίζετε τα ηλεκτροφόρα μέρη για 5 λεπτά μετά την αποσύνδεση από τις πηγές ρεύματος.		

ΚΙΝΔΥΝΟΣ!

Θανάσιμος κίνδυνος από ηλεκτροπληξία λόγω του inverter

- Χρησιμοποιείτε το inverter μόνο όταν δεν έχει τεχνικά σφάλματα. Διαφορετικά, υπάρχει πιθανότητα ηλεκτροπληξίας ή πυρκαγιάς.
- Μην ανοίγετε το κάλυμμα σε καμία περίπτωση χωρίς έγκριση από τη SolarX. Μη εξουσιοδοτημένο άνοιγμα θα ακυρώσει την εγγύηση και να προκαλέσει θανάσιμο κίνδυνο ή σοβαρό τραυματισμό λόγω ηλεκτροπληξίας.

ΚΙΝΔΥΝΟΣ!

Θανάσιμος κίνδυνος από ηλεκτροπληξία λόγω του PV

- Κατά την έκθεση σε ηλιακό φως, υψηλή τάση DC θα παραχθεί από τις μονάδες PV. Θάνατος ή θανάσιμοι τραυματισμοί λόγω ηλεκτροπληξίας.
- Ποτέ μην αγγίζετε τον θετικό ή αρνητικό πόλο της συσκευής σύνδεσης PV. Επίσης, απαγορεύεται το ταυτόχρονο άγγιγμα και των δύο πόλων.
- Μη γειώνετε τον θετικό ή αρνητικό πόλων των μονάδων PV.
- Μόνο εξειδικευμένο προσωπικό μπορεί να πραγματοποιήσει την καλωδίωση των πάνελ PV.

ΠΡΟΕΙΔΟΠΟΙΗΣΗ!

Κίνδυνος τραυματισμού προσωπικού ή βλάβη στο inverter

- Κατά τη λειτουργία, μην αγγίζετε κανένα μέρος εκτός από τον διακόπτη DC, το πάνελ LCD.
- Ποτέ μη συνδέετε ή αποσυνδέετε τις συνδέσεις AC και DC όταν το inverter λειτουργεί.
- Απενεργοποιήστε το ρεύμα AC και DC και αποσυνδέστε τα από το inverter, περιμένετε 5 λεπτά ώστε η τάση να αποφορτιστεί πλήρως πριν επιχειρήσετε οποιαδήποτε συντήρηση, καθαρισμό ή εργασία σε οποιοδήποτε συνδεδεμένο κύκλωμα.
- Βεβαιωθείτε ότι η τάση DC εισόδου \leq Μέγιστη τάση εισόδου DC του inverter. Η υπέρταση μπορεί να προκαλέσει μόνιμη βλάβη στο inverter, η οποία ΔΕΝ καλύπτεται από την εγγύηση.

ΠΡΟΣΟΧΗ!

- Κρατήστε τα παιδιά μακριά από το Inverter.
- Προσέξτε το βάρος του inverter. Υπάρχει πιθανότητα προσωπικών τραυματισμών σε περίπτωση εσφαλμένου χειρισμού.











ΕΙΔΟΠΟΙΗΣΗ!

- Εάν απαιτείται εξωτερικό RCD από τους τοπικούς κανονισμούς, ελέγξτε ποιος τύπος RCD απαιτείται για σχετικούς ηλεκτρικούς κωδικούς. Συνιστάται να χρησιμοποιείται Τύπος-A-RCD με την τιμή 300mA.
- Όλες οι ετικέτες προϊόντων και ταμπέλες επάνω στο Inverter θα παραμείνουν ξεκάθαρα ορατές.

Üldised märkused

1. Sisu võidakse perioodiliselt ajakohastada või läbi vaadata. SolaX jätab endale õiguse teha selles juhendis kirjeldatud tootes (toodetes) ja programmi(de)s parandusi või muudatusi ilma eelneva etteatamiseta.
2. Paigaldamist, hooldust ja võrguga seotud seadistamist võivad teha ainult kvalifitseeritud töötajad, kes:
 - on litsentseeritud ja/või vastavad riiklikele ja kohalikele õiguseeskirjadele;
 - tunnevad hästi käesolevat kasutusjuhendit ja muid sellega seotud dokumente.
3. Enne seadme paigaldamist lugege hoolikalt läbi, saage täielikult aru ja järgige rangelt kasutusjuhendi üksikasjalikke suuniseid ja muid seonduvaid eeskirju. SolaX ei vastuta tagajärgede eest, mis tulenevad käesolevas dokumendis ning kasutusjuhendis sätestatud ladustamis-, transpordi-, paigaldus- ja käitamismuudatustest.
4. Kasutage seadme paigaldamisel isoleeritud tööriistu. Paigaldamise, elektrilise ühendamise ja hoolduse ajal tuleb kanda isikukaitsevahendeid.
5. Lisateavet leiate SolaXi veebilehelt www.solaxpower.com.

Tähiste kirjeldused

	CE-vastavusmärk		TÜV sertifikaat
	Ettevaatust, elektrilöögi oht		Ettevaatust, oht
	Lugege lisatud dokumente		Ärge visake inverterit ära koos olmejäätmetega.
	Ettevaatust, kuum pind		
	Täiendav maanduspunkt		
	Ärge kasutage inverterit enne, kui see on isoleeritud vooluvõrgust ja kohapealsetest päikeseenergia tootjatest.		
	Kõrgepinge oht. Ärge puudutage pinget all olevaid osi 5 minuti jooksul pärast vooluvõrgust lahtiühendamist.		

**OHT!****Inverterist tulenev surmav elektrilöögi oht**

- Kasutage inverterit ainult siis, kui see on tehniliselt töökorras. Muidu võib tekkida elektrilöök või tulekahju.
- Ärge mingil juhul avage korpust ilma SolaXi loata. Ilma loata avamine muudab garantii kehtetuks ja põhjustab elektrilöögi tõttu surmaohtu või raskeid vigastusi.

**OHT!****Päikeseenergiast tingitud surmav elektrilöögi oht**

- Kui PV moodulid puutuvad kokku päikesevalgusega, tekib kõrge alalisvoolupinge. Elektrilöök võib põhjustada surma või surmavaid vigastusi.
- Ärge kunagi puudutage PV ühendusseadme positiivset või negatiivset poolust. Samuti on keelatud puudutada mõlemaid korruga.
- Ärge maandage PV moodulite positiivset või negatiivset poolust.
- PV paneelide juhtmistikuga võib töötada ainult kvalifitseeritud personal.

**HOIATUS!****Töötajate vigastuste või inverteri kahjustamise oht**

- Arge puudutage tootamise ajal muid osi peale alalisvoolu lüliti ja LCD-paneeli.
- Ärge kunagi ühendage ega lahutage vahelduv- ega alalisvooluühendusi inverteri töötamise ajal.
- Lülitage vahelduv- ja alalisvoolu toide välja ning ühendage need inverterist lahti, oodake 5 minutit, et pinge täielikult tühjeneks, enne kui püüate teha hooldustöid, puhastamist või tööd ühendatud vooluahelate kallal.
- Veenduge, et inverteri sisend-alalispinge \leq maksimaalne sisend-alalispinge. Ülepinge võib põhjustada inverterile püsivaid kahjustusi, mida garantii EI kata.

**HOIATUS!**

- Hoidke lapsed inverterist eemal.
- Pöörake tähelepanu inverteri kaalule. Nõuete eiramine võib põhjustada kehavigastusi.

TÄHELEPANU!











- Kui kohalikud eeskirjad nõuavad välist kaitselülilit, kontrollige, millist tüüpi kaitselülilit asjaomased elektrieskirjad nõuavad. Soovitatav on kasutada A-tüüpi kaitselülilit väärtusega 300 mA.
- Kõik inverteril olevad tootesildid ja nimesildid peavad olema selgelt nähtavad.

Turvallisuus

Yleinen ilmoitus

1. Sisältöä saatetaan päivittää tai muuttaa ajoittain. SolaX varaa oikeuden tehdä parannuksia ja muutoksia tässä oppaassa kuvattuihin tuotteisiin ja ohjelmiin ilman ennakoilmoitusta.
2. Asennus, huolto ja sähköverkkoon liittyvät asetukset on annettava sellaisen pätevän henkilöstön hoidettavaksi, joka täyttää seuraavat vaatimukset:
 - on lisensoitu ja/tai täyttää osavaltion ja paikallisen lainsäädännön vaatimukset
 - tuntee tämän oppaan ja muut aiheeseen liittyvät asiakirjat hyvin
3. Ennen kuin asennat laitteen, lue käyttöohjeen yksityiskohtaiset ohjeet ja muut aiheeseen liittyvät säännökset huolella, ymmärrä ne täysin ja noudata niitä tarkkaan. SolaX ei ole vastuussa mistään seuraamuksista, jotka johtuvat tämän asiakirjan ja käyttöoppaan säilytys-, kuljetus-, asennus- ja käyttöohjeiden rikkomisesta.
4. Käytä laitetta asentaessasi eristettyjä työkaluja. Asennuksen, sähkökytkentöjen ja huollon aikana on käytettävä henkilökohtaisia suojaavia työkaluja.
5. Lisätietoja on SolaXin sivustolla www.solaxpower.com.

Kylttien kuvaukset

	CE-vaatimustenmukaisuusmerkki		TUV-sertifikaatti
	Huomio, sähköiskun vaara		Huomio, vaaran mahdollisuus
	Lue mukana tulevat asiakirjat		Älä hävitä invertterinä kotitalousjätteen mukana.
	Varoitus, kuuma pinta		
	Ylimääräiset maadoituskohdat		
	Älä käytä tätä invertterinä, ennen kuin se on eristetty verkkovirrasta ja paikan päällä sijaitsevista aurinkosähkötoimittajista.		
	Suurjännitteen vaara. Älä kosketa sähköistettyjä osia 5 minuuttiin laitteen irrottamisesta virtalähteestä.		

 **VAARA!**

Hengenvaara invertteristä aiheutuvan sähköiskun vaaran takia

- Käytä invertteriä vain, kun se on teknisesti moitteeton. Muutoin seurauksena voi olla sähköisku tai tulipalo.
- Älä avaa koteloa missään tapauksessa ilman SolaX:n lupaa. Luvaton avaaminen mitätöi takuun ja voi aiheuttaa hengenvaaran tai vakavan vamman sähköiskun takia.

 **VAARA!**

Hengenvaara PV:stä aiheutuvan sähköiskun vaaran takia

- Auringon valolle altistuessaan PV-moduuleissa syntyy korkea tasajännite. Sähköisku aiheuttaa kuoleman tai hengenvaarallisen vamman.
- Älä koskaan kosketa PV-liitäntälaitteen positiivista tai negatiivista napaa. Molempien koskettaminen yhtä aikaa on myös kielletty.
- Älä maadoita PV-moduulien positiivista tai negatiivista napaa.
- Vain pätevä henkilöstö voi kytkeä PV-paneelit.

 **VAROITUS!**

Loukkaantumisen tai invertterin vahingoittumisen vaara

- Älä kosketa käytön aikana mitään muita osia kuin DC-kytkintä ja LCD-paneelia.
- Älä koskaan kytke tai irrota AC- ja DC-liittimiä invertterin ollessa käynnissä.
- Kytke AC- ja DC-virta pois päältä ja irrota ne invertteristä ja odota 5 minuuttia, jotta jännite purkautuu täysin, ennen kuin yrität huoltaa, puhdistaa tai käsitellä mitään kytkettyjä piirejä.
- Varmista, että tulotasajännite \leq invertterin suurin tulotasajännite. Ylijännite voi aiheuttaa invertterille pysyviä vaurioita, joita takuu EI kata.

 **HUOMIO!**

- Pidä lapset kaukana invertteristä.
- Huomioi invertterin paino. Virheellisestä käsittelystä voi seurata loukkaantumisia.











HUOMAUTUS!

- Jos paikalliset määräykset edellyttävät ulkoista vikavirtasuojaa, tarkista, minkä tyyppinen vikavirtasuojaa asianmukaisissa sähkösäännöksissä vaaditaan. Suosittelemme käyttämään A-tyyppin 300 mA:n vikavirtasuojaa.
- Kaikki invertterin tuotemerkinnät ja nimikilpi on pidettävä selkeästi näkyvillä.

Opća obavijest

- Sadržaj se može povremeno ažurirati ili mijenjati. Tvrtka SolaX zadržava pravo izvršiti poboljšanja ili izmjene na proizvodima i programima opisanim u ovom priručniku bez prethodne obavijesti.
- Ugradnju, održavanje i postavljanje u vezi s mrežom smije vršiti samo kvalificirano osoblje koje:
 - ima licencu i/ili udovoljava propisima u državnoj i lokalnoj nadležnosti;
 - dobro poznaje ovaj priručnik i druge povezane dokumente.
- Prije ugradnje uređaja pažljivo pročitajte, u potpunosti usvojite i strogo slijedite detaljne upute korisničkog priručnika i druge povezane propise. Tvrtka SolaX nije odgovorna ni za koje posljedice prouzročene kršenjem propisa o skladištenju, prijevozu, ugradnji i rukovanju koji su navedeni u ovom dokumentu i korisničkom priručniku.
- Pri ugradnji uređaja upotrebljavajte izolirane alate. Obvezno je nošenje osobne zaštitne opreme pri ugradnji, priključivanju električne energije i održavanju.
- Za više informacija posjetite web-mjesto tvrtke SolaX: www.solaxpower.com.

Opisi oznaka

	Oznaka sukladnosti CE		Certifikacija TUV
	Oprez, rizik od strujnog udara		Oprez, rizik od opasnosti
	Pročitajte priloženu dokumentaciju		Ne odlažite izmjenjivač zajedno s kućanskim otpadom.
	Oprez, vruća površina		
	Dodatno mjesto uzemljenja		
	Ne rukujte ovim izmjenjivačem sve dok ne bude izoliran s mrežnog napajanja i dovoda fotonaponske energije na lokaciji.		
	Opasnost od visokog napona. Ne dodirujte dijelove pod naponom 5 minuta nakon isključivanja s izvora energije.		

OPASNOST!

Smrtonosna opasnost od strujnog udara pri uporabi izmjenjivača

- Rukujte izmjenjivačem samo kada je potpuno tehnički ispravan. U suprotnom može doći do strujnog udara ili požara.
- Ni u kojem slučaju ne otvarajte kućište bez odobrenja tvrtke SolaX. Neovlašteno otvaranje poništava jamstvo te može prouzročiti smrtonosnu opasnost ili tešku ozljedu uslijed strujnog udara.

OPASNOST!

Smrtonosna opasnost od strujnog udara pri uporabi fotonaponske energije

- Kada su izloženi sunčevoj svjetlosti, fotonaponski moduli proizvode će istosmjernu struju visokog napona. Uslijed strujnog udara doći će do smrti ili smrtonosnih ozljeda.
- Nikada ne dodirujte pozitivni ili negativni pol uređaja za fotonaponski priključak. Zabranjeno je i istovremeno dodirivanje oba pola.
- Nemojte uzemljivati pozitivni ili negativni pol fotonaponskih modula.
- Ožičavanje fotonaponskih ploča može provoditi samo kvalificirano osoblje.

UPOZORENJE!

Rizik od ozljeđivanja osoblja ili oštećenja izmjenjivača

- Tijekom rada nemojte dodirivati nijedan dio izmjenjivača osim prekidača istosmjerne struje i LCD ploče.
- Nikada nemojte uključivati ili isključivati priključke izmjenične i istosmjerne struje dok izmjenjivač radi.
- Prije početka svakog održavanja, čišćenja ili rada na bilo kojem priključenom strujnom krugu, isključite izmjenično i istosmjerno napajanje i isključite ih s izmjenjivača te pričekajte 5 minuta kako bi se napon potpuno ispraznio.
- Vodite računa da je ulazni napon istosmjerne struje \leq maksimalnim ulaznim naponom istosmjerne struje na izmjenjivaču. Prenapon može prouzročiti trajno oštećenje izmjenjivača, a ono NIJE obuhvaćeno jamstvom.

OPREZI!

- Držite djecu podalje od izmjenjivača.
- Obratite pozornost na težinu izmjenjivača. Ako se njime ne rukuje ispravno, može doći do tjelesnih ozljeda.











OBAVIJEST!

- Ako lokalni propisi zahtijevaju vanjski RCD, provjerite koji tip RCD-a je potreban za odgovarajuće električne značajke. Preporučuje se koristiti se RCD-om tipa A s vrijednošću od 300 mA.
- Sve oznake proizvoda i natpisna pločica izmjenjivača moraju biti jasno vidljive.

Általános tájékoztató

1. A tájékoztató tartalma időről időre frissülhet vagy átdolgozásra kerülhet. A SolaX fenntartja a jogot az ebben a kézikönyvben ismertetett termék(ek) és a program(ok) előzetes értesítés nélkül történő javítására.
2. A telepítést, karbantartást és a hálózattal kapcsolatos beállításokat kizárólag olyan képesített személyzet végezheti, amely:
 - az állami és helyi engedéllyel rendelkezik és/vagy jogszabályok előírásainak megfelelnek;
 - ezt a kézikönyvet és az egyéb kapcsolódó dokumentumokat jól ismerik.
3. A készülék telepítése előtt gondosan olvassa el, értelmezze teljes mértékben és szigorúan kövesse a felhasználói kézikönyv és egyéb kapcsolódó szabályozások részletes utasításait. A SolaX nem köteles helytállni az ebben a dokumentumban és a felhasználói kézikönyvben meghatározott tárolási, szállítási, telepítési és üzemeltetési szabályok megszegésével okozott semmilyen következményért.
4. A készülék telepítése során szigetelt szerszámokat használjon. A telepítés, az elektromos bekötés és a karbantartás elvégzése során kötelező egyéni védőeszközt viselni.
5. Bővebb tájékoztatásért keresse fel a SolaX honlapját a www.solaxpower.com címen.

Címkék ismertetése

	CE megfelelési jelzés		TÜV tanúsítvány
	Vigyázat, áramütés veszélye		Vigyázat, veszély kockázata
	Olvassa el a mellékelt dokumentációkat		Az invertert ne háztartási hulladékkal ártalmatlanítsa.
	Vigyázat, forró felület		
	További földelési pont		
	Az invertert csak akkor üzemeltesse, ha már elszigetelte a fő áramellátástól és a telephelyi PV generátoroktól.		
	Nagyfeszültség veszélye.		
	Az áramellátásról való leválasztást követően 5 percig ne érjen az élesüzemi részekhez.		

! VESZÉLY!**Az inverter miatt a halálos áramütés veszélye áll fenn**

- Az invertert kizárólag akkor üzemeltesse, ha műszakilag hibátlan. Egyébként áramütésre vagy tüzre kerülhet sor.
- A nyílást a SolaX engedélye nélkül semmilyen esetben ne nyissa ki. Az engedély nélküli nyitás a jótállás érvénytelenségét eredményezi, és áramütés miatt halálos veszélyt vagy súlyos sérülést okozhat.

! VESZÉLY!**A PV miatt a halálos áramütés veszélye áll fenn**

- Napfénynek kitéve a PV modulok nagy egyenáramú feszültséget generálnak. Áramütés miatt halál vagy halálos sérülés következhet be.
- A PV csatlakoztató eszköz pozitív vagy negatív pólusát soha ne érintse meg. Ugyancsak tilos egyszerre megérinteni a kettőt.
- Ne földelje a PV modulok pozitív vagy negatív pólusát.
- A PV panelek vezetékvezetését kizárólag képzett személy végezheti.

! VIGYÁZAT!**Személyi sérülés vagy az inverter károsodásának kockázata**

- Üzemelés során kizárólag az inverter DC csatlakozójához és LDC paneléhez érhet hozzá.
- Az inverter üzemelése közben soha ne csatlakoztassa vagy válassa le a váltóáramú és egyenáramú csatlakozókat.
- Kapcsolja ki a váltó- és egyenáramú tápellátást és válassa le az inverterről, várjon 5 percet a feszültség teljes kikapcsolásáig, és csak ezt követően próbálja meg a karbantartási, tisztítási vagy bármely csatlakozó áramkörön végzendő munkát megkezdeni.
- Győződjön meg róla, hogy a bemenő egyenáramú feszültség legalább egyenlő az inverter maximális egyenáramú bemenő feszültségével. A túlfeszültség az inverter tartós károsodását okozhatja, amelyre a jótállás NEM vonatkozik.

! VIGYÁZAT!

- A gyermekeket tartsa távol az invertertől.
- Figyelje az inverter súlyát. A nem megfelelő kezelés személyi sérülést okozhat.











FIGYELEM!

- Ha a helyi szabályozások külső érintésvédelmi relé alkalmazását írják elő, ellenőrizze, milyen típusú érintésvédelmi berendezésre van szükség a vonatkozó elektromos szabályozások szerint. Javasolt 300 mA értékű A típusú érintésvédelmi relét alkalmazni.
- Az inverter összes termékcímkéjét és adattábláját mindig jól láthatóan kell karbantartani.

Bendroji pastaba

1. Turinys gali būti periodiškai atnaujinamas arba peržiūrimas. „SolaX“ pasilieka teisę tobulinti ar keisti šiame vadove aprašytą (-us) produktą (-us) ir programą (-as) be išankstinio įspėjimo.
2. Montavimo, techninės priežiūros ir su tinklu susijusius paruošimo darbus gali atlikti tik kvalifikuoti darbuotojai, kurie:
 - turi licenciją ir (arba) atitinka valstybės ir vietos jurisdikcijos taisykles;
 - gerai išmano šį vadovą ir kitus susijusius dokumentus.
3. Prieš montuodami įrenginį atidžiai perskaitykite, visiškai supraskite ir griežtai laikykitės išsamių naudotojo vadovo ir kitų susijusių taisyklių nurodymų. „SolaX“ neatsako už jokiais pasekmės, atsiradusias dėl šiame dokumente ir naudotojo vadove nurodytų laikymo, transportavimo, montavimo ir naudojimo taisyklių nesilaikymo.
4. Montuodami prietaisą naudokite izoliuotus įrankius. Montuojant, prijungiant prie elektros tinklo ir atliekant techninę priežiūrą būtina dėvėti individualias apsaugos priemones.
5. Daugiau informacijos rasite „SolaX“ svetainėje www.solaxpower.com.

Užrašų aprašymai

	CE atitikties ženklas		TUV sertifikavimas
	Atsargiai, elektros smūgio pavojus		Atsargiai, pavojinga
	Perskaitykite pridedamus dokumentus		Neišmeskite inverterio su buitinėmis atliekomis.
	Atsargiai, karštas paviršius		
	Papildomas įžeminimo kontaktas		
	Nenaudokite šio inverterio, kol jis nebus atjungtas nuo elektros tinklo ir vietoje veikiančių fotovoltinės energijos gamybos tiekėjų.		
	Aukštos įtampos pavojus. 5 minutes po atjungimo nuo maitinimo šaltinių nelieskite įtampą turinčių dalių.		

⚠ PAVOJUS!**Mirtinas elektros smūgio pavojus dėl inverterio**

- Inverterį naudokite tik tada, kai jis yra techniškai tvarkingas. Priešingu atveju gali ištikti elektros smūgis arba kilti gaisras.
- Jokiu būdu neatidarykite korpuso be „SolaX“ leidimo. Atidarymas be leidimo panaikins garantijos galiojimą ir sukels mirtiną pavojų arba rimtus sužalojimus dėl elektros smūgio.

⚠ PAVOJUS!**Mirtinas elektros smūgio pavojus dėl fotovoltinės energijos**

- Saulės šviesoje fotovoltiniai moduliai generuoja aukštą nuolatinę įtampą. Dėl elektros smūgio gali ištikti mirtis arba galima patirti mirtinus sužalojimus.
- Niekada nelieskite fotovoltinio jungiamojo įrenginio teigiamo arba neigiamo poliaus. Taip pat draudžiama liesti juos abu vienu metu.
- Nežeminkite fotovoltinių teigiamo arba neigiamo poliaus.
- Fotovoltinių skydų elektros instaliaciją gali įrengti tik kvalifikuoti darbuotojai.

⚠ ĮSPĖJIMAS!**Personalo sužeidimo arba inverterio pažeidimo rizika**

- Naudodami nelieskite jokių kitų dalių, išskyrus nuolatinės srovės (DC) jungiklį ir skystųjų kristalų skydelį.
- Niekada nejunkite ir neatjunkite kintamosios ir nuolatinės srovės jungčių, kai veikia inverteris.
- Išjunkite kintamosios (AC) ir nuolatinės srovės (DC) maitinimus ir atjunkite juos nuo inverterio; tuomet palaukite 5 minutes, kad įtampa visiškai nukristų, prieš atlikdami bet kokius techninės priežiūros darbus, valydami ar dirbdami su bet kokiomis prijungtomis grandinėmis.
- Įsitinkinkite, kad nuolatinės srovės (DC) jėgimo įtampa \leq už maksimalią inverterio nuolatinės srovės (DC) jėgimo įtampą. Viršįtampis gali sukelti nuolatinę žalą inverteriui; tokiu atveju garantija NĖRA taikoma.

⚠ DĖMESIO!

- Neleiskite vaikams būti prie inverterio.
- Atkreipkite dėmesį į inverterio svorį. Netinkamai elgiantis gali būti sužaloti žmonės.











PASTABA!

- Jei pagal vietines taisykles reikalaujama naudoti išorinę srovės nuotėkio relę (RCD), patikrinkite, kokio tipo srovės nuotėkio relė reikalaujama pagal atitinkamas elektros taisykles. Rekomenduojama naudoti A tipo srovės nuotėkio relę, kurios vardinė srovė yra 300 mA.
- Visi ant inverterio esantys produkto užrašai ir vardinė lentelė turi būti gerai matomi.

Vispārīgs paziņojums

1. Saturs periodiski var tikt atjaunots vai pārskatīts. SolaX patur tiesības bez iepriekšēja brīdinājuma veikt šajā rokasgrāmatā aprakstītā(-o) izstrādājuma(-u) un programmas(-u) uzlabojumus un izmaiņas.
2. Uzstādīšanu, apkopi un ar tīklu saistītos iestatījumus var veikt tikai kvalificēts personāls, kas atbilst šādām prasībām:
 - ir licencēts un/vai atbilst valsts un vietējo tiesību aktu noteikumiem;
 - labi pārzina šo rokasgrāmatu un citus saistītos dokumentus.
3. Pirms ierīces uzstādīšanas rūpīgi izlasiet, pilnīgi izprotiet un stingri ievērojiet lietotāja rokasgrāmatā un citos saistītajos noteikumos sniegtos norādījumus. SolaX neuzņemas atbildību ne par kādām sekām, ko izraisījuši šajā dokumentā un lietotāja rokasgrāmatā noteikto glabāšanas, transportēšanas, uzstādīšanas un ekspluatācijas noteikumu pārkāpumi.
4. Uzstādot šo ierīci, izmantojiet izolētus darbarīkus. Uzstādot, pievienojot elektrībai un veicot apkopi, jāvalkā individuālie aizsarglīdzekļi.
5. Lūdzu, apmeklējiet SolaX tīmekļa vietni www.solaxpower.com, lai saņemtu sīkāku informāciju.

Etīķešu apraksts

	CE atbilstības zīme		TUV sertifikācija
	Uzmanību, elektriskās strāvas trieciena risks		Uzmanību, bīstamības risks
	Izlasiet pievienotos dokumentus		Neizmetiet invertoru kopā ar sadzīves atkritumiem.
	Uzmanību, karsta virsma		
	Papildu zemējuma punkts		
	Neizmantojiet šo invertoru, ja tas nav izolēts no elektrotīkla un vietējiem saules paneļu ģeneratoriem.		
	Augsta sprieguma radīts apdraudējums. Nepieskarieties strāvu vadošajām daļām 5 minūtes pēc atvienošanas no strāvas avotiem.		

 **BĪSTAMI!**

Bojāejas risks invertora radīta elektriskās strāvas trieciena dēļ.

- Eksploatējiet invertoru tikai tad, ja tam nav nekādu tehnisku defektu. Pretējā gadījumā var notikt elektriskās strāvas trieciens.
- Nekādā gadījumā neatveriet korpusu bez SolaX atļaujas. Neatļauta atvēršana anulē garantiju un rada bojāejas vai smagu traumu risku elektriskās strāvas trieciena dēļ.

 **BĪSTAMI!**

Bojāejas risks saules paneļa radīta elektriskās strāvas trieciena dēļ.

- Saules paneļu moduļi ģenerē lielu līdzstrāvas spriegumu, kad uz tiem iedarbojas saules gaisma. Elektriskās strāvas trieciens var izraisīt nāvi vai nāvējošus ievainojumus.
- Nekādā gadījumā nepieskarieties saules paneļu savienojuma ierīces pozitīvajam vai negatīvajam polam. Aizliegts ir arī pieskarties abiem poliem vienlaikus.
- Neieņemiet saules paneļu moduļu pozitīvo vai negatīvo polu.
- Saules paneļu elektroinstalāciju drīkst veikt tikai kvalificēts personāls.

 **BRĪDINĀJUMS!**

Fizisku ievainojumu vai invertora bojājuma risks

- Eksploatācijas laikā nepieskarieties nekādām citām invertora daļām, izņemot līdzstrāvas slēdzi un LCD paneli.
- Nekad nepievienojiet un neatvienojiet maiņstrāvas un līdzstrāvas kontaktus, kad invertors darbojas.
- Pirms jebkādu apkopes vai tīrīšanas darbu veikšanas vai arī darba pie jebkuriem pieslēgtajiem kontūriem izslēdziet maiņstrāvas un līdzstrāvas barošanu, atvienojiet to no invertora un pēc tam nogaidiet 5 minūtes, lai spriegums pilnībā izlādētos.
- Pārliecinieties, ka ieejas līdzstrāvas spriegums ir mazāks par vai vienāds ar invertora maksimālo ieejas spriegumu. Pārspriegums var izraisīt neatgriezeniskus invertora bojājumus, ko NESEDZ garantija.

 **UZMANĪBU!**

- Sargājiet invertoru no bērniem.
- Pievērsiet uzmanību invertora svaram. Rīkojoties neuzmanīgi, var gūt traumas.











IEVĒROJIET!

- Ja vietējie noteikumi paredz, ka nepieciešama paliekošās strāvas aizsargierīce (RCD), pārbaudiet, kāda veida RCD ierīce nepieciešama attiecīgajiem elektriskajiem kodiem. Ieteicams izmantot A tipa aizsargierīci ar 300 mA nominālu.
- Visām izstrādājuma etiķetēm un nosaukuma plāksnītei uz invertora jābūt skaidri salasāmām.

Všeobecné upozornenia

1. Obsah dokumentu môže byť pravidelne aktualizovaný alebo revidovaný. Spoločnosť SolaX si vyhradzuje právo na akékoľvek zlepšenia a zmeny produktu (produktov) a programu (programov) popísaných v tomto návode bez predchádzajúceho upozornenia.
2. Inštaláciu, údržbu a nastavenie súvisiace so sieťou môže vykonávať len kvalifikovaný personál, ktorý:
 - má licenciu a/alebo spĺňa štátne a miestne právne predpisy,
 - je podrobne oboznámený s týmto návodom a ďalšími súvisiacimi dokumentmi.
3. Pred inštaláciou zariadenia si pozorne prečítajte, plne pochopte a striktno dodržiavajte podrobné pokyny v návode na obsluhu a ďalšie súvisiace predpisy. Spoločnosť SolaX nezodpovedá za žiadne následky spôsobené porušením predpisov týkajúcich sa skladovania, prepravy, inštalácie a prevádzky, ktoré sú uvedené v tomto dokumente a návode na obsluhu.
4. Pri inštalácii zariadenia používajte izolované nástroje. Pri inštalácii, elektrickom zapojení a údržbe je nutné používať osobné ochranné pomôcky.
5. Viac informácií nájdete na webovej stránke spoločnosti SolaX www.solaxpower.com.

Popis štítkov

	CE označenie zhody		TUV certifikácia
	Pozor, nebezpečenstvo úrazu elektrickým prúdom		Pozor, riziko nebezpečenstva
	Prečítajte si priložené dokumenty		Nelikvidujte invertor spolu s komunálnym odpadom.
	Pozor, horúci povrch		
	Dodatočný uzemňovací bod		
	Nepracujte na tomto invertore, kým nie je odpojený od hlavnej rozvodnej siete a lokálnych modulov na výrobu fotovoltaickej energie.		
	Nebezpečenstvo vysokého napätia. Nedotýkajte sa častí pod napätím po dobu 5 minút po odpojení od zdroja napájania.		

⚠ NEBEZPEČENSTVO!**Smrteľné nebezpečenstvo úrazu elektrickým prúdom spôsobené invertorom**

- Invertor uvádzajte do prevádzky len vtedy, ak je technicky bezchybný. V opačnom prípade môže dôjsť k úrazu elektrickým prúdom alebo požiaru.
- V žiadnom prípade neotvárajte kryt bez povolenia od spoločnosti SolaX. Neoprávnené otvorenie bude mať za následok stratu záruky a spôsobí smrteľné nebezpečenstvo alebo vážne zranenie v dôsledku úrazu elektrickým prúdom.

⚠ NEBEZPEČENSTVO!**Smrteľné nebezpečenstvo úrazu elektrickým prúdom spôsobené fotovoltaikou**

- Pri vystavení slnečnému zariadeniu budú fotovoltaické moduly generovať vysoké jednosmerné napätie. V dôsledku zásahu elektrickým prúdom môže dôjsť k usmrteniu alebo smrteľnému zraneniu.
- Nikdy sa nedotýkajte kladného alebo záporného pólu fotovoltaického spojovacieho zariadenia. Dotýkať sa oboch naraz je tiež zakázané.
- Neuzemňujte kladný ani záporný pól fotovoltaických modulov.
- Zapojenie fotovoltaických panelov môže vykonávať len kvalifikovaný personál.

⚠ VAROVANIE!**Nebezpečenstvo poranenia osôb alebo poškodenia invertora**

- Počas prevádzky sa nedotýkajte žiadnych častí okrem spínača jednosmerneho prúdu a LCD panela.
- Keď je invertor v prevádzke, nikdy nepripájajte ani neodpájajte konektory jednosmerneho a striedavého prúdu.
- Vypnite napájanie striedavým a jednosmerným prúdom a odpojte od nich invertor. Predtým, než pristúpite k údržbe, čisteniu alebo práci na akýchkoľvek pripojených obvodoch, počkajte 5 minút, kým sa napätie úplne vybije.
- Uistite sa, že vstupné jednosmerné napätie \leq maximálne jednosmerné vstupné napätie invertora. Prepätie môže spôsobiť trvalé poškodenie invertora, na ktoré sa NEVŽŤAHUJE záruka.

⚠ POZOR!

- Uchovávajte invertor mimo dosahu detí.
- Venujte pozornosť hmotnosti invertora. Pri nesprávnom zaobchádzaní môže dôjsť k zraneniu osôb.











UPOZORNENIE!

- Ak miestne predpisy vyžadujú inštaláciu externého prúdového chrániča, overte, ktorý typ prúdového chrániča sa vyžaduje pre príslušné elektrické kódy. Odporúča sa použiť prúdový chránič typu A s citlivosťou 300 mA.
- Všetky produktové štítky a typový štítok na invertore musia byť udržiavané tak, aby boli dobre viditeľné.

Splošno obvestilo

1. Vsebina se lahko občasno posodablja ali revidira. SolaX si pridržuje pravico do izboljšav ali sprememb v izdelkih in programih, opisanih v tem priročniku, brez predhodnega obvestila.
2. Namestitev, vzdrževanje in nastavitev, povezano z omrežjem, lahko izvaja samo usposobljeno osebje, ki:
 - ima licenco in/ali izpolnjuje državne in lokalne predpise;
 - dobro pozna ta priročnik in druge povezane dokumente.
3. Pred namestitvijo naprave natančno preberite, v celoti razumite in dosledno upoštevajte podrobna navodila uporabniškega priročnika in druge s tem povezane predpise. SolaX ne prevzema odgovornosti za posledice, ki nastanejo zaradi kršitve predpisov o shranjevanju, transportu, namestitvi in delovanju, navedenih v tem dokumentu in uporabniškem priročniku.
4. Pri nameščanju naprave uporabljajte izolirana orodja. Med namestitvijo, električnim priklopom in vzdrževanjem je treba nositi osebna zaščitna orodja.
5. Za več informacij obiščite spletno stran www.solaxpower.com podjetja SolaX.

Opisi nalepk

	Oznaka skladnosti CE		TUV certifikat
	Pozor, nevarnost električnega udara		Pozor, možna nevarnost
	Preberite priloženo dokumentacijo		Razsmernika ne odlagajte skupaj z gospodinjstvi odpadki.
	Pozor, vroča površina		
	Dodatna ozemljitvena točka		
	Ne uporabljajte tega razsmernika, dokler ni izoliran od električnega omrežja in dobaviteljev fotonapetostne proizvodnje na kraju samem.		
	Nevarnost visoke napetosti. Ne dotikajte se delov pod napetostjo 5 minut po odklopu iz virov napajanja.		

⚠ NEVARNOST!**Smrtna nevarnost zaradi električnega udara zaradi razsmernika**

- Razsmernik uporabljajte le, če je tehnično brezhiben. V nasprotnem primeru lahko pride do električnega udara ali požara.
- V nobenem primeru ne odpirajte ohišja brez dovoljenja družbe SolaX. Nepooblaščenno odpiranje bo razveljavilo garancijo in povzročilo smrtno nevarnost ali resne poškodbe zaradi električnega udara.

⚠ NEVARNOST!**Smrtna nevarnost zaradi električnega udara zaradi fotonapetosti**

- Ko so izpostavljeni sončni svetlobi, bodo fotonapetostni moduli ustvarili visoko enosmerno napetost. Zaradi električnega udara lahko pride do smrti ali smrtnih poškodb.
- Nikoli se ne dotikajte pozitivnega ali negativnega pola fotonapetostne priključne naprave. Prepovedano je tudi dotikanje obeh hkrati.
- Ne ozemljite pozitivnega ali negativnega pola fotonapetostnih modulov.
- Ožičenje fotonapetostnih panelov lahko izvaja samo usposobljeno osebje.

⚠ OPOZORILO!**Nevarnost telesnih poškodb ali poškodb razsmernika**

- Med delovanjem se ne dotikajte nobenih delov razen stikala DC, LCD plošče.
- Nikoli ne priklaplajte ali odklaplajte priključkov AC in DC, ko razsmernik deluje.
- Izklopite napajanje izmeničnega in enosmernega toka in ju odklopite iz razsmernika, počakajte 5 minut, da se napetost popolnoma izprazni, preden poskusite vzdrževati, čistiti ali delati na katerem koli priključenem tokokrogu.
- Prepričajte se, da je vhodna enosmerna napetost \leq največja enosmerna vhodna napetost razsmernika. Previsoka napetost lahko povzroči trajno škodo na razsmerniku, česar garancija NE pokriva.

⚠ POZOR!

- Otroci naj se ne približujejo razsmerniku.
- Bodite pozorni na težo razsmernika. Če z njim ne ravnate pravilno, lahko pride do telesnih poškodb.











OBVEŠTILO!

- Če lokalni predpisi zahtevajo zunanji RCD, preverite, kateri tip RCD je zahtevan za ustrezne električne kode. Priporočljivo je, da uporabite RCD tipa A z vrednostjo 300 mA.
- Vse oznake izdelkov in tablica z imenom na pretvorniku morajo biti jasno vidni na razsmerniku.

Genel Bildirim

1. İçindekiler periyodik olarak güncellenebilir veya revize edilebilir. SolaX, önceden haber vermeksizin ürün(ler) ve bu kılavuzda açıklanan program(lar) üzerinde iyileştirme veya değişiklik yapma hakkını saklı tutar.
2. Kurulum, bakım ve şebekeyle ilgili ayar sadece aşağıdaki özelliklere sahip kalifiye personel tarafından gerçekleştirilebilir:
 - Ulusal ve yerel yasal yetki bölgelerinde lisanslı olmalı ve buralardaki düzenlemelerle uyumlu olmalıdır;
 - Bu kılavuz ve diğer ilgili dokümanlar hakkında iyi bilgiye sahip olmalıdır.
3. Cihazı kurmadan önce kullanım kılavuzunun ve diğer ilgili düzenlemelerin ayrıntılı talimatlarını dikkatlice okuyun, tam olarak anlayın ve kesinlikle uygulayın. SolaX, bu dokümanda ve kullanım kılavuzunda belirtilen depolama, taşıma, kurulum ve işletme düzenlemelerinin ihhalinden kaynaklanan sonuçlardan sorumlu olmayacaktır.
4. Cihazı kurarken yalıtımlı aletler kullanın. Kurulum, elektrik bağlantısı ve bakım sırasında bireysel koruyucu aletler takılmalıdır.
5. Daha fazla bilgi için lütfen www.solaxpower.com of SolaX web sitesini ziyaret edin.

Etiketlerin Açıklamaları

	CE uygunluk işareti		TUV uygunluk işareti
	Dikkat, elektrik çarpması riski		Dikkat, tehlike riski
	Ekteki dokümanları okuyun		İnvertörü evsel atıklarla birlikte atmayın.
	Dikkat, sıcak yüzey		
	Ek topraklama noktası		
	Şebeke ve yerinde PV üretimi besleyicilerinden izole edilene kadar bu invertörü çalıştırmayın.		
	Yüksek gerilim tehlikesi. Güç kaynaklarından ayrıldıktan sonra yüklü parçalara 5 dakika boyunca dokunmayın.		

TEHLİKE!

İnvertör nedeniyle elektrik çarpması kaynaklı ölümcül tehlike

- İnvertörü yalnızca teknik olarak hatasız olduğunda çalıştırın. Aksi takdirde elektrik çarpması veya yangın meydana gelebilir.
- Muhafazayı hiçbir durumda SolaX'in izni olmadan açmayın. Yetkisiz açılma garantisi geçersizdir ve elektrik çarpması nedeniyle ölümcül tehlikeye veya ciddi yaralanmalara neden olur.

TEHLİKE!

PV nedeniyle elektrik çarpması kaynaklı ölümcül tehlike

- Güneş ışığına maruz kaldığında PV modülleri tarafından yüksek DC gerilim üretilir. Elektrik çarpması nedeniyle ölüm veya ölümcül yaralanmalar meydana gelebilir.
- PV bağlantı cihazının pozitif veya negatif kutbuna asla dokunmayın. İkisine de aynı anda dokunmak da yasaktır.
- PV modüllerinin pozitif veya negatif kutbunu topraklamayın.
- PV panellerinin kablolarını yalnızca kalifiye personel bağlayabilir.

UYARI!

Personel yaralanması veya invertör hasarı riski

- Çalışma sırasında DC anahtarı ve LCD panel dışındaki herhangi bir parçaya dokunmayın.
- İnvertör çalışırken AC ve DC konnektörlerini asla bağlamayın veya çıkarmayın.
- AC ve DC gücü kapatın ve invertörden ayırın, bağlı devrelerde herhangi bir bakım, temizlik veya çalışma yapmadan önce gerilimin tamamen boşalması için 5 dakika bekleyin.
- Giriş DC geriliminin invertörün maksimum DC giriş geriliminden az veya buna eşit olduğundan emin olun. Aşırı gerilim invertörde garanti kapsamına girmeyen kalıcı hasara neden olabilir.

DİKKAT!

- Çocukları invertörden uzak tutun.
- İnvertörün ağırlığına dikkat edin. Doğru şekilde kullanılmazsa kişisel yaralanmalara neden olabilir.

BİLDİRİ!











- Yerel düzenlemeler tarafından harici bir RCD gerekirse ilgili elektrik kodları için hangi tür RCD'nin gerekli olduğunu kontrol edin. 300 mA değerinde bir Tip A RCD kullanılması önerilir.
- İnvertördeki tüm ürün etiketleri ve isim plakası açıkça görülebilmelidir.

Segurança

Aviso Geral

1. Os conteúdos podem ser periodicamente atualizados ou revistos. A SolaX se reserva o direito de efetuar melhorias ou mudanças no(s) produto(s) e no(s) programa(s) descrito(s) neste manual sem aviso prévio.
2. A instalação, a manutenção e a configuração relativa à rede apenas podem ser realizadas por pessoal qualificado que:
 - É licenciado e/ou satisfaz aos regulamentos das jurisdições estaduais e locais;
 - Tem bons conhecimentos sobre este manual e outros documentos relacionados.
3. Antes da instalação do dispositivo, leia cuidadosamente, entenda totalmente e siga rigorosamente as instruções detalhadas do manual do usuário e de outros regulamentos relevantes. A SolaX será responsável por quaisquer consequências causadas pela violação dos regulamentos de armazenamento, transporte, instalação e regulamentos de operação especificados neste documento e no manual do usuário.
4. Utilize as ferramentas isoladas ao instalar o dispositivo. As ferramentas de proteção individuais devem ser usadas durante a instalação, a conexão elétrica e a manutenção.
5. Por favor visite o site eletrônico www.solaxpower.com da SolaX para mais detalhes.

Descrições dos Rótulos

	Marca CE de conformidade		Certificação TUV
	Atenção, risco de choque elétrico		Atenção, risco de perigo
	Leia as documentações em anexo		Não descarte o inversor juntamente com resíduos domésticos.
	Atenção, superfície quente		
	Ponto de aterramento adicional		
	Não opere esse inversor até que ele esteja isolado da rede elétrica e dos fornecedores de geração fotovoltaica no local.		
	Perigo de alta tensão. Não toque em partes vivas por 5 minutos após a desconexão da fonte de alimentação.		

 PERIGO!

Perigo de morte por choque elétrico devido ao inversor

- Somente opere o inversor quando ele não estiver tecnicamente defeituoso. Caso contrário, pode ocorrer choque elétrico ou incêndio.
- Não abra o invólucro em qualquer caso sem autorização da SolaX. A abertura não autorizada violará a garantia e causará perigo de morte ou ferimentos graves devido ao choque elétrico.

 PERIGO!

Perigo de morte de choque elétrico devido à FV

- Quando exposto à luz solar, a alta tensão CC será gerada pelos módulos FV. Ocorrerá morte ou lesões graves devido a choque elétrico.
- Nunca toque no pólo positivo ou negativo do dispositivo de conexão FV. Também é proibido tocar em ambos ao mesmo tempo.
- Não aterre o pólo positivo ou negativo dos módulos FV.
- Somente pessoal qualificado pode realizar a cablagem dos painéis FV.

 ADVERTÊNCIA!

Risco de ferimentos pessoais ou danos ao inversor

- Durante a operação, não toque em nenhuma parte que não seja o interruptor CC e o painel LCD.
- Nunca ligue ou desligue os conectores CA e CC quando o inversor estiver funcionando.
- Desligue a energia CA e CC e desconecte-as do inversor, aguarde por 5 minutos para descarregar totalmente a tensão antes de tentar fazer qualquer manutenção, limpeza ou trabalho em qualquer circuito conectado.
- Certifique-se de que a tensão de entrada CC seja \leq a tensão de entrada CC máxima do inversor. A sobretensão pode causar dano permanente ao inversor, o que NÃO é coberto pela garantia.

 ATENÇÃO!

- Mantenha-se a criança longe do inversor.
- Preste atenção ao peso do inversor. Os ferimentos pessoais podem ser causados se não forem tratados adequadamente.

AVISO!

- Se um RCD externo for necessário pelos regulamentos locais, verifique em que tipo de RCD é exigido pelos códigos elétricos relevantes. É recomendado usar um RCD do Tipo-A com o valor de 300mA.
- Todos os rótulos e placas de identificação do produto no inversor devem ser mantidos claramente visíveis.

Packing List / Packliste / Liste du matériel livré / Lista de piezas / Lista da embalagem / Paklijst / Contenuto della confezione / Zawartość opakowania / Seznam balení / Packlista / Listă de ambalare / Опаковъчен лист / Pakkeliste / Λίστα συσκευασίας / Pakkeleht / Pakkausluettelo / Popis pakiranja / Csomaglista / Pakuotės turinys / Iepakojuma saraksts / Zoznam položiek balenia / Seznam pakiranja / Kutu Listesii / Lista de Embalagem

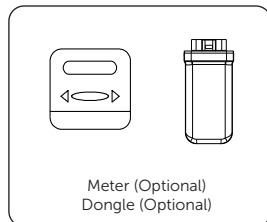
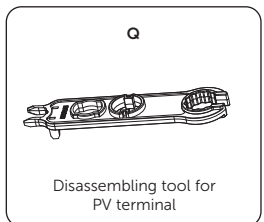
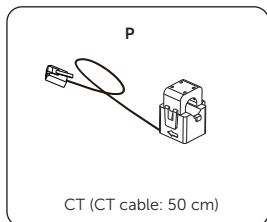
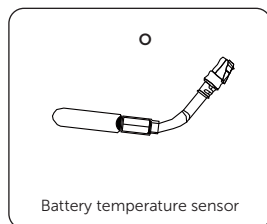
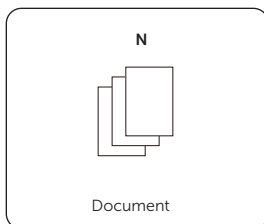
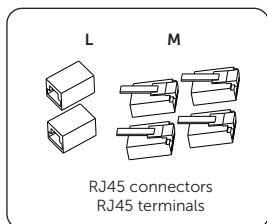
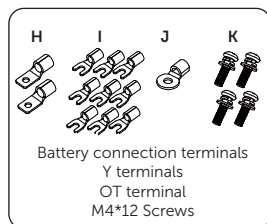
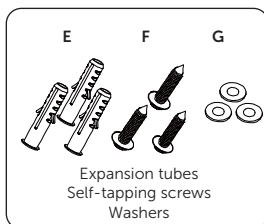
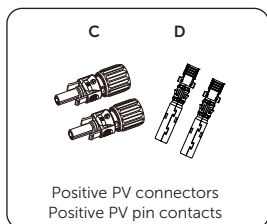
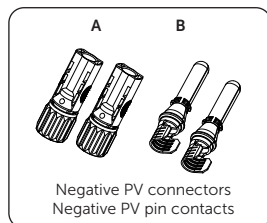
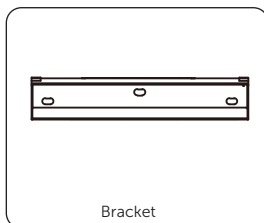
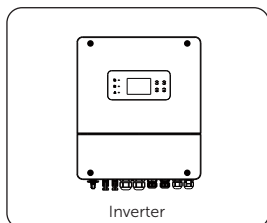

Item	Description	Quantity
/	Inverter	1 pc
/	Wall mounting bracket	1 pc
A	Negative PV connectors	2 pcs
B	Negative PV pin contacts	2 pcs

Item	Description	Quantity
C	Positive PV connectors	2 pcs
D	Positive PV contacts	2 pcs
E	Expansion tubes	3 pcs
F	Self-tapping screws	3 pcs
G	Washers	3 pcs
H	Battery connection terminals	2 pcs
I	Y terminals	9 pcs
J	OT terminal	1 pc
K	M4*12 Screws	4 pcs
L	RJ45 connectors	2 pcs
M	RJ45 terminals	4 pcs
N	Document	/
O	Battery temperature sensor	1 pc
P	CT (CT cable: 50 cm)	1 pc
Q	Disassembling tool for PV terminal	1 pc
/	Dongle (Optional)	1 pc
/	Meter (Optional)	1 pc

* Please refer to the actual delivery for the optional accessories.

Installation Site / Installationsort / Site d'installation / Sitio de instalación / Local de instalação / Installatiesite / Sito di installazione / Miejsce instalacji / Místo instalace / Installationsplats / Loc de instalare / Монтажен объект / Monteringssted / Τόπος εγκατάστασης / Paigaldamise koht / Asennuspaikka / Lokacija ugradnje / Telepitési helyszín / Montavimo vieta / Uzstādīšanas vieta / Miesto inštalácie / Mesto namestitve / Kurulum Yeri / Local de Instalação

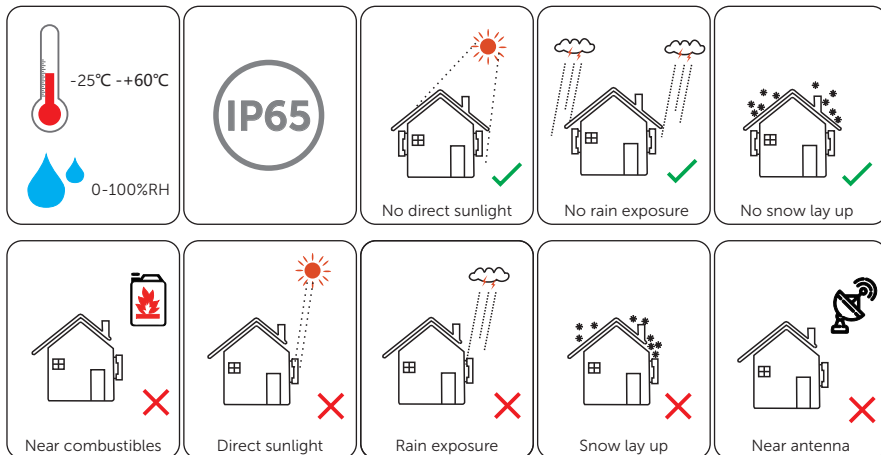

Installation Carrier / Installationsträger / Partie porteuse / Soporte de instalación / Suporte de Instalação / Installatiedrager / Supporto di installazione / Powierzchnia montażowa / Nosič instalace / Installationsfästen / Suport instalație / Монтажна основа / Monteringsholder / Μεταφορέας εγκατάστασης / Paigalduskandja / Asennusteline / Nosač za ugradnju / Telepitési szolgáltató / Montavimo pagrindas / Instalācijas turētājs / Noslāņ konstrukcija pre inštalāciju / Namestitveni nosilec / Kurulum Taşıyıcı / Portador de Instalação

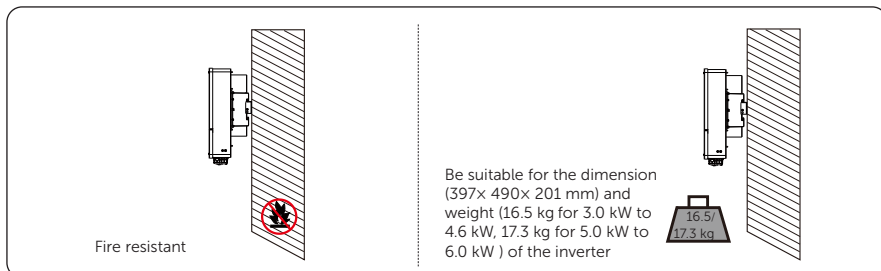

Installation Angle / Installationswinkel / Angle d'installation / Ángulo de instalación / Ângulo de instalação / Installatiehoek / Angolazione di installazione / Kąt instalacji / Instalační úhel / Installationsvinkel / Unghi de instalare / Монтажен ъгъл / Μοντερίνγκ γωνία εγκατάστασης / Paigaldusnurk / Asennuskulma / Kut ugradnje / Telepítési szög / Montavimo kampas / Uzstādīšanas leņķis / Uhol inštalácie / Namestitveni kot / Kurulum Açısı / Ângulo de Instalação

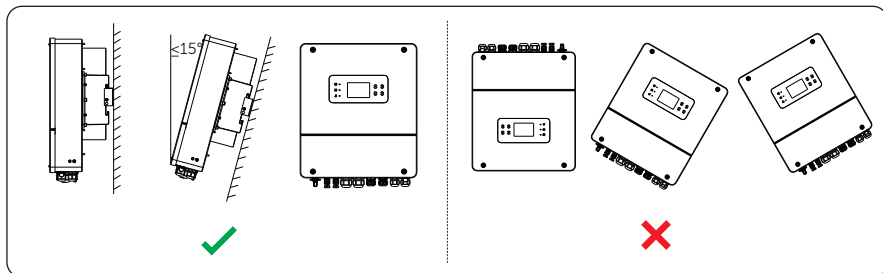

Installation Space / Installationsraum / Espace d'installation / Espacio de instalación / Espaço de instalação / Installatieruimte / Spazio di installazione / Przestrzeń instalacyjna / Instalační prostor / Installationsutrymme / Spațiu de instalare / Μοντερίνγκ пространство / Monteringsplads / Χώρος εγκατάστασης / Paigaldusruum / Asennustila / Mjesto ugradnje / Telepítési tér / Montavimo erdvė / Uzstādīšanas telpa / Priestor pre inštaláciu / Prostor za namestitev / Kurulum Alanı / Espaço de Instalação

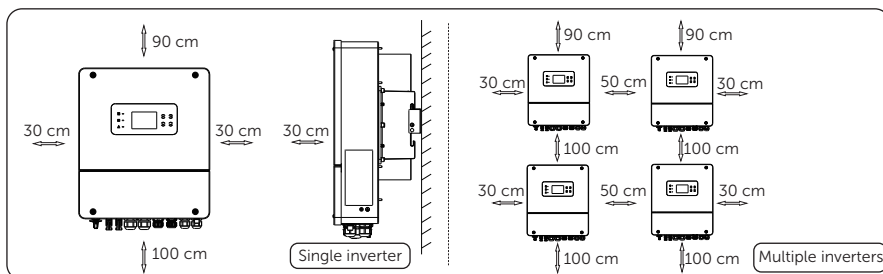

* It is recommended to install the inverter more than 100 cm above the ground. The minimum clearance reserved for the connected terminal at the bottom of inverter should be 10 cm. When planning installation space, it is important to simultaneously consider the bending radius of the wires.

Installation Tools / Installationswerkzeuge / Outils d'installation / Herramientas de instalación / Ferramentas de instalação / Installatiemiddelen / Utensili di installazione / Narzędzia do instalacji / Instalační nástroje / Verktyg för installation / Instrumente de instalare / Монтажни инструменти / Monteringsværktøjer / Εργαλεία εγκατάστασης / Paigaldamise tööriistad / Asennustyökalut / Alati za ugradnju / Telepitő eszközök / Montavimo įrankiai / Uzstādīšanas instrumenti / Nástroje pre inštaláciu / Orodja za namestitev / Kurulum Araçları / Ferramentas de Instalação



Hammer drill



Multimeter

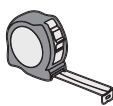

Measuring tape



Utility knife



Marker



Cross screwdriver



Flat-head screwdriver

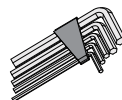

Allen key

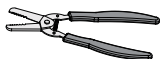

Wire stripper

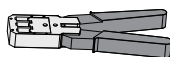

Crimping tool for RJ45

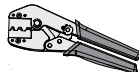

Crimping tool for PV terminals



Diagonal pliers

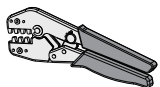

Crimping tool

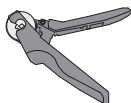

Crimping tool for ferrules

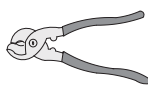

Wire cutter

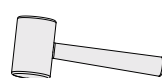

Rubber mallet

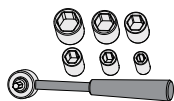

Torque wrench



Spirit level

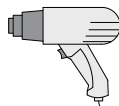

Heat gun

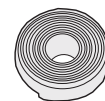

Φ6 mm Heat shrink tubing



Safety gloves



Safety boots



Safety goggles

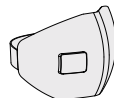

Anti-dust mask

Additionally Required Materials / Zusätzlich erforderliche Materialien / Matériaux supplémentaires requis / Materiales adicionales necesarios / Materiais Adicionais Necessários / Extra benodigde materialmen / Materiali aggiuntivi necessary / Materiały wymagane dodatkowo / Další požadované materiály / Ytterligere materialkrav / Materiale suplimentare necesare / Други необхідими матеріали / Yderligere nødvendige materialer / Πρόσθετα απαιτούμενα υλικά / Täiendavad vajalikud materjalid / Muut vaaditud materiaalit / Potrebni dodatni materijali / További szűkséges anyagok / Papildomos reikalingos medžiagos / Papildus vajadzīgie materiāli / Dodatočne požadované materiály / Dodatno zahtevani materiali / Ayrıca Gerekli Malzemeler / Materiais Adicionais Necessários

No.	Required Material	Type	Conductor Cross-section
1	PV cable	Dedicated PV wire withstand voltage 600 V	4 mm ²
2	Communication cable	Network cable CAT5	0.2 mm ²
3	Additional PE cable	Conventional yellow and green wire	4 mm ² -10 mm ²
4	Battery power cable	Conventional copper wire	16-25mm ² or 35-50 mm ²

- Grid cable and micro-breaker recommended:

Model	X1-HYB-3.0-LV	X1-HYB-3.7-LV	X1-HYB-4.0-LV	X1-HYB-4.6-LV	X1-HYB-5.0-LV	X1-HYB-6.0-LV
Cable (copper)	4-6 mm ²	6-8 mm ²	6-8 mm ²	8-10 mm ²	8-10 mm ²	8-10 mm ²
Micro-Breaker	32 A	40 A	40 A	50 A	50 A	50 A

- EPS cable and micro-breaker recommended:

Model	X1-HYB-3.0-LV	X1-HYB-3.7-LV	X1-HYB-4.0-LV	X1-HYB-4.6-LV	X1-HYB-5.0-LV	X1-HYB-6.0-LV
Cable (copper)	3-4 mm ²	3-4 mm ²	3-4 mm ²	4-6 mm ²	4-6 mm ²	6-8 mm ²
Micro-Breaker	25 A	25 A	25 A	32 A	32 A	40 A

- GEN cable and micro-breaker recommended:

Model	X1-HYB-3.0-LV	X1-HYB-3.7-LV	X1-HYB-4.0-LV	X1-HYB-4.6-LV	X1-HYB-5.0-LV	X1-HYB-6.0-LV
Cable (copper)	3-4 mm ²	3-4 mm ²	3-4 mm ²	4-6 mm ²	4-6 mm ²	6-8 mm ²
Micro-Breaker	25 A	25 A	25 A	32 A	32 A	40 A

Mechanical Installation / Mechanische Installatie / Installation mécanique / Instalación mecánica / Instalação mecânica / Mechanische installatie / Installazione meccanica / Instalacja mechaniczna / Mechanická instalace / Mekanisk installation / Μηχανική εγκατάσταση / Mehaaniline paigaldus / Mekaaninen asennus / Mehanička ugradnja / Mechanikai telepítés / Mechaninis montavimas / Mehāniskā uzstādīšana / Mechanická inštalácia / Mehanska namestitve / Mekanik Kurulum / Instalação Mecânica

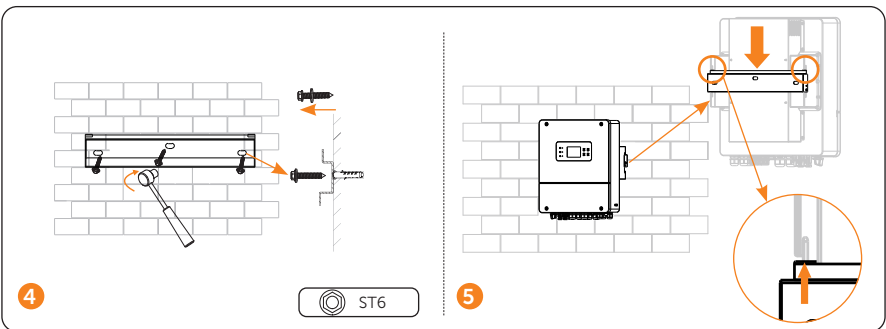
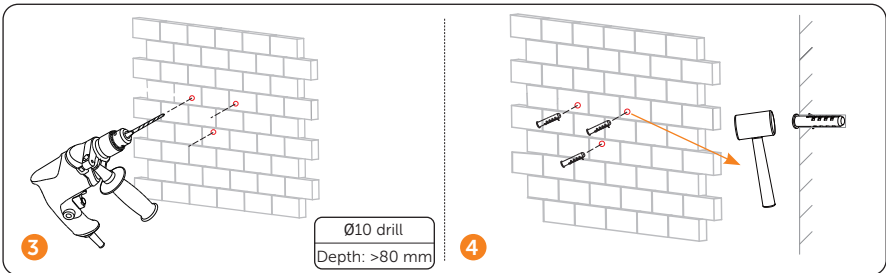
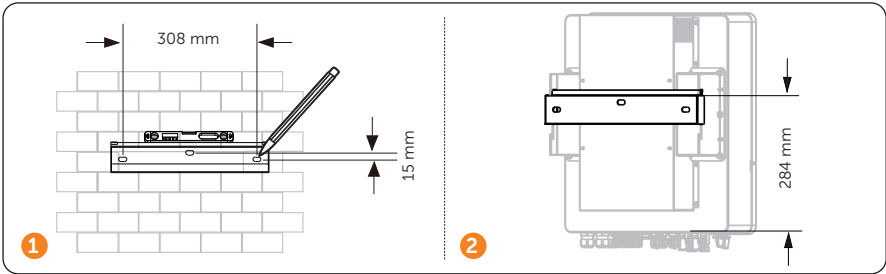

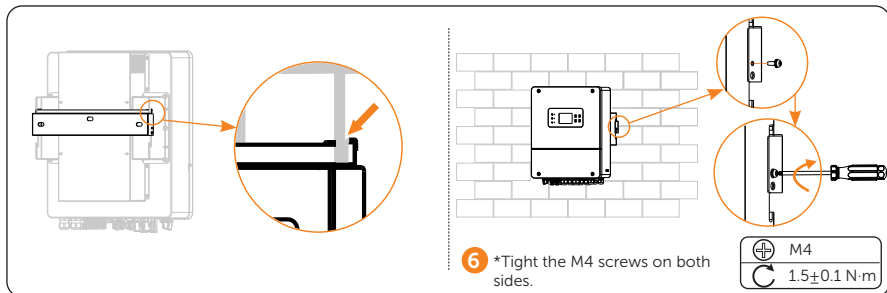

PE Connection / Schutzerdungs-Anschluss / Connexion PE / Conexión PE / Ligação à Terra / PE-aansluiting / Collegamento PE / Połączenie PE / PE připojení / PE-anslutning / Conexiune PE / PE връзка (земя) / Jordforbindelse / Σύνδεση PE / PE ühendus / PE-yhteys / PE priključak / PE bekötés / PE (apsauginio įžeminimo) kontaktas / PE savienojums / Pripojenie ochranného vodiča / PE povezava / PE Bağlantısı / Conexão PE

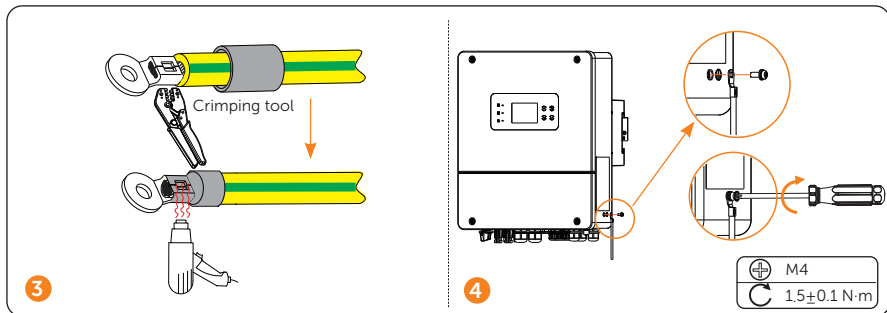
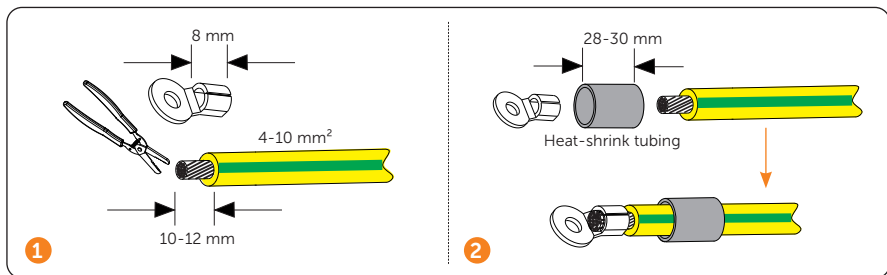

• PE cable recommended:

Model	X1-HYB-3.0-LV	X1-HYB-3.7-LV	X1-HYB-4.0-LV	X1-HYB-4.6-LV	X1-HYB-5.0-LV	X1-HYB-6.0-LV
PE cable	4-6 mm ²	6-8 mm ²	6-8 mm ²	8-10 mm ²	8-10 mm ²	8-10 mm ²

GRID, EPS and GEN Connection / Netz-, EPS- und GEN-Verbindung / Connexion au réseau, à l'EPS et au GEN / Conexión de red, EPS y GEN / Conexão de rede, EPS e GEN / Net-, EPS- en GEN-verbinding / Collegamento alla rete, all'EPS e al GEN / Połączenie z siecią, EPS i GEN / Připojení k síti, EPS a GEN / Nät-, EPS- och GEN-anslutning / Conexiune la rețea, EPS și GEN / Връзка с мрежата, EPS и GEN / Grid-, EPS- og GEN-tilslutning / Σύνδεση με το δίκτυο, το EPS και το GEN / Vörgu-, EPS- ja GEN-ühendus / Verkko-, EPS- ja GEN-liitäntä / Povezivanje na mrežu, EPS i GEN / Hálózat-, EPS- és GEN-csatlakozás / Tinklo, EPS ir GEN ryšys / Tikla, EPS un GEN savienojums / Pripojenie k sieti, EPS a GEN / Povezava na omrežje, EPS in GEN / Ağ, EPS ve GEN Bağlantısı / Conexão à rede, EPS e GEN

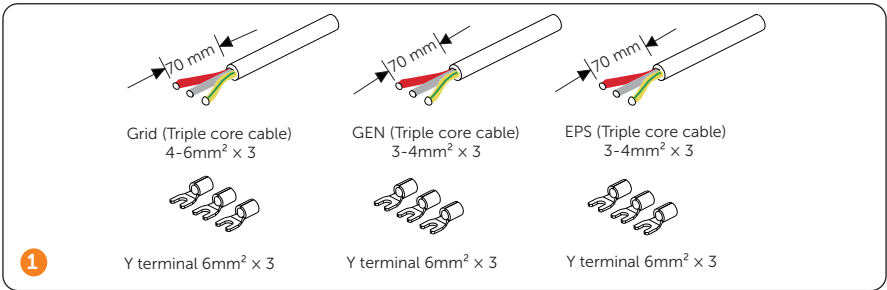

* Please refer to the table in **Additionally Required Materials** to view the recommended wire sizes for GRID, EPS, and GEN.

* It is recommended to use copper wire. Non-triple or non-dual core cables shall be sealed with glue or fireproof mud.

* When using wire sizes of 6 mm² and above, only 2-core wires can be used because the 3-core wire cannot pass through the waterproof terminal. In the case of using 2-core wire, the PE wire should only be connected to the inverter shell and does not need to be connected to the internal terminals.

* All connection diagrams provided here are based on the use of a 3-core wire, with X1-HYB-3.0-LV serving as an example.

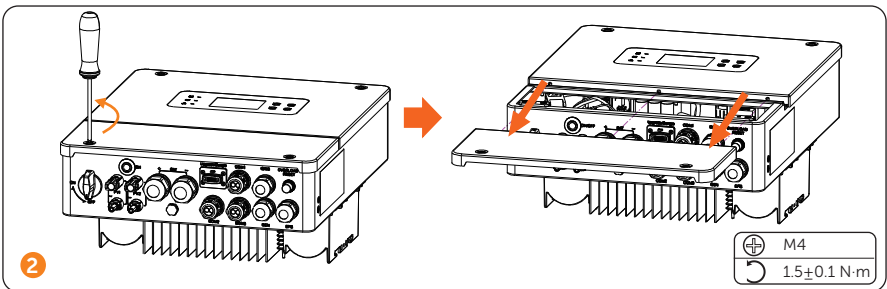

Remove the plug of EPS, GEN and Grid ports.

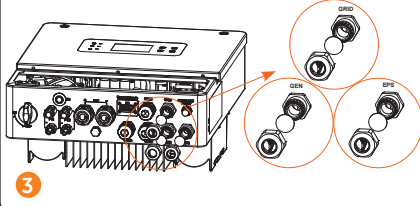

3

4

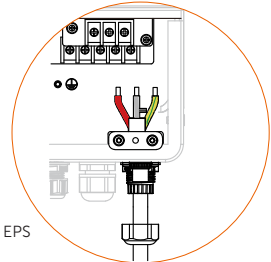
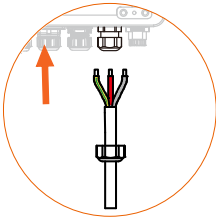
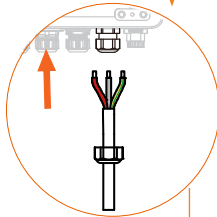
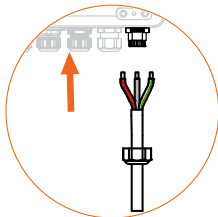
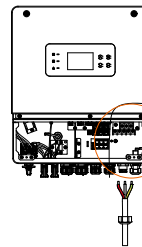
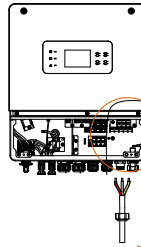
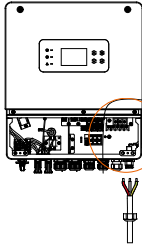
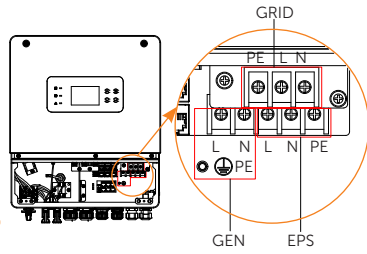

EPS

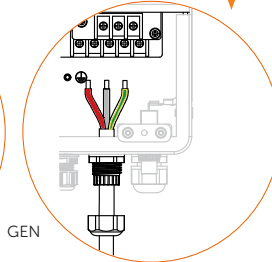

GEN

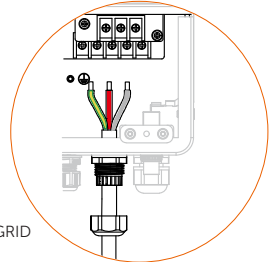

GRID

5 * The EPS, GEN and Grid cables go through the corresponding EPS, GEN and Grid ports.

Diagonal plier

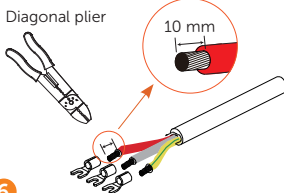

10 mm

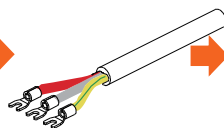

Crimping tool

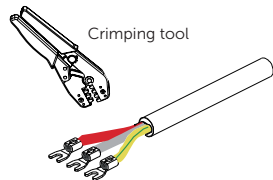

6

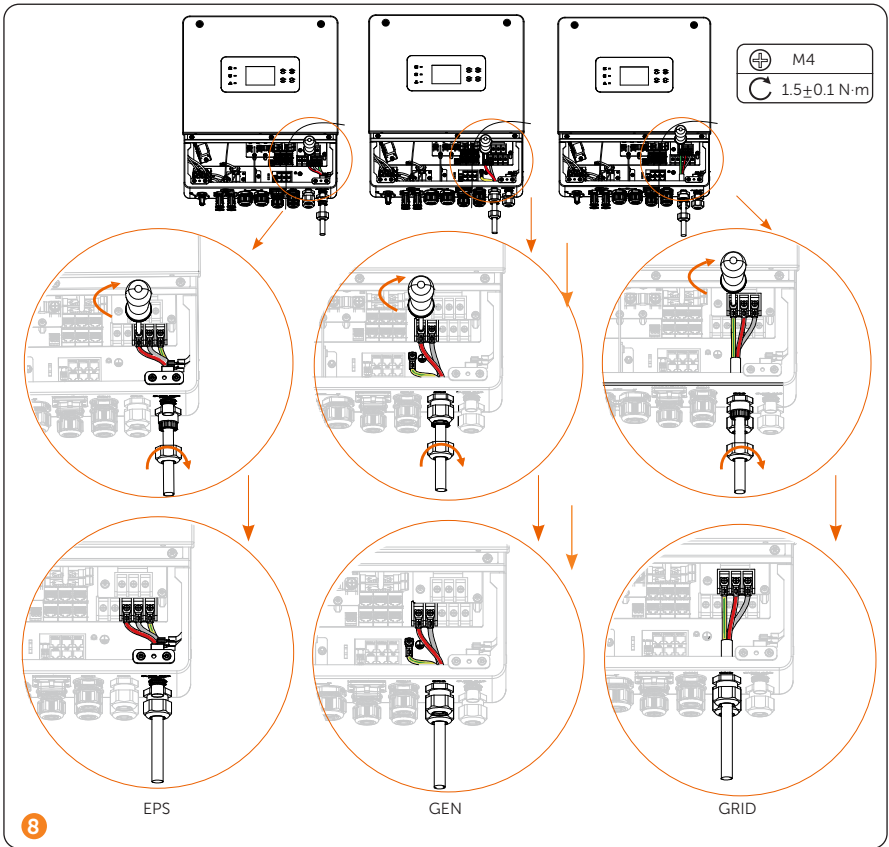
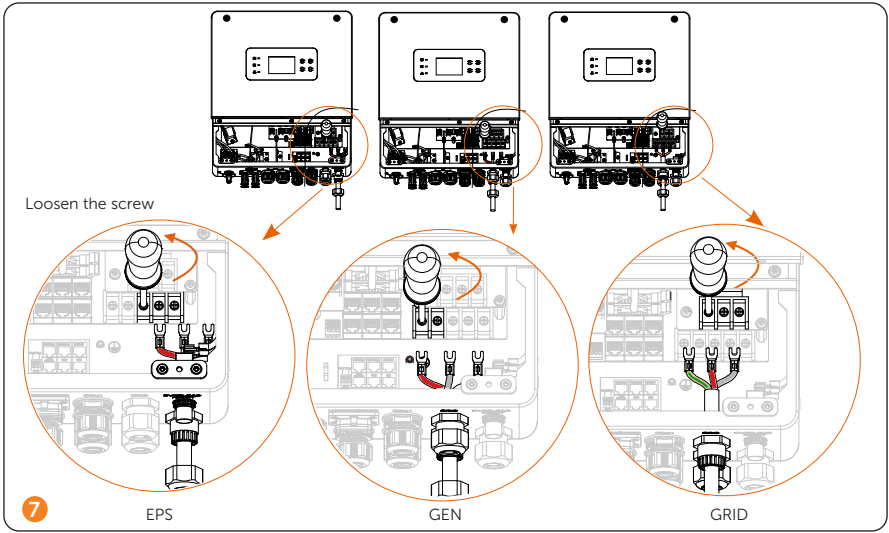

PV Connection / PV-Anschluss / Connexion PV / Conexión FV / Ligação PV (Fotovoltaica) / PV-aansluiting / Collegamento PV / Połączenie PV / Připojení FV / Anslutning av solcellsanläggning / Conexiune PV / Връзка с PV / PV-tilslutning / Σύνδεση φωτοβολταϊκού / PV-ühendus / PV-liitântä / Fotonaopnski priključak / PV bekötés / Fotovoltinè jungtis / PV savienojums / Pripojenie fotovoltaičky (FV) / Povezava fotonapetostnega kabla (PV) / PV Bağlantısı / Conexão PV

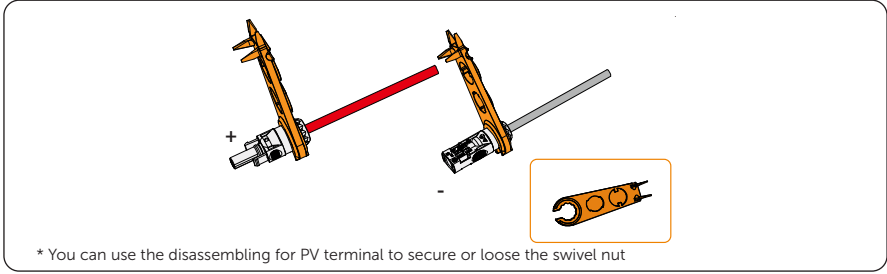
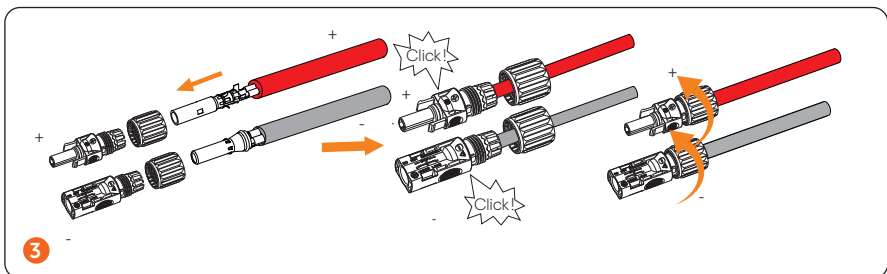
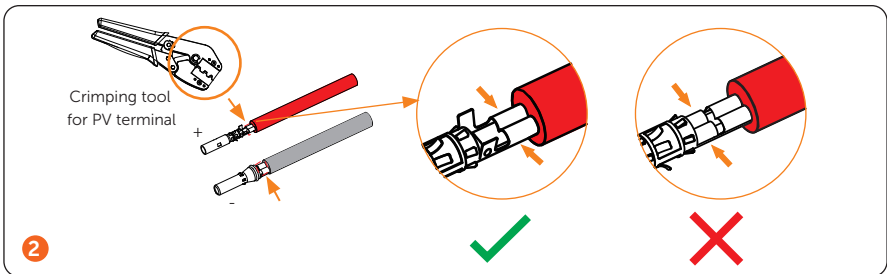
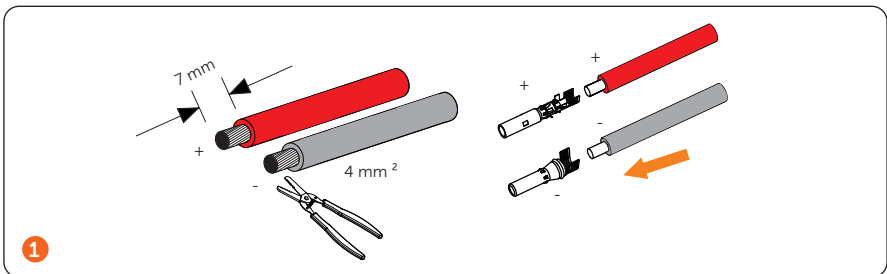

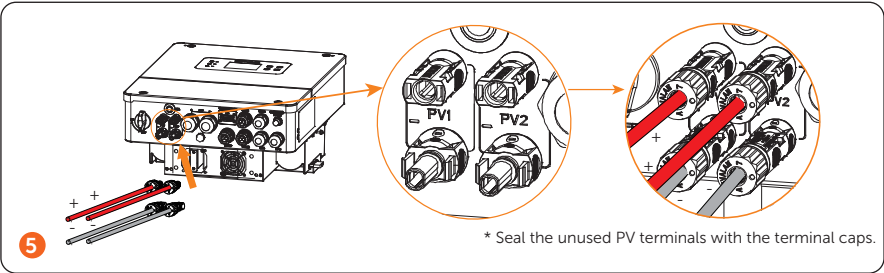
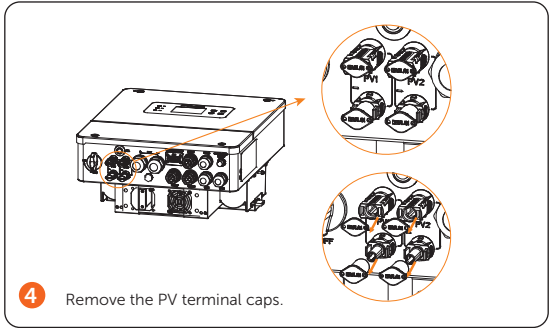
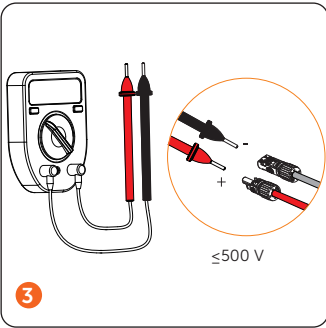

Disassembling the PV cables

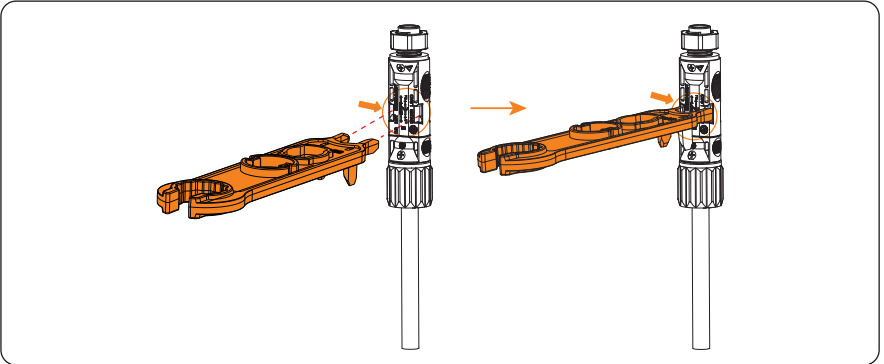

Battery Connection / Batterieanschluss / Branchement de la batterie / Conexión de la batería / Ligação da bateria / Batterij-aansluiting / Collegamento della batteria / Połączenie akumulatora / Připojení baterie / Batterianslutning / Conectare baterie / Връзка с батерията / Batteritilslutning / Σύνδεση μπαταρίας / Akuühendus / Akun liitântä / Priključak za bateriju / Akumulátor bekötés / Akumulatoriaus jungtis / Akumulatora savienojums / Pripojenie batérie / Povezava baterije / Pil Bağlantısı / Conexão da bateria

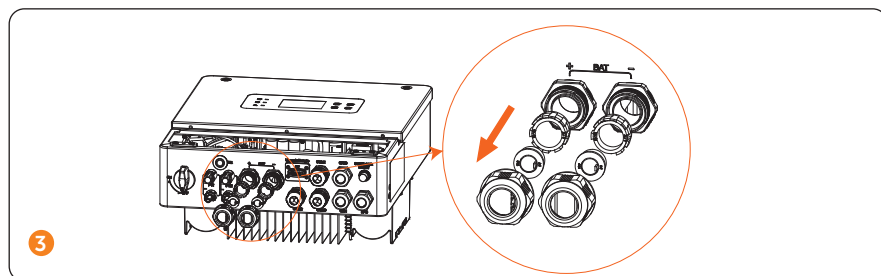
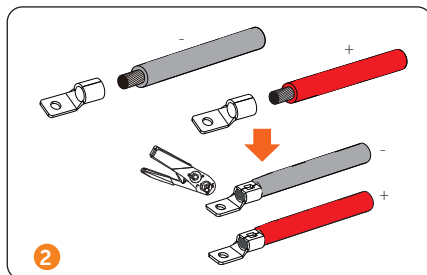
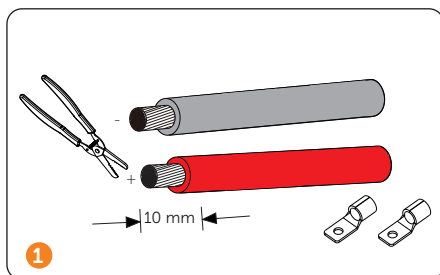

* If only the battery is connected but the PV, GRID, and GEN are not connected, to start the inverter, press and hold the battery power on button until the screen is on.

- Battery connection for 3.0 kW to 4.0 kW

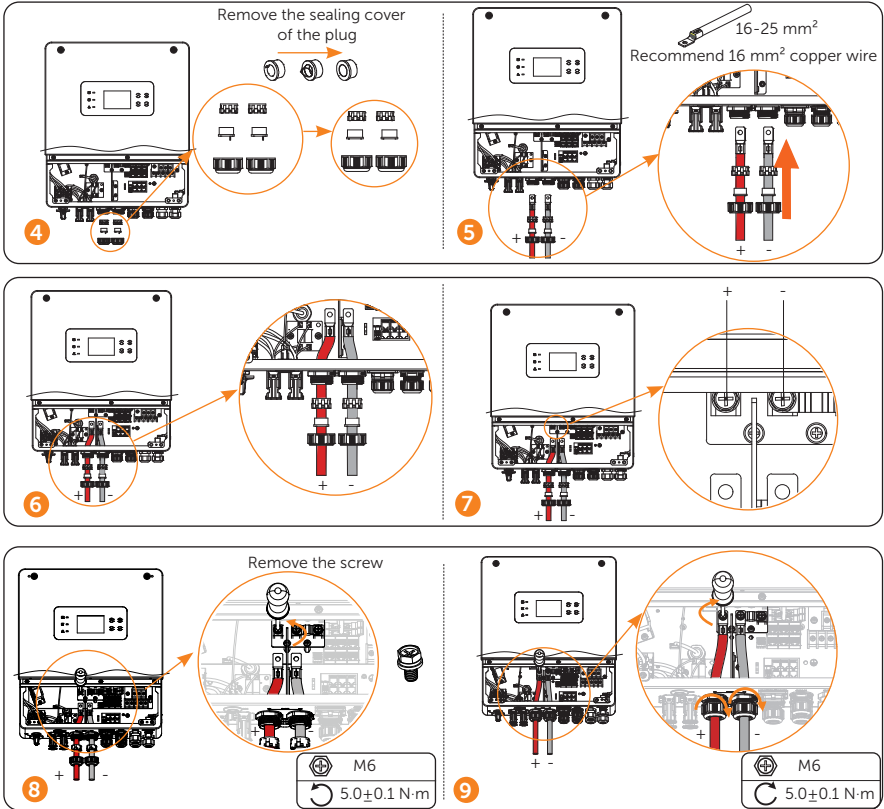

- Battery connection for 4.6 kW to 6.0 kW

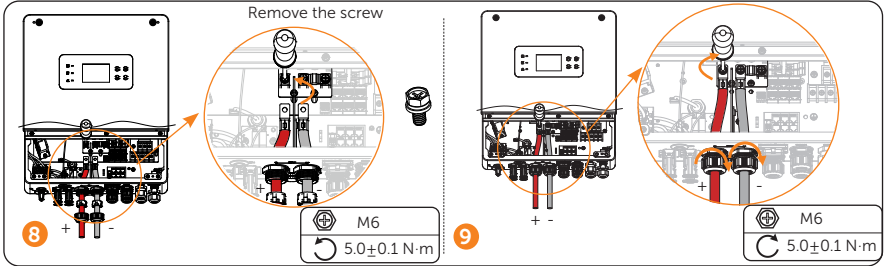
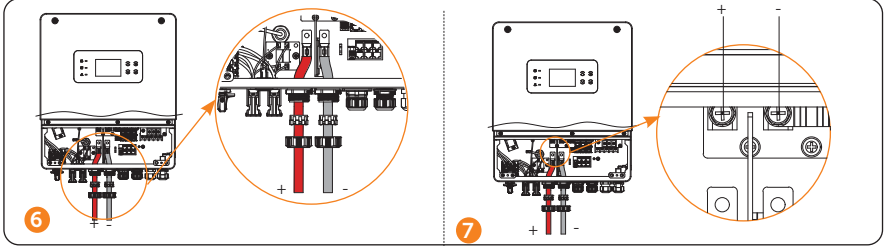
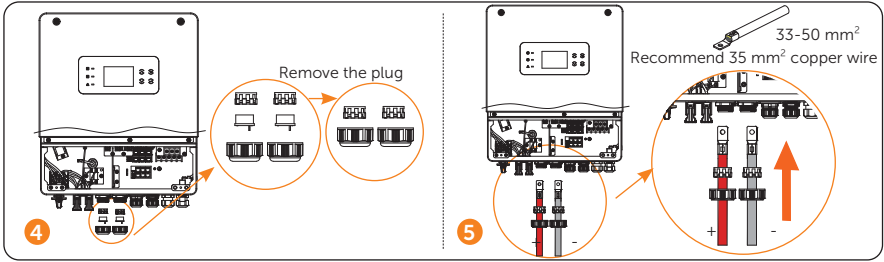

- Battery temperature sensor connection

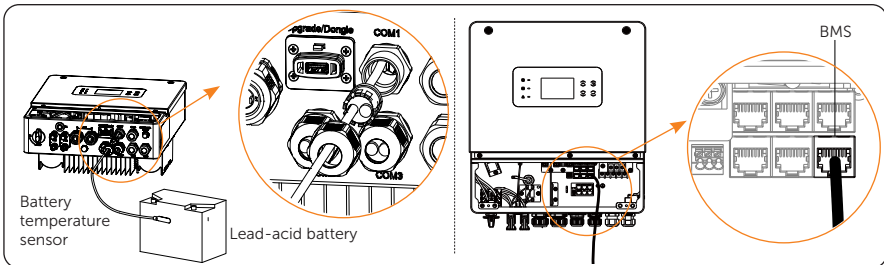

Communication Connection / Kommunikations-Anschluss / Branchement de communication / Conexión de comunicaci3n / Ligaç3o à Comunicaç3o / Communicatie-aansluiting / Collegamento comunicazione / Połączenie komunikacyjne / Komunikační pøipojení / Kommunikationsanslutning / Conexiune de comunicare / Коммуникационная вøязка / Kommunikationsforbindelse / Σύνδεση επικοινωνίας/Sideühendus / Tiedonsiirtoliitântä / Pøikljuèak za komunikaciju / Kommunikaci3s bek3t3s / Duomenų ryšys / Sakaru savienojums / Pøipojenie komunikácie / Komunikacijska povezava / İletişim Baęlantısı / Conex3o de Comunicaç3o

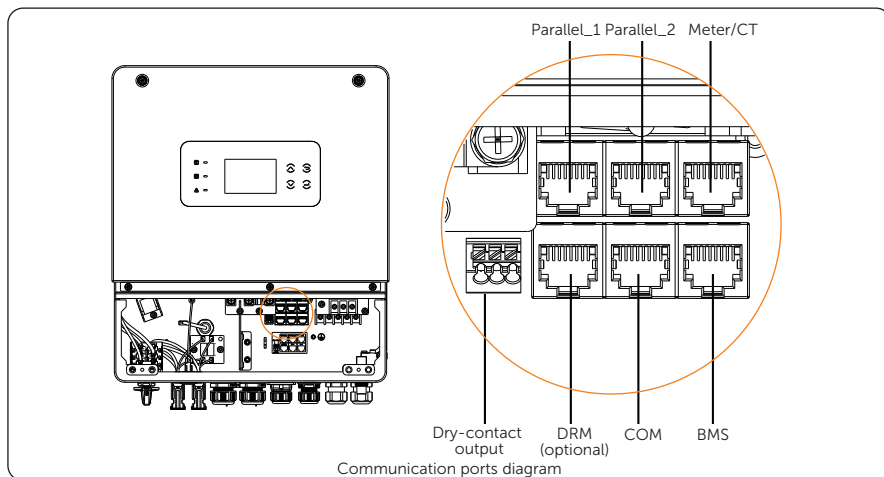

* For Communication connection, you can select any port from COM 1, COM 2 and COM3.

- CT/ Meter port connection

1. CT connection diagram

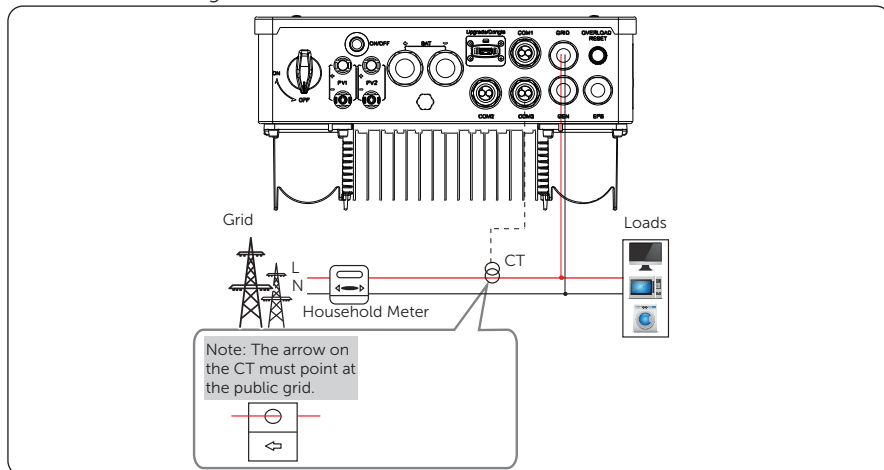

2. Meter connection diagram

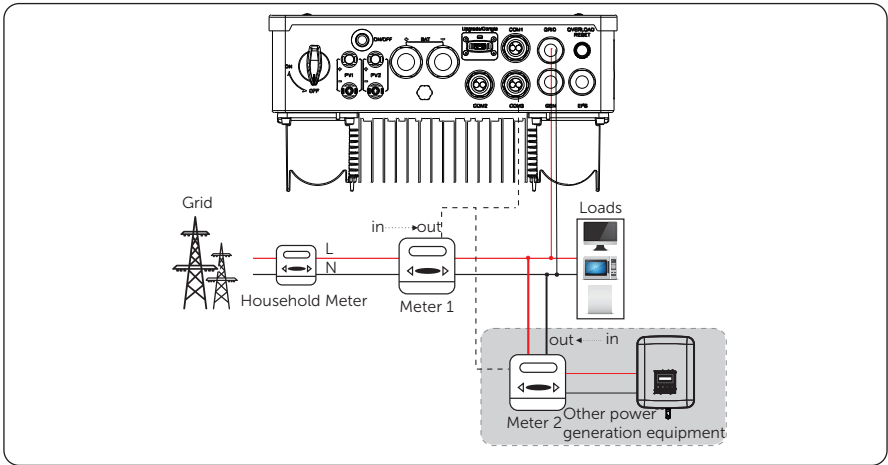

* If two meters were to be connected in the system, the communication cables of the meters should be connected in parallel, i.e. 485A & 485A, 485B & 485B.

3. Pin definition for Meter/CT

Pin	1	2	3	4	5	6	7	8
Pin Definition	CT1-1	X	X	RS485_A	RS485_B	X	X	CT1-2

* Only one of the Meter and CT connections can be selected. Meter cable goes to pin terminal 4 and 5; CT cable goes to pin terminal 3 and 6.

4. CT/Meter connection steps

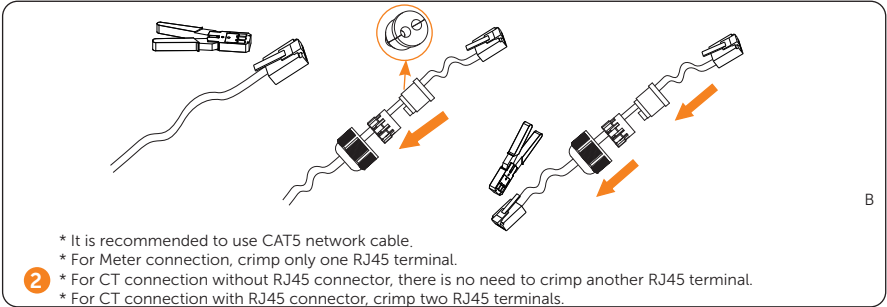
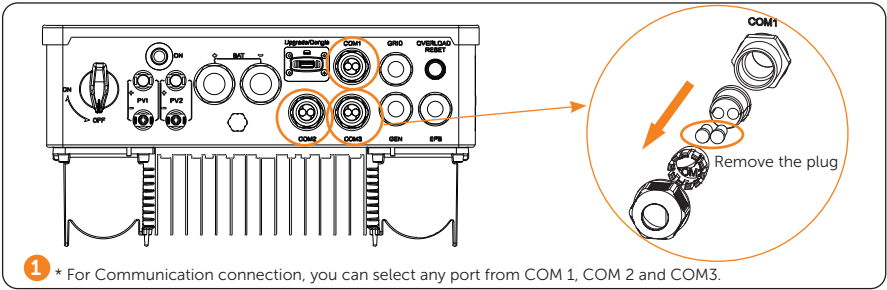

• Meter connection

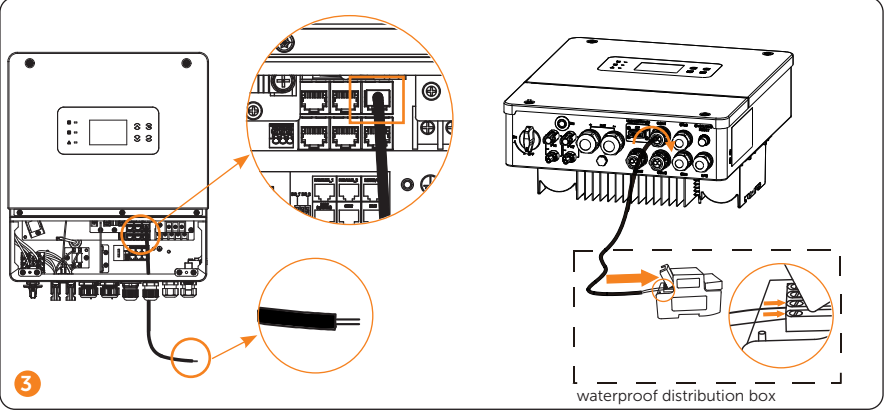

• CT connection

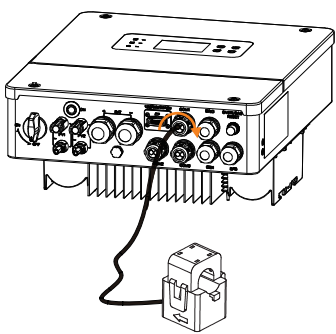
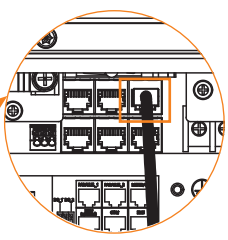
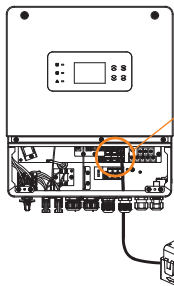

3

CT connection without RJ45 connector

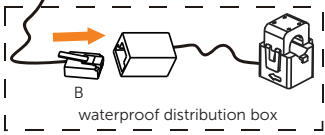
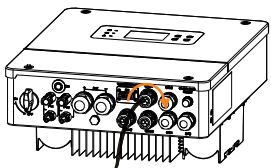
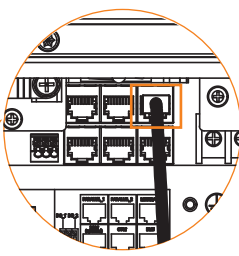
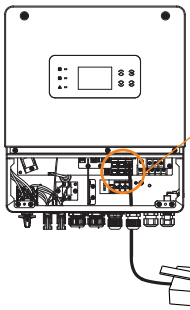

3

CT connection with RJ45 connector

- BMS/DRM/COM port connection

1. BMS

- 1.1 Lithium battery connection diagram

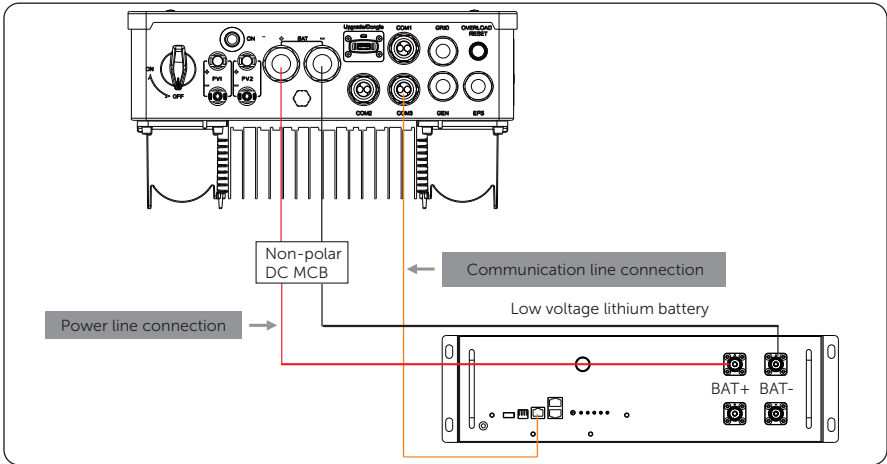

- 1.2 Pin definition for BMS

Pin	1	2	3	4	5	6	7	8
Pin Definition	BMS_485B	BMS_485A	GND	BMS_CANH	BMS_CANL	X	GND	BAT_TEMP

2. Pin definition for DRM (0)

Pin	1	2	3	4	5	6	7	8
Pin Definition	DRM1/5	DRM2/6	DRM3/7	DRM4/8	RG/0	CL/0	X	X

3. Pin definition for COM

Pin	1	2	3	4	5	6	7	8
Pin Definition	Dry-contact_in1	Dry-contact_in2	X	RS485_A	RS485_B	GND	X	X

4. BMS/DRM/COM connection steps

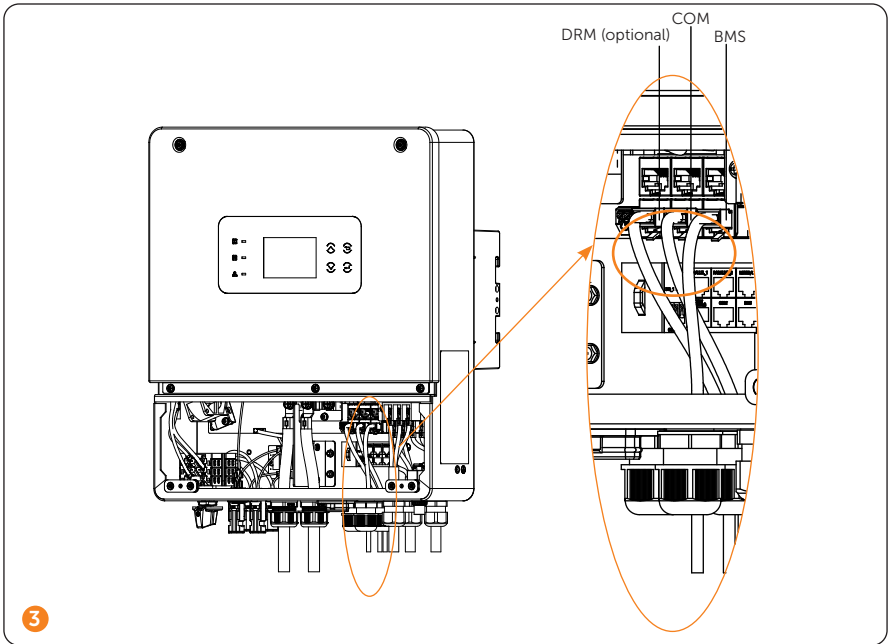
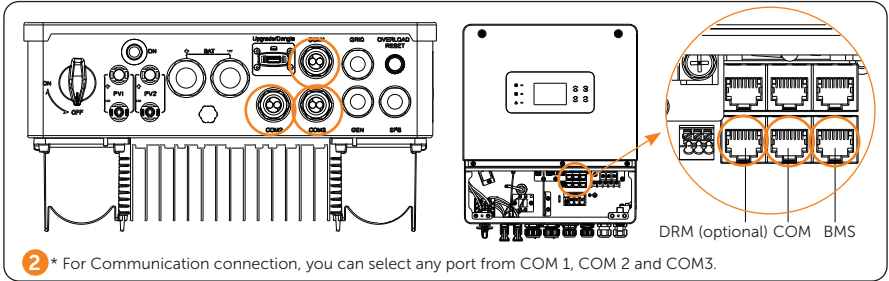
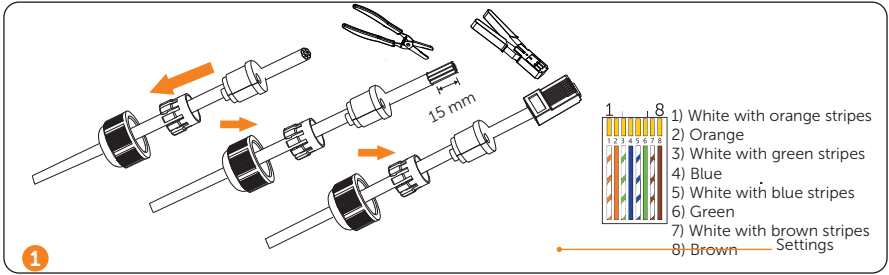

- Parallel connection connection

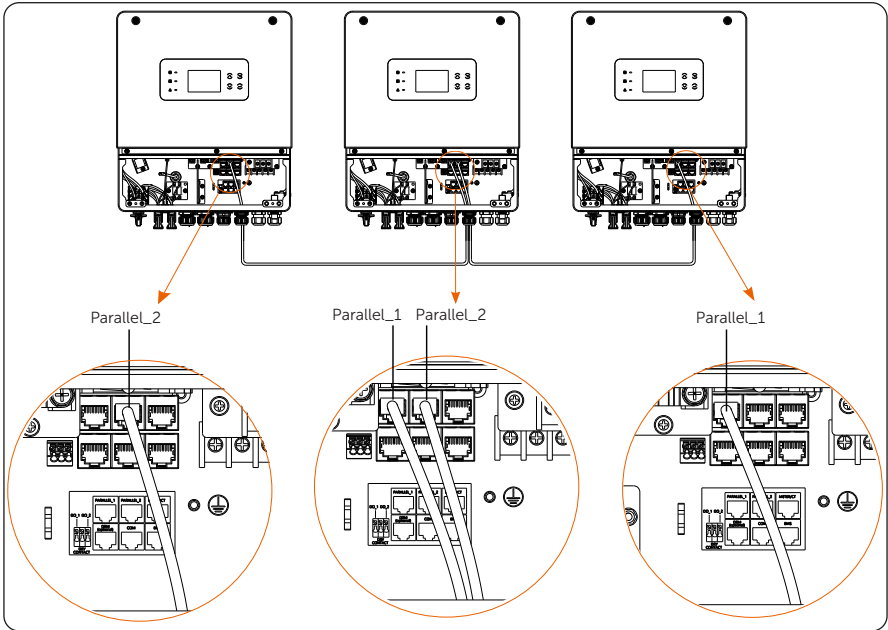

Parallel connection diagram

* Parallel cable making method is the same as BMS/DRM/COM.

* In parallel operation, if there are PV modules, the master inverter must be connected to the PV modules.

- Dry-contact output connection

- Dry-contact output connection diagram

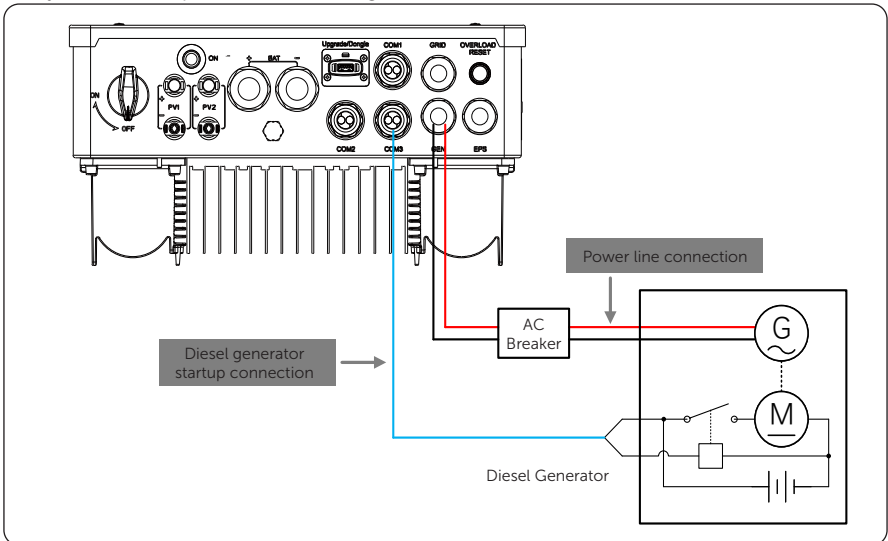

2. Dry-contact output connection steps

1) White with orange stripes
 2) Orange
 3) White with green stripes
 4) Blue
 5) White with blue stripes
 6) Green
 7) White with brown stripes
 8) Brown

* It is recommended to use CAT5 network cable.

1 * For dry-contact output connection, you can select any two cables from the following four groups: white with orange stripes, Orange, white with green stripes, blue; white with blue stripes, green; white with brown stripes, brown.

2 * For Communication connection, you can select any port from COM 1, COM 2 and COM3.

3

4

5

M4
 1.5±0.1 N·m

Monitoring Connection / Überwachungs-Anschluss / Branchement de surveillance / Conexión de monitorización / Ligação à Monitorização / Monitoring-aansluiting / Collegamento monitoraggio / Potężenie na potrzeby monitorowania / Připojení ke sledování / Övervakningsanslutning / Conexiune de monitorizare / Мониторингова връзка / Övervakningsforbindelse / Σύνδεση παρακολούθησης / Seire ühendus / Valvontaliitäntä / Priključak za nadzor / Monitoring bekötés / Stebėjimo ryšys / Uzraudzības savienojums / Pripojenie monitorovania / Povezava za spremljanje / İzleme Bağlantısı / Conexão de Monitoramento

WiFi Mode:

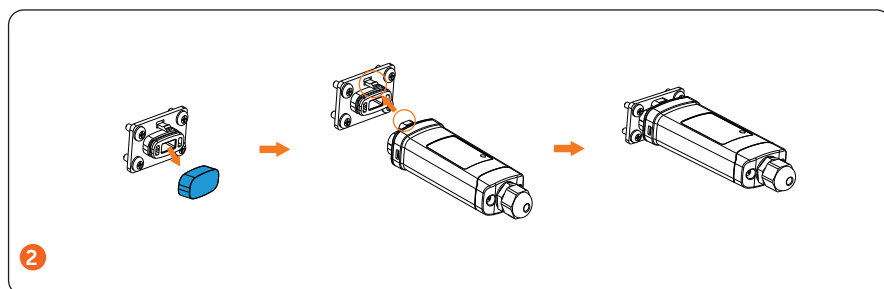
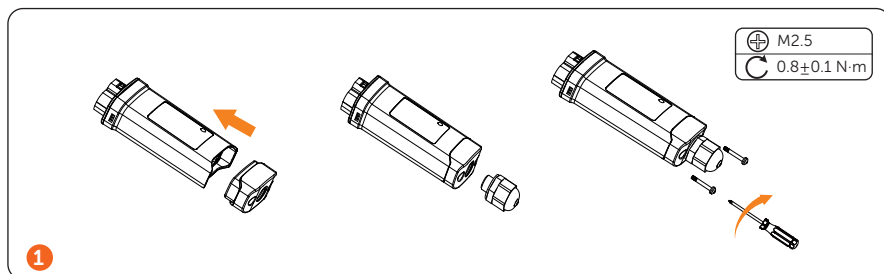

LAN Mode:

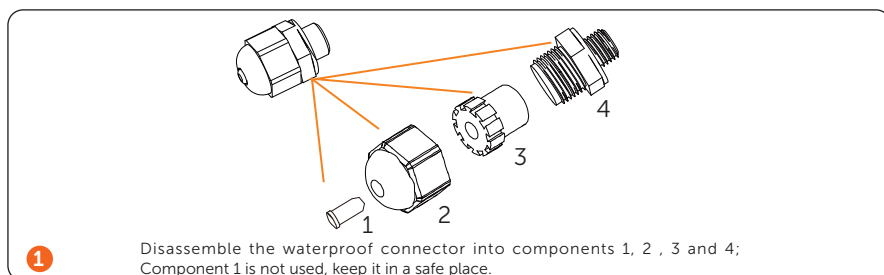

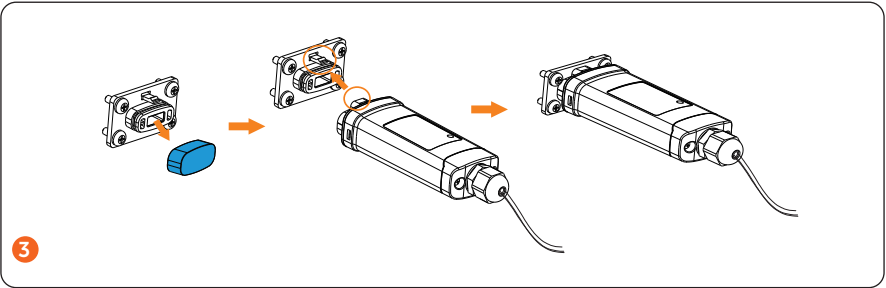
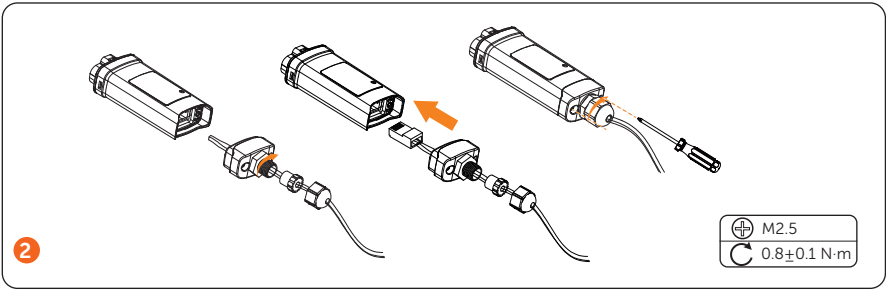



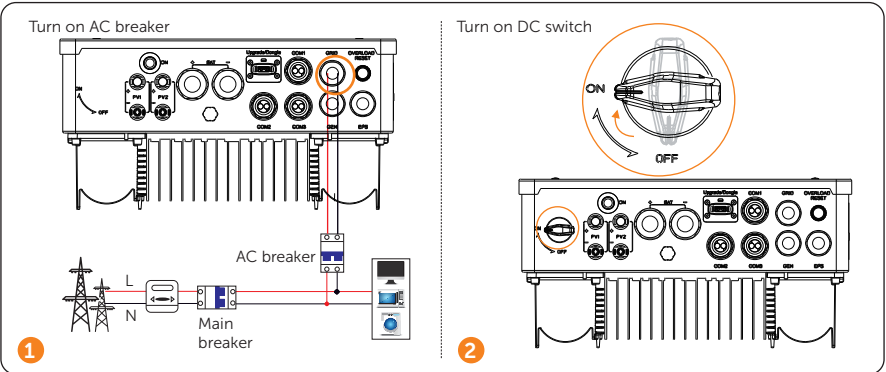

Power on the System / Schalten Sie das System ein / Mise sous tension du système / Encienda el sistema / Ligue o sistema / Het systeem inschakelen / Accensione del sistema / Włączanie systemu / Zapnutí systému / Slå på systemet / Pornire sistem / Включване на системата / Tænd for systemet / Ρεύμα στο σύστημα / Süsteemi sisselülitamine / Kytke järjestelmän virta päälle / Napajanje sustava / Rendszer áram alá helyezésé / Ijungti sistemą / Ieslēdziet sistēmu / Zapnite system / Vklópite sistem / Sistemini Gücü / Ligar o Sistema

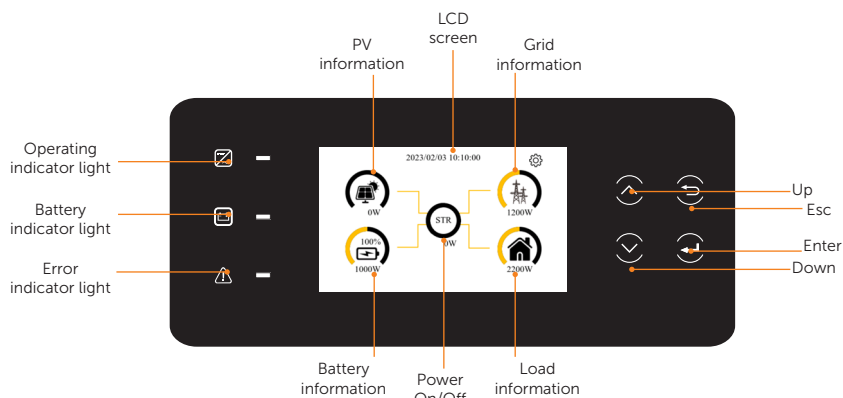

LCD Panel / LCD-Bildschirm / Panneau LCD / Panel LCD / Paineel de LCD / LCD-paneel / Pannelo LCD / Panel LCD / LCD panel / LCD-panel / Panou cu LCD / LCD панель / LCD-panel / Πάνελ LCD / LCD-paneel / LCD-paneeli / LCD ploča / LCD panel / LCD skýdas /LCD panelis / LCD Panel / LCD plošča/ LCD Panel / Paineel LCD



- While upgrading, the green, blue and red indicator lights will flash in turns, indicating that the upgrade is in progress.
- In error state, the fault message and error code will be displayed at the bottom of the LCD screen, please refer to corresponding solutions in the user manual.

LED indicator	Status	Definition
 Operating	Solid green	The inverter is in grid-connected operation state or off-grid operation state.
	Green blinking	The inverter is in the process of grid connection or off-grid.
	Light off	The inverter is in a fault or manual shutdown state.
 Battery	Solid blue	The battery is online and the voltage is normal.
	Light off	Low battery voltage or no battery.
 Error	Solid red	The inverter is in fault status.
	Red blinking	The inverter has alarm information.
	Light off	There are no faults and alarms in the inverter.

Key	Definition
Esc key	Exit from the current interface or function
Up key	Move the cursor to the upper part or increase the value
Down key	Move the cursor to the lower part or decrease the value
Enter key	Confirm the selection

General Setting / Allgemeine Einstellungen / Paramètres généraux / Configuración general / Definição Geral / Algemene instelling / Impostazione generale / Ustawienia ogólne / Obecné nastavení / Generell inställning / Setare general / Обща настройка / General indstilling / Γενική τοποθέτηση / Üldine seadistus / Yleisasetus / Orče postavke / Általános beállítás / Bendrasis nustatymas / Vispārīgs iestatījums / Všeobecné nastavenie / Splošna nastavitve / Genel Ayar / Configuração Geral

1 Set the Power On/Off. Tap the "v" on the screen or press the Enter button after completing the modification to save the setup.

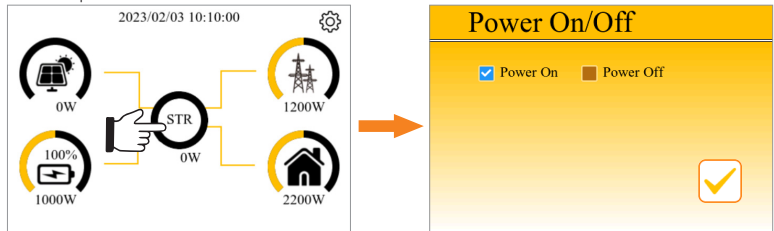

2 Tap the settings icon in the upper right corner to enter the main menu.

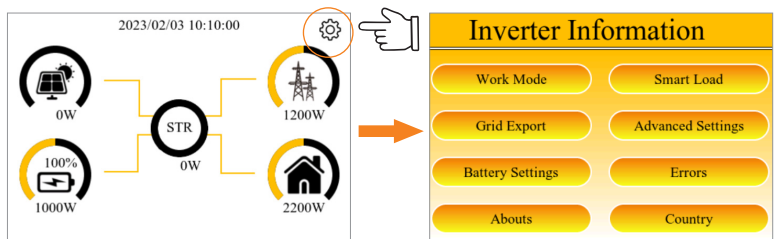

3 Set the basic settings including system time, date and language. The initial password is 0000 which should be changed for the consideration of account security.

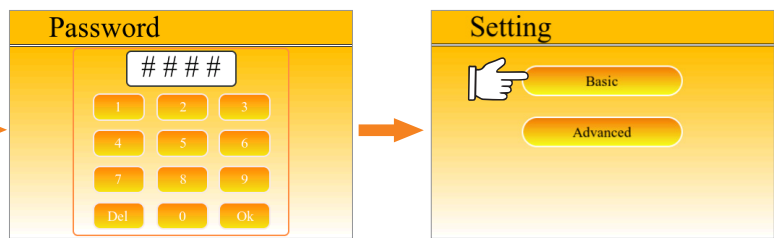
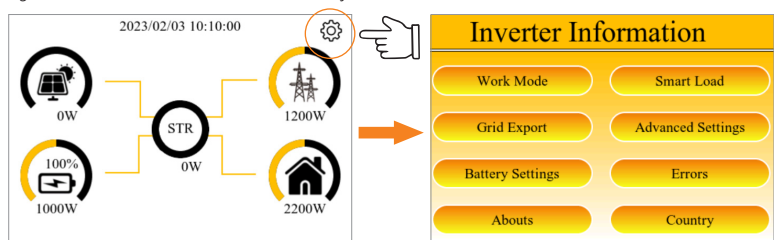

Basic Setting 1/2

Language English

Communication

RS485 Addr 1

RS485 Baud 4800

Date Time

2000 / 01 / 01 / 00 : 00

Mute Enable

Basic Setting 2/2

Reset Password Reset

Meter/CT Install State None

DI Function Set Disable

DO Function Set Disable

CT Sensitivity Level 1

Battery Sleep Enable

LCD Steady Bright Enable

4 Select the country. Please note that only when "Pakistan" is selected here will Pakistan's 4 modes be displayed in "Work Mode" and the "Basic Settings" interface will be different accordingly.

Inverter Information

Work Mode Smart Load

Grid Export Advanced Settings

Battery Settings Errors

Abouts Country

Country

INDIA

INDIA

VIETNAM

PAKISTAN

SOUTHAFRICA

UZBEKISTAN

Confirm

5 Select the work modes.

- Work modes for Pakistan:

Inverter Information

Work Mode Smart Load

Grid Export Advanced Settings

Battery Settings Errors

Abouts Country

Mode Settings

SUB SBU MKS Time of Use

Mode Settings

SUB SBU MKS Time of Use

Return To Utility Voltage 48.0 V

Return To Battery Voltage 52.0 V

Confirm

Mode Settings

SUB SBU MKS Time of Use

Low DC Cut-off Voltage 48.0 V

Confirm

Mode Settings

SUB SBU MKS Time of Use

- Work modes for other countries:

Inverter Information

Work Mode: Smart Load

Grid Export: Advanced Settings

Battery Settings: Errors

Abouts: Country

Mode Settings

Backup Self Consumption Time of Use

Mode Settings

Backup Self Consumption Time of Use

Return To Utility Voltage: V

Return To Battery Voltage: V

Confirm

Mode Settings

Backup Self Consumption Time of Use

When "Time Of Use" mode is selected, there will be two interface pages for setting the charging period and discharging period. You can switch between the two pages using the up and down buttons:

Time Of Use

Home load removed from Utility time periods

	Start	End
1	<input type="text" value="00"/> : <input type="text" value="00"/> : <input type="text" value="00"/>	<input type="text" value="00"/> : <input type="text" value="00"/> : <input type="text" value="00"/>
2	<input type="text" value="00"/> : <input type="text" value="00"/> : <input type="text" value="00"/>	<input type="text" value="00"/> : <input type="text" value="00"/> : <input type="text" value="00"/>
3	<input type="text" value="00"/> : <input type="text" value="00"/> : <input type="text" value="00"/>	<input type="text" value="00"/> : <input type="text" value="00"/> : <input type="text" value="00"/>

Battery Stop Discharge Voltage: V

Confirm

Time Of Use

Charge Period

	Start	End	Source
1	<input type="text" value="00"/> : <input type="text" value="00"/> : <input type="text" value="00"/>	<input type="text" value="00"/> : <input type="text" value="00"/> : <input type="text" value="00"/>	<input type="text" value="PV Only"/>
2	<input type="text" value="00"/> : <input type="text" value="00"/> : <input type="text" value="00"/>	<input type="text" value="00"/> : <input type="text" value="00"/> : <input type="text" value="00"/>	<input type="text" value="PV Only"/>
3	<input type="text" value="00"/> : <input type="text" value="00"/> : <input type="text" value="00"/>	<input type="text" value="00"/> : <input type="text" value="00"/> : <input type="text" value="00"/>	<input type="text" value="PV Only"/>

Confirm

- 6 Select the grid export. Here users can choose between feeding excess PV power into the grid or limiting it.

Inverter Information

Work Mode: Smart Load

Grid Export: Advanced Settings

Battery Settings: Errors

Abouts: Country

Grid Export

No Export

Export %

Max Utility Charge Current: A

Confirm

Wi-Fi Configuration / WLAN-Konfiguration / Configuration Wi-Fi / Configuración de wifi / Configuração de Wi-Fi/Wi-Fi-configuratie / Configurazione del Wi-Fi / Konfiguracja Wi-Fi / Konfigurace Wi-Fi / Wi-Fi-konfiguration / Configurare Wi-Fi / Wi-Fi конфигурация / WiFi-konfiguration / Ρυθμίσεις παραμέτρων Wi-Fi / Wi-Fi konfiguratsioon / Wi-Fi-kokoonpano / Konfiguracija Wi-Fi mreže / Wi-Fi konfiguráció / „Wi-Fi” konfiguracija / Wi-Fi konfigurācija / Konfigurácia Wi-Fi / Konfiguracija Wi-Fi / Wi-Fi Yapılandırması / Configuração Wi-Fi



1 Scan the QR code to download SolaXCloud App.

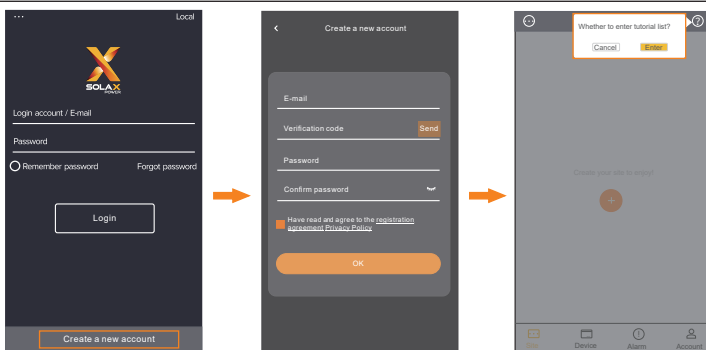

2 Create a new account and follow the tutorial on the SolaXCloud APP or the App guide at <https://www.solaxcloud.com/> to set the WiFi configuration.



Or scan the QR code to watch the WiFi configuration video on YouTube.

Technical Data / Technische Daten / Fiche technique / Datos técnicos / Dados Técnicos / Technische gegevens / Dati tecnici / Dane techniczne / Technické údaje / Techniska data / Date tehnice / Технически данни / Techniske data / Τεχνικά δεδομένα / Tehniskie podaci / Tehnički podaci / Műszaki adatok / Techniniai duomenys / Tehniskie dati / Technické údaje / Tehnični podatki / Teknik Bilgiler / Dados Técnicos

• DC input

Model	X1-HYB-3.0-LV	X1-HYB-3.7-LV	X1-HYB-4.0-LV	X1-HYB-4.6-LV	X1-HYB-5.0-LV	X1-HYB-6.0-LV
Max. PV array power [Wp]	4500	5500	6000	6900	7500	9000
Max. PV input voltage [V]	550					
Start output voltage[V]	110					
Nominal input voltage [V]	360					
MPPT voltage range[V]	80 ~ 520					
No. of MPPT/Strings per MPPT	2 (1/1)					
Max. input current[A]	16/16					
Max. short circuit current[A]	20/20					

• AC output/ input

Model	X1-HYB-3.0-LV	X1-HYB-3.7-LV	X1-HYB-4.0-LV	X1-HYB-4.6-LV	X1-HYB-5.0-LV	X1-HYB-6.0-LV
Nominal AC Output Current[A]	13	16	17.4	20	21.7	26.1
Nominal AC output power[W]	3000	3680	4000	4600	5000	6000
Max. AC output apparent power[VA]	3300	3680	4400	4600	5000	6000
Max. AC output current [A]	15	16	20	20.9 (Germany 20)	22.7	27.3
Max. AC input apparent power [VA]	6000	7360	8000	9200	9200	9200
Max. AC input current [A]	26.1	32	34.8	40	40	40
Nominal voltage [V], frequency [Hz]	220/230/240, 50/60					
Displacement power factor	0.8 leading ~ 0.8 lagging					
THDi (rated power) [%]	<3					
AC Connection	L/N/PE					
DC Disconnection Switch	Optional					

• EPS output

Model	X1-HYB-3.0-LV	X1-HYB-3.7-LV	X1-HYB-4.0-LV	X1-HYB-4.6-LV	X1-HYB-5.0-LV	X1-HYB-6.0-LV
Nominal output power [W]	3000	3680	4000	4600	5000	6000
Peak apparent power[VA] ¹	2 times of nominal, 10s					
Nominal Output Current[A]	13	16	17.4	20	21.7	26.1
Nominal voltage [V], frequency [Hz]	230, 50/60					
Switch Time[ms]	<10					

* "1" Depend on PV and battery capacity.

• Battery data

Model	X1-HYB-3.0-LV	X1-HYB-3.7-LV	X1-HYB-4.0-LV	X1-HYB-4.6-LV	X1-HYB-5.0-LV	X1-HYB-6.0-LV
Battery type	Lithium/Lead-Acid					
Battery voltage range [V]	40~60					
Nominal Battery Voltage[V]	48					
Max. Charging Voltage[V]	<=60 (Adjustable)					
Max. Charging/Discharging Current[A]	75			120		
Charging Strategy for Li-Ion Battery	Self-adaption to BMS					
Charging Strategy for Lead-Acid Battery	3 stages curve					
Temperature Sensor	Optional					

- System data

Model	X1-HYB-3.0-LV	X1-HYB-3.7-LV	X1-HYB-4.0-LV	X1-HYB-4.6-LV	X1-HYB-5.0-LV	X1-HYB-6.0-LV
MPPT Efficiency	>99.9%					
Max. efficiency [%]	97.6					
Euro. efficiency [%]	97.0					
Battery charge/discharge efficiency [%] ²	96.0/95.0					

* ² PV to BAT Max. efficiency 96.0%, BAT to AC Max. efficiency 95.0%.

- Protection device

Model	X1-HYB-3.0-LV	X1-HYB-3.7-LV	X1-HYB-4.0-LV	X1-HYB-4.6-LV	X1-HYB-5.0-LV	X1-HYB-6.0-LV
Anti-Islanding Protection	Yes					
PV String Input Reverse Polarity Protection	Yes					
Insulation Resistor Detection	Yes					
Residual Current Monitoring Unit	Yes					
Output Over Current Protection	Yes					
Output Short Protection	Yes					
Output Over Voltage Protection	Yes					
Surge Protection	AC Type III/DC Type III					
Battery Terminal Temp Protection	Yes					

- Power consumption & Environment limit

Model	X1-HYB-3.0-LV	X1-HYB-3.7-LV	X1-HYB-4.0-LV	X1-HYB-4.6-LV	X1-HYB-5.0-LV	X1-HYB-6.0-LV
Self Consumption(night) [W]	Standby < 40, Shutdown < 10					
Degree of protection	IP65					
Operating temperature range[°C]	-25 ~ +60 (derating above +45)					
Relative humidity [%]	0 ~ 100 (condensing)					
Max. operation altitude [m]	<3000					
Storage Temperature[°C]	-25 ~ +70					
Noise Emission(typical)[dB]	<39				<50	

- General data

Model	X1-HYB-3.0-LV	X1-HYB-3.7-LV	X1-HYB-4.0-LV	X1-HYB-4.6-LV	X1-HYB-5.0-LV	X1-HYB-6.0-LV
Dimensions(WxHxD) [mm]	397x490x201					
Net weight [kg]	16.5				17.3	
Cooling concept	Natural				Smart cooling	
Topology	Transformerless for PV Side/HF for battery Side					
HMI Interface	LED+LCD					
Communication interfaces	CAN, RS485, CT, Meter, WiFi, LAN, 4G (Optional), USB , NTC, wifi+lan, wifi+4G					

Contact Information



UNITED KINGDOM



Unit C-D Riversdale House, Riversdale
Road, Atherstone, CV9 1FA



+44 (0) 2476 586 998



service.uk@solaxpower.com



AUSTRALIA



21 Nicholas Dr, Dandenong South VIC 3175



+61 1300 476 529



service@solaxpower.com



TURKEY



Fevzi Çakmak mah. aslim cd. no 88 A
Karatay / Konya / Türkiye



+90 530 252 02 19



service.tr@solaxpower.com



GERMANY



Am Tullnaupark 8, 90402 Nürnberg,
Germany



+49 (0) 6142 4091 664



service.eu@solaxpower.com



service.dach@solaxpower.com



USA



3780 Kilroy Airport Way, Suite 200, Long
Beach, CA, US 90806



+1 (408) 690 9464



info@solaxpower.com



NETHERLANDS



Twekkeler-Es 15 7547 ST Enschede



+31 (0) 8527 37932



service.eu@solaxpower.com



service.bnl@solaxpower.com



POLAND



WARSAW AL. JANA P. II 27. POST



+48 662 430 292



service.pl@solaxpower.com



SPAIN



+34 9373 79607



tecnico@solaxpower.com



ITALY



+39 011 19800998



support@solaxpower.it



BRAZIL



+55 (34) 9667 0319



info@solaxpower.com



PAKISTAN



service.pk@solaxpower.com



SOUTH AFRICA



service.za@solaxpower.com

Warranty Registration Form



For Customer (Compulsory)

Name _____ Country _____
Phone Number _____ Email _____
Address _____
State _____ Zip Code _____
Product Serial Number _____
Date of Commissioning _____
Installation Company Name _____
Installer Name _____ Electrician License No. _____

For Installer

Module (If Any)

Module Brand _____
Module Size(W) _____
Number of String _____ Number of Panel Per String _____

Battery (If Any)

Battery Type _____
Brand _____
Number of Battery Attached _____
Date of Delivery _____ Signature _____

Please visit our warranty website: <https://www.solaxcloud.com/#/warranty> or use your mobile phone to scan the QR code to complete the online warranty registration.



For more detailed warranty terms, please visit SolaX official website: www.solaxpower.com to check it.





SolaX Power Network Technology (Zhejiang) Co., Ltd.

Add.: No. 288, Shizhu Road, Tonglu Economic Development Zone,
Tonglu City, Zhejiang Province, 310000 P. R. CHINA

Tel.: +86 (0) 571 5626 0011

E-mail: info@solaxpower.com / service@solaxpower.com

