



# X1-Fit-G4

**3.7 kW / 5.0 kW / 6.0kW / 7.5kW**

## **Installation Manual**

Version 1.0

[www.solaxpower.com](http://www.solaxpower.com)



eManual in the QR code or at <http://hs.solaxpower.com/>



# Table of Contents

---











Safety.....	1
Sicherheit.....	3
Sécurité.....	5
Seguridad.....	7
Segurança.....	9
Veiligheid.....	11
Sicurezza.....	13
Bezpieczeństwo.....	15
Bezpečnost.....	17
Säkerhet.....	19
Siguranță.....	21
Безопасност.....	23
Sikkerhed.....	25
Ασφάλεια.....	27
Ohutus.....	29
Turvallisuus.....	31
Sigurnost.....	33
Biztonság.....	35
Sauga.....	37
Drošība.....	39
Bezpečnosť.....	41
Varnost.....	43
Güvenlik.....	45
Segurança.....	47
ةم ال سل ا.....	49

תוחיטב.....	51
Installation.....	53
For Customer (Compulsory) .....	79
For Installer .....	79

## General Notice

1. Contents may be periodically updated or revised. SolaX reserves the right to make improvements or changes in the product(s) and the program(s) described in this manual without the prior notice.
2. The installation, maintenance and grid-related setting can only be performed by qualified personnel who:
  - Are licensed and/or satisfy state and local jurisdiction regulations;
  - Have good knowledge of this manual and other related documents.
3. Before installing the device, carefully read, fully understand and strictly follow the detailed instruction of the user manual and other related regulations. SolaX shall not be liable for any consequences caused by the violation of the storage, transportation, installation, and operation regulations specified in this document and the user manual.
4. Use insulated tools when installing the device. Individual protective tools must be worn during installation, electrical connection and maintenance.
5. Please visit the website [www.solaxpower.com](http://www.solaxpower.com) of SolaX for more information.

## Descriptions of Labels

	CE mark of conformity		TUV certification
	RCM mark of conformity		Caution, hot surface
	Additional grounding point		Caution, risk of danger
	Caution, risk of electric shock		Do not dispose of the inverter together with household waste.
	Read the enclosed documentations		
	Do not operate this inverter until it is isolated from mains and on-site PV generation suppliers.		
	Danger of high voltage. Do not touch live parts for 5 minutes after disconnection from the power sources.		

 **DANGER!****Lethal danger from electrical shock due to the inverter**

- Only operate the inverter when it is technically faultless. Otherwise, electric shock or fire may occur.
- Do not open the enclosure in any case without authorization from SolaX. Unauthorized opening will void the warranty and cause lethal danger or serious injury due to electric shock.

 **WARNING!****Risk of personnel injury or inverter damage**

- During operation, do not touch any parts other than DC switch and LCD panel.
- Never connect or disconnect the AC and DC connectors when the inverter is running.
- Turn off the AC and DC power and disconnect them from the inverter, wait for 5 minutes to fully discharge the voltage before attempting any maintenance, cleaning or working on any circuits connected.
- Make sure that the input DC voltage  $\leq$  Maximum DC input voltage of the inverter. Overvoltage may cause permanent damage to the inverter, which is NOT covered by the warranty.

 **CAUTION!**

- Keep children away from the inverter.
- Pay attention to the weight of the inverter. Personal injuries may be caused if not handled properly.











**NOTICE!**

- If an external RCD is required by local regulations, check which type of RCD is required for relevant electric codes. It is recommended to use a Type-A RCD with the value of 300 mA.
- All the product labels and nameplate on the inverter shall be maintained clearly visible.

## Allgemeiner Hinweis

1. Inhalt kann regelmäßig aktualisiert oder überarbeitet werden. SolaX behält sich das Recht vor, Verbesserungen oder Änderungen an dem/den in diesem Handbuch beschriebenen Produkt(en) und Programm(en) ohne vorherige Ankündigung vorzunehmen.
2. Die Installation, Wartung und Netz-bezogene Einstellung darf nur von qualifiziertem Personal durchgeführt werden, das:
  - als solche zugelassen sind und/oder die Vorschriften der staatlichen und lokalen Gesetzgebung erfüllen;
  - gute Kenntnisse dieses Handbuchs und anderer damit zusammenhängender Dokumente haben.
3. Lesen Sie vor der Installation des Geräts die ausführlichen Anweisungen des Benutzerhandbuchs und anderer damit zusammenhängender Vorschriften sorgfältig durch, machen Sie sich mit ihnen vertraut und befolgen Sie sie genau. SolaX haftet nicht für Folgen, die durch die Verletzung der in diesem Dokument und im Benutzerhandbuch angegebenen Lager-, Transport-, Installations- und Betriebsvorschriften entstehen.
4. Benutzen Sie bei der Installation des Geräts isolierte Werkzeuge. Bei der Installation, dem elektrischen Anschluss und der Wartung muss individuelle Schutzausrüstung getragen werden.
5. Besuchen Sie bitte die Website [www.solaxpower.com](http://www.solaxpower.com) von SolaX für weitere Informationen.

## Beschreibungen der Etiketten

	CE-Kennzeichnung		TÜV-Zertifikat
	RCM-Zeichen		Vorsicht, heiße Oberfläche
	Zusätzlicher Erdungspunkt		Vorsicht, Gefahrenrisiko
	Vorsicht, Stromschlaggefahr		Entsorgen Sie den Wechselrichter nicht mit dem Hausmüll
	Lesen Sie die beigelegten Dokumente		
	Betreiben Sie diesen Wechselrichter erst, wenn er vom Stromnetz und von den PV-Erzeugern vor Ort getrennt ist.		
	Hochspannungsgefahr. Berühren Sie keine stromführenden Teile für 5 Minuten nach der Trennung von den Stromquellen.		

 **GEFAHR!****Tödliche Gefahr durch Stromschlag durch den Wechselrichter**

- Betreiben Sie den Wechselrichter nur, wenn er technisch einwandfrei ist. Andernfalls besteht Stromschlag- oder Brandgefahr;
- Öffnen Sie das Gehäuse auf keinen Fall ohne Genehmigung von SolaX. Eigenmächtiges Öffnen führt zum Verlust der Garantie und kann zu tödlichen Gefahren oder schweren Verletzungen durch Stromschlag führen.

 **WARNUNG!****Gefahr von Personenschäden oder Beschädigung des Wechselrichters**

- Berühren Sie während des Betriebs keine anderen Teile als den Gleichstrom-Schalter und den LCD-Bildschirm.
- Verbinden oder trennen Sie niemals die AC- und DC-Verbindungen, wenn der Wechselrichter in Betrieb ist.
- Schalten Sie die Wechsel- und Gleichstromversorgung aus und trennen Sie sie vom Wechselrichter, warten Sie 5 Minuten, um die Spannung vollständig zu entladen, bevor Sie Wartungs- oder Reinigungsarbeiten durchführen oder an den angeschlossenen Stromkreisen arbeiten.
- Prüfen Sie, ob die Eingangs-Gleichspannung  $\leq$  der maximalen Eingangsspannung des Wechselrichters beträgt. Eine Überspannung kann zu dauerhaften Schäden am Wechselrichter führen, die NICHT durch die Garantie abgedeckt sind.

 **VORSICHT!**

- Halten Sie Kinder vom Wechselrichter fern.
- Achten Sie auf das Gewicht des Wechselrichters. Bei unsachgemäßer Handhabung kann es zu Personenschäden kommen.

**HINWEIS!**











- Wenn ein externer FI-Schutzschalter gemäß den örtlichen Vorschriften erforderlich ist, prüfen Sie, welche Art von FI-Schutzschalter gemäß den einschlägigen Elektrovorschriften erforderlich ist. Es wird empfohlen, einen FI-Schutzschalter vom Typ A mit einem Wert von 300 mA zu benutzen.
- Alle Produktetiketten und das Typenschild des Wechselrichters müssen gut sichtbar bleiben.



## Avis général

1. Le contenu peut être périodiquement mis à jour ou révisé. SolaX se réserve le droit d'apporter des améliorations ou des modifications au(x) produit(s) et au(x) programme(s) décrit(s) dans ce manuel sans préavis.
2. L'installation, la maintenance et le réglage lié au réseau ne peuvent être effectués que par du personnel qualifié qui:
  - sont agréés et/ou satisfont aux exigences de la réglementation nationale et locale ;
  - ont une bonne connaissance de ce manuel et des autres documents connexes.
3. Avant d'installer l'appareil, lisez attentivement, comprenez parfaitement et suivez strictement les instructions détaillées du manuel d'utilisation et d'autres réglementations connexes. SolaX ne sera pas responsable des conséquences causées par la violation de la réglementation concernant le stockage, le transport, l'installation et l'exploitation spécifiées dans ce document et le manuel d'utilisation.
4. Utiliser des outils isolés lors de l'installation de l'appareil. Des outils de protection individuels doivent être portés lors de l'installation, du raccordement électrique et de la maintenance.
5. Veuillez visiter le site Web [www.solaxpower.com](http://www.solaxpower.com) de SolaX pour obtenir de plus amples informations.

## Descriptions des étiquettes

	Marquage CE de conformité		Homologation TÜV
	Marquage RCM de conformité		Attention, surface chaude
	Point de mise à la terre supplémentaire		Attention, risque de danger
	Attention, risque de choc électrique		Ne pas jeter l'onduleur avec les ordures ménagères
	Lire la documentation jointe		
	Ne pas faire fonctionner cet onduleur tant qu'il n'est pas isolé du secteur et des fournisseurs de production PV sur site.		
	Risque de haute tension. Ne pas toucher pas les pièces sous tension avant un délai de 5 minutes après la déconnexion des sources d'alimentation.		

 **DANGER!****Danger de mort par choc électrique dû à l'onduleur**

- N'exploitez l'onduleur que s'il est techniquement irréprochable. Sinon, un choc électrique ou un incendie pourrait se produire.
- Ne jamais ouvrir le boîtier sans l'autorisation de SolaX. L'ouverture non autorisée annulera la garantie et peut entraîner un danger mortel ou des blessures graves par choc électrique.

 **AVERTISSEMENT!****Risque de blessures corporelles ou de dommages à l'onduleur**

- Pendant le fonctionnement, ne touchez aucune pièce autre que l'interrupteur CC et le panneau LCD.
- Ne jamais brancher ni débrancher les fiches CA et CC lorsque l'onduleur fonctionne.
- Coupez l'alimentation CA et CC et déconnectez-les de l'onduleur, attendez 5 minutes pour décharger complètement la tension avant de tenter toute maintenance, nettoyage ou travail sur les circuits connectés.
- S'assurer que la tension d'entrée CC soit  $\leq$  à la tension d'entrée CC nominale maximale de l'onduleur. Une surtension peut causer des dommages permanents à l'onduleur, ce qui n'est PAS couvert par la garantie.

 **ATTENTION!**

- Tenir les enfants éloignés de l'onduleur.
- Prêter attention au poids de l'onduleur. Des blessures personnelles peuvent être causées si le produit n'est pas manipulé correctement.













**PRUDENCE!**

- Si un disjoncteur externe est requis par les réglementations locales, vérifiez quel type de disjoncteur est requis pour les codes électriques pertinents. Il est recommandé d'utiliser un disjoncteur de type A avec une valeur de 300 mA.
- Toutes les étiquettes de produit et la plaque signalétique de l'onduleur doivent rester clairement visibles.

## Aviso general

1. Los contenidos pueden actualizarse o revisarse periódicamente. SolaX se reserva el derecho de realizar cambios o mejoras en los productos y programas descritos en el presente manual sin previo aviso.
2. La instalación, el mantenimiento y la configuración relacionada con la red solo pueden ser realizados por personal cualificado que:
  - Tienen licencia o cumplen con las regulaciones de la jurisdicción estatal y local.
  - Tienen un buen conocimiento del presente manual y otros documentos relacionados.
3. Antes de instalar el dispositivo, lea con atención, comprenda bien y siga estrictamente las instrucciones detalladas del manual de usuario y otras normas relacionadas. SolaX no será responsable de las consecuencias causadas por el incumplimiento de las normas de almacenamiento, transporte, instalación y funcionamiento especificadas en este documento y el manual de usuario.
4. Utilice herramientas aisladas cuando instale el dispositivo. Se deben usar herramientas de protección individual durante la instalación, la conexión eléctrica y el mantenimiento.
5. Para obtener más información, visite el sitio web de SolaX [www.solaxpower.com](http://www.solaxpower.com).

## Descripciones de etiquetas

	Marcado CE de conformidad		Certificación TÜV
	Marcado RCM de conformidad		Precaución: superficie caliente
	Punto de conexión a tierra adicional		Precaución: riesgo de peligro
	Precaución: riesgo de descarga eléctrica		No deseche el inversor con la basura doméstica.
	Lea la documentación anexa		
	No utilice este inversor hasta que esté aislado de la red y equipo de suministro FV in situ.		
	Peligro de alto voltaje.		
	No toque las partes activas durante los 5 minutos posteriores a la desconexión de las fuentes de alimentación.		

**⚠ PELIGRO!****Peligro de muerte por descarga eléctrica a causa del inversor**

- Utilice el inversor únicamente cuando esté perfecto desde el punto de vista técnico. De lo contrario, podría producirse una descarga eléctrica o un incendio.
- En ningún caso, abra la caja sin autorización de SolaX. La apertura no autorizada anulará la garantía y puede causar peligro de muerte o lesiones graves por descarga eléctrica.

**⚠ ADVERTENCIA!****Riesgo de lesiones personales o daños en el inversor**

- Durante el funcionamiento, no toque ninguna pieza que no sea el interruptor de CC y el panel LCD .
- Nunca conecte o desconecte los conectores de CA y CC cuando el inversor esté en funcionamiento.
- Antes de realizar cualquier tarea de mantenimiento, limpieza o trabajo en los circuitos conectados, Apague la alimentación de CA y CC, y desconéctelas del inversor, espere 5 minutos para que se descargue completamente la tensión.
- Asegúrese de que la tensión de CC de entrada  $\leq$  Tensión nominal máxima de entrada de CC del inversor. La sobretensión puede provocar daños permanentes en el inversor, que NO están cubiertos por la garantía.

**⚠ PRECAUCIÓN!**

- Mantenga a los niños alejados del inversor
- Preste atención al peso del inversor. Si no se maneja adecuadamente, se pueden provocar lesiones personales.













**AVISO!**

- Si la legislación local exige un RCD externo, compruebe qué tipo de RCD es necesario para el código eléctrico pertinente. Se recomienda utilizar un RCD de tipo A con un valor de 300 mA.
- Todas las etiquetas del producto y la placa de características del inversor deberán mantenerse claramente visibles.

## Aviso geral

- O conteúdo pode ser atualizado ou revisto periodicamente. A SolaX reserva-se ao direito de fazer melhorias ou alterações no(s) produto(s) e no(s) programa(s) descrito(s) neste manual sem aviso prévio.
- A instalação, manutenção e configuração relacionada com a rede só podem ser executadas por pessoal qualificado que:
  - São licenciados e/ou atendem aos regulamentos da jurisdição estadual e local;
  - Têm um bom conhecimento deste manual e de outros documentos relacionados.
- Antes de instalar o dispositivo, leia atentamente, compreenda completamente e siga rigorosamente as instruções detalhadas do manual do utilizador e outros regulamentos relacionados. A SolaX não se responsabiliza por quaisquer consequências causadas pela violação dos regulamentos de armazenamento, transporte, instalação e operação especificados neste documento e no manual do utilizador.
- Utilize ferramentas com isolamento ao instalar o dispositivo. Os equipamentos de proteção individual devem ser usados durante a instalação, ligação elétrica e manutenção.
- Visite o site [www.solaxpower.com](http://www.solaxpower.com) da SolaX para obter mais informações.

## Descrições de rótulos

	Marca CE de conformidade		Certificação TUV
	Marca RCM de conformidade		Cuidado! Superfície quente
	Ponto de ligação à terra adicional		Cuidado! Risco de perigo
	Cuidado! Risco de choque elétrico		Não descarte o inversor junto com o lixo doméstico.
	Leia a documentação incluída		
	Não opere este inversor até que ele esteja isolado da rede elétrica e dos painéis fotovoltaicos geradores de energia.		
	Perigo de alta tensão.		
	Não toque nas partes energizadas por 5 minutos após a desconexão das fontes de alimentação.		

 PERIGO!

**Perigo letal de choque elétrico devido ao inversor**

- Opere o inversor somente quando ele estiver tecnicamente sem falhas. Caso contrário, pode ocorrer choque elétrico ou incêndio.
- Não abra o compartimento em nenhum caso sem autorização da SolaX. A abertura não autorizada anulará a garantia e pode causar perigo letal ou ferimentos graves devido a choque elétrico.

 AVISO!

**Risco de ferimentos pessoais ou danos no inversor**

- Durante a operação, não toque em nenhuma peça que não seja o interruptor CC e o painel LCD.
- Nunca conecte ou desconecte os conectores CA e CC quando o inversor estiver em funcionamento.
- Desligue a alimentação CA e CC e desconecte-as do inversor, aguarde 5 minutos para descarregar totalmente a tensão antes de realizar qualquer manutenção, limpeza ou trabalho em qualquer circuito ligado.
- Certifique-se de que a tensão CC de entrada  $\leq$  Tensão de entrada CC máxima nominal do inversor. A sobretensão pode causar danos permanentes ao inversor, que NÃO são cobertos pela garantia.

 CUIDADO!

- Mantenha as crianças longe do inversor.
- Preste atenção ao peso do inversor. Ferimentos pessoais podem ser causados se o inversor não for manuseado adequadamente.

PONTA!

- Se um RCD externo for obrigatório perante a legislação local, verifique que tipo de RCD é exigido para os códigos de eletricidade relevantes. Recomenda-se usar um RCD Tipo A com o valor de 300 mA.
- Todas as etiquetas do produto e a placa de identificação no inversor devem ser mantidas claramente visíveis.

## Algemene kennisgeving

1. De inhoud kan periodiek worden bijgewerkt of herzien. SolaX behoudt zich het recht voor om zonder voorafgaande kennisgeving verbeteringen of wijzigingen aan te brengen in de producten en de programma's die worden beschreven in deze handleiding.
2. De installatie, het onderhoud en de aan het net gerelateerde instellingen, mogen uitsluitend worden uitgevoerd door gekwalificeerd personeel dat:
  - Gecertificeerd zijn en/of voldoen aan de nationale en lokale regelgeving;
  - Goede kennis hebben van deze handleiding en andere gerelateerde documenten.
3. Voordat u het toestel installeert, moet u de gedetailleerde instructies in de gebruikershandleiding en andere verwante regelgeving zorgvuldig lezen, volledig begrijpen en strikt opvolgen. SolaX is niet aansprakelijk voor de gevolgen van het niet naleven van de voorschriften voor opslag, transport, installatie en gebruik die in dit document en in de gebruikershandleiding worden vermeld.
4. Gebruik geïsoleerd gereedschap bij het installeren van het apparaat. Tijdens de installatie, elektrische aansluiting en onderhoud moeten individuele beschermingsmiddelen worden gedragen.
5. Ga naar de website [www.solaxpower.com](http://www.solaxpower.com) van SolaX voor meer informatie.

## Beschrijving van de etiketten

	CE-markering van overeenstemming		TUV-certificering
	RCM-markering van overeenstemming		Opgelet, heet oppervlak
	Extra aardingspunt		Opgelet, risico op gevaar
	Opgelet, risico op elektrische schokken		Gooi de omvormer niet samen met het huisvuil weg.
	Lees de bijgesloten documentatie		
	Gebruik deze omvormer niet totdat deze is geïsoleerd van het lichtnet en PV-generatoren ter plaatse.		
	Hoogspanningsgevaar. Raak na het loskoppelen van de stroombronnen gedurende 5 minuten geen spanningvoerende delen aan.		

 **GEVAAR!****Levensgevaar door elektrische schok vanwege de omvormer**

- Gebruik de omvormer alleen als deze technisch in orde is. Als dit niet het geval is, kunnen er elektrische schokken of brand ontstaan.
- Open de behuizing in geen geval zonder toestemming van SolaX. Het zonder toestemming openen van de behuizing doet de garantie vervallen en kan levensgevaar of ernstig letsel als gevolg van elektrische schokken veroorzaken.

 **WAARSCHUWING!****Risico op persoonlijk letsel of beschadiging van de omvormer**

- Raak tijdens bedrijf geen andere onderdelen dan de DC-schakelaar en het LCD-paneel aan.
- Als de omvormer in bedrijf is, mogen de AC- en DC-connectoren nooit worden aangesloten of losgekoppeld.
- Schakel de AC- en DC-voeding uit en koppel ze los van de omvormer, wacht 5 minuten om de spanning volledig te ontladen alvorens onderhoud uit te voeren, de omvormer te reinigen of werkzaamheden uit te voeren aan aangesloten circuits.
- Zorg ervoor dat de DC-ingangsspanning  $\leq$  maximale nominale DC-ingangsspanning van de omvormer. Overspanning kan permanente schade aan de omvormer veroorzaken. Dit wordt NIET gedekt door de garantie.

 **ATTENTIE!**

- Houd kinderen uit de buurt van de omvormer.
- Let op het gewicht van de omvormer. Er kan persoonlijk letsel ontstaan als de omvormer niet juist wordt behandeld.

**ADVIES!**











- Als een externe RCD (aardlekschakelaar) vereist is door de lokale regelgeving, controleer dan welk type RCD vereist is voor relevante elektrische codes. Het wordt aanbevolen om een Type-A RCD met een waarde van 300 mA te gebruiken.
- Alle productlabels en naamplaatjes op de omvormer moeten duidelijk zichtbaar blijven.



## Avvisi generali

1. Il contenuto può essere soggetto periodicamente ad aggiornamenti o revisioni. SolaX si riserva il diritto di apportare migliorie o modifiche al(i) prodotto(i) e al(i) programma(i) descritti in questo manuale senza alcun preavviso.
2. L'installazione, la manutenzione e l'impostazione relativa alla rete possono essere eseguite esclusivamente da addetti qualificati, i quali:
  - sono in possesso di un'autorizzazione e/o agiscono nel rispetto delle normative nazionali e locali;
  - hanno una conoscenza approfondita di questo manuale o di altri documenti correlati.
3. Prima di installare il dispositivo, leggere attentamente, comprendere appieno e seguire scrupolosamente le istruzioni dettagliate del manuale dell'utente e le altre normative correlate. SolaX non sarà ritenuta responsabile per conseguenze che risultino dal mancato rispetto delle norme di conservazione, trasporto, installazione e funzionamento specificate in questo documento e nel manuale dell'utente.
4. Utilizzare utensili isolati nel corso dell'installazione del dispositivo. È necessario indossare dispositivi di protezione individuale durante gli interventi finalizzati all'installazione, al collegamento elettrico e alla manutenzione.
5. Si prega di visitare il sito web di SolaX [www.solaxpower.com](http://www.solaxpower.com) per maggiori informazioni.

## Descrizioni delle etichette

	Marchio di conformità CE		Certificazione TÜV
	Marchio di conformità RCM		Attenzione, superficie ad alta temperatura
	Punto di messa a terra aggiuntivo		Attenzione, rischio di pericolo
	Attenzione, rischio di folgorazione		Non smaltire l'inverter come un normale rifiuto domestico.
	Leggere la documentazione in allegato		
	Non mettere in funzione l'inverter finché non è stato isolato dalla rete e dai generatori FV in loco.		
	Pericolo di alta tensione. Non toccare parti sotto tensione nei cinque minuti successivi all'aver scollegato le fonti di alimentazione.		

 **PERICOLO!****Pericolo di morte per scosse elettriche dovute all'inverter**

- Utilizzare l'inverter solo quando è tecnicamente privo di difetti. In caso contrario, potrebbe verificarsi il rischio di folgorazione o incendio.
- Non aprire l'involucro dell'inverter in alcuna circostanza senza l'autorizzazione di SolaX. L'aprirlo in assenza di autorizzazione invaliderà la garanzia e può causare pericolo di morte o lesioni gravi per folgorazione.

 **AVVERTENZA!****Rischio di lesioni personali o danni all'inverter**

- Durante il funzionamento, non toccare parti diverse dall'interruttore CC e dal pannello LCD.
- Non collegare o scollegare connettori CA e CC quando l'inverter è in funzione.
- Spegnerne l'alimentazione CA e CC, quindi scollegarli dall'inverter, attendere cinque minuti perché la tensione si scarichi completamente, prima di procedere alla manutenzione, alla pulizia o ad interventi sui circuiti collegati.
- Assicurarsi che la tensione in ingresso CC sia pari o inferiore al valore nominale massimo dell'inverter. Una sovratensione potrebbe causare danni permanenti all'inverter non coperti da garanzia.

 **ATTENZIONE!**

- Tenere l'inverter lontano dalla portata dei bambini.
- Tenere in considerazione il peso dell'inverter; se non viene maneggiato adeguatamente, potrebbe causare lesioni personali.











**AVVISO!**

- Se i regolamenti locali obbligano all'utilizzo di un RCD esterno, verificare quale sia il tipo richiesto dal codice elettrico pertinente. Si consiglia l'utilizzo di un RCD di tipo A con valori di corrente pari a 300 mA.
- Tutte le etichette e la targhetta riportate sull'inverter devono essere mantenute in modo da essere perfettamente visibili.

## Uwaga ogólna

1. Treść może być co pewien czas aktualizowana lub zmieniana. Firma SolaX zastrzega sobie prawo do wprowadzania ulepszeń lub zmian w produktach i programach opisanych w niniejszej instrukcji bez uprzedniego powiadomienia.
2. Instalację, konserwację i konfigurację urządzeń związanych z siecią mogą przeprowadzać wyłącznie wykwalifikowani pracownicy, którzy:
  - Posiadają odpowiednią licencję i/lub spełniają wymogi określone w przepisach krajowych i lokalnych;
  - Są obeznani z treścią niniejszej instrukcji i innych powiązanych dokumentów.
3. Przed zainstalowaniem urządzenia należy uważnie przeczytać i w pełni zrozumieć szczegółowe instrukcje określone w podręczniku użytkownika oraz innych powiązanych regulacjach i ściśle się do nich stosować. Firma SolaX nie ponosi odpowiedzialności za jakiegokolwiek skutki spowodowane naruszeniem zasad przechowywania, transportu, instalacji i obsługi określonych w niniejszym dokumencie oraz instrukcji obsługi.
4. Podczas instalowania urządzenia należy korzystać z izolowanych narzędzi. Podczas instalacji, podłączenia elektrycznego i konserwacji należy nosić indywidualne środki ochrony.
5. Więcej informacji można znaleźć na stronie internetowej firmy SolaX: [www.solaxpower.com](http://www.solaxpower.com).

## Opisy etykiet

	Znak zgodności CE		Certyfikat TUV
	Znak zgodności RCM		Ostrożnie, gorąca powierzchnia
	Dodatkowy punkt uziemienia		Ostrożnie, ryzyko niebezpieczeństwa
	Ostrożnie, ryzyko porażenia prądem		Nie należy wyrzucać falownika razem z odpadami domowymi.
	Zapoznaj się z załączoną dokumentacją		
	Nie należy używać tego falownika, dopóki nie zostanie on odizolowany od sieci zasilającej i dostawców energii fotowoltaicznej na miejscu.		
	Niebezpieczeństwo związane z wysokim napięciem. Nie wolno dotykać części pod napięciem przez 5 minut od momentu odłączenia od źródła zasilania.		

## NIEBEZPIECZEŃSTWO!

### Śmiertelne niebezpieczeństwo porażenia prądem z falownika

- Falownik należy obsługiwać wyłącznie, gdy jest w pełni sprawny technicznie. W przeciwnym razie może dojść do porażenia prądem lub pożaru.
- W żadnym wypadku nie wolno otwierać obudowy bez upoważnienia firmy SolaX. Nieuprawnione otwarcie spowoduje utratę gwarancji i może być spowodować śmiertelne niebezpieczeństwo lub poważne obrażenia w wyniku porażenia prądem.

## OSTRZEŻENIE!

### Ryzyko obrażeń ciała lub uszkodzenia falownika

- Podczas pracy nie wolno dotykać żadnych elementów innych niż przetwornik DC i panel LCD.
- Nigdy nie należy podłączać ani odłączać złączy AC i DC, gdy falownik pracuje; a także.
- Przed przystąpieniem do konserwacji, czyszczenia lub prac przy podłączonych obwodach należy Wyłączyć zasilanie AC i DC oraz odłączyć te obwody od falownika. odczekać 5 minut w celu całkowitego rozładowania napięcia.
- Upewnij się, że wejściowe napięcie prądu stałego  $\leq$  maksymalne znamionowe napięcie wejściowe prądu stałego falownika. Przepięcie może spowodować trwałe uszkodzenie falownika, które NIE jest objęte gwarancją.

## PRZESTROGA!

- Nie wolno dopuszczać dzieci w pobliżu falownika.
- Należy zwrócić uwagę na ciężar falownika. W przypadku niewłaściwego obchodzenia się może dojść do obrażeń ciała; ponadto.











## UWAGA!

- Jeśli przepisy lokalne wymagają zastosowania zewnętrznego wyłącznika różnicowoprądowego, należy sprawdzić, jaki typ wyłącznika jest wymagany zgodnie z odpowiednimi przepisami elektrycznymi. Zaleca się stosowanie wyłącznika różnicowoprądowego RCD typu A o czułości 300 mA.
- Wszystkie etykiety produktu i tabliczka znamionowa na falowniku powinny być dobrze widoczne.

## Obecné upozornění

- Obsah může být pravidelně aktualizován nebo revidován. Společnost SolaX si vyhrazuje právo provádět vylepšení nebo změny v produktech a programech popsanych v této příručce bez předchozího upozornění.
- Instalaci, údržbu a nastavení týkající se sítě může provádět pouze kvalifikovaný personál, který:
  - je licencován a/nebo splňuje státní a místní regulační předpisy;
  - je dobře seznámen s touto příručkou a dalšími souvisejícími dokumenty.
- Před instalací zařízení si pozorně přečtete, plně pochopíte a přísně dodržujete podrobné pokyny v uživatelské příručce a další související předpisy. Společnost SolaX nenes odpovědnost za žádné následky způsobené porušením skladovacích, přepravních, instalačních a provozních předpisů uvedených v tomto dokumentu a uživatelské příručce.
- Při instalaci zařízení používejte izolované nástroje. Při instalaci, elektrickém připojení a údržbě je nutné nosit jednotlivé ochranné nástroje.
- Navštivte prosím webovou stránku [www.solaxpower.com](http://www.solaxpower.com) společnosti SolaX pro více informací.

## Popisy štítků

	Značka shody CE		Certifikace TUV
	Značka shody RCM		Pozor, horký povrch
	Další bod pro uzemnění		Pozor, nebezpečí
	Pozor, nebezpečí úrazu elektrickým proudem		Nelikvidujte měnič společně s domovním odpadem.
	Přečtete si příloženou dokumentaci.		
	Neprovozujte tento střídač, dokud není izolován od sítě a místních dodavatelů FV generátoru.		
	Nebezpečí vysokého napětí Nedotýkejte se částí pod napětím po dobu 5 minut po odpojení od zdrojů energie.		

**⚠ NEBEZPEČÍ!****Nebezpečí smrtelného úrazu elektrickým proudem v důsledku střídače**

- Měníč provozujte pouze tehdy, je-li technicky bezvadný. Jinak může dojít k úrazu elektrickým proudem nebo požáru.
- V žádném případě neotevírejte kryt bez povolení společnosti SolaX. Neoprávněné otevření způsobí neplatnost záruky a způsobí smrtelné nebezpečí nebo vážné zranění v důsledku úrazu elektrickým proudem.

**⚠ VAROVÁNÍ!****Nebezpečí zranění osob nebo poškození střídače**

- Během provozu se nedotýkejte jiných částí než vypínače stejnosměrného proudu a LCD panelu.
- Nikdy nepřipojujte ani neodpojujte konektory střídavého proudu ani konektory stejnosměrného proudu, když je střídač v chodu.
- Vypněte střídače a stejnosměrné napájení a odpojte je od střídače, počkejte 5 minut, než se napětí úplně vybije, než se pokusíte o jakoukoli údržbu, čištění nebo práci na připojených obvodech.
- Ujistěte se, že vstupní stejnosměrné napětí  $\leq$  DC vstupní stejnosměrné napětí střídače. Přepětí může způsobit trvalé poškození měniče, na které se NEVZTAHUJE záruka.

**⚠ POZOR!**

- Měníč udržujte mimo dosah dětí.
- Věnujte pozornost hmotnosti měniče. Při nesprávném zacházení může dojít ke zranění osob.











**OZNÁMENÍ!**

- Pokud místní předpisy vyžadují externí proudový chránič, zkontrolujte, jaký typ proudového chránič je vyžadován pro příslušné elektrické kódy. Doporučuje se použít proudový chránič typu A s hodnotou 300 mA.
- Všechny produktové štítky a typový štítek na střídači musí být dobře viditelné.

## Allmänt meddelande

- Innehållet kan uppdateras eller revideras regelbundet. SolaX förbehåller sig rätten att göra förbättringar eller ändringar i produkten/produkterna och programmet/programmen som beskrivs i denna handbok utan föregående meddelande.
- Installation, underhåll och elnätsrelaterad inställning kan endast utföras av kvalificerad personal som:
  - Är licensierade och/eller uppfyller statliga och lokala jurisdiktionsbestämmelser;
  - Har god kännedom om denna handbok och andra relaterade dokument.
- Innan du installerar enheten, läs noggrant, förstå och följ noggrant de detaljerade anvisningarna i användarhandboken och andra relaterade regler. SolaX ansvarar inte för några konsekvenser som orsakas av brott mot lagrings-, transport-, installations- och driftsföreskrifterna som anges i detta dokument och användarhandboken.
- Använd isolerade verktyg när du installerar enheten. Individuell skyddsutrustning måste bäras under installation, elektrisk anslutning och underhåll.
- Besök webbplatsen [www.solaxpower.com](http://www.solaxpower.com) av SolaX för mer information.

## Beskrivningar av etiketter

	CE-märke för överensstämmelse		TUV-certifiering
	RCM-märke för överensstämmelse		Försiktighet, het yta
	Ytterligare jordningspunkt		Försiktighet, risk för fara
	Försiktighet, risk för elektrisk stöt		Kassera inte växelriktaren tillsammans med hushållsavfallet.
	Läs bifogad dokumentation		
	Använd inte denna växelriktare förrän den är isolerad från elnätet och försörjningen från solcellsanläggningen.		
	Risk för högspänning. Rör inte vid spänningsförändringsdelar under 5 minuter efter frånkoppling från strömkällorna.		

 **FARA!****Dödlig fara från elektriska stötar på grund av växelriktaren**

- Använd endast växelriktaren när den är tekniskt felfri. Annars kan elektriska stötar eller brand uppstå.
- Öppna inte höljet under några omständigheter utan tillstånd från SolaX. Obehörig öppning upphäver garantin och orsakar dödlig fara eller allvarlig skada på grund av elektriska stötar.

 **VARNING!****Risk för personskada eller skador på växelriktaren**

- Under drift, rör inte några andra delar än CD-omkopplare och LCD-panelen.
- Anslut eller koppla aldrig ur AC- och DC-kontakterna när växelriktaren är igång.
- Stäng av AC- och DC-försörjningen och koppla bort dem från växelriktaren, vänta i 5 minuter för att helt ladda ur spänningen innan du utför underhåll, rengöring eller arbete på anslutna kretsar.
- Se till att den ingående DC-spänning  $\leq$  maximal DC-spänning hos växelriktaren. Överspänning kan orsaka permanent skada på växelriktaren, som INTE täcks av garantin.

 **FÖRSIKTIGHET!**

- Håll barn borta från växelriktaren.
- Var uppmärksam på växelriktarens vikt. Det kan leda till personskador de inte hanteras korrekt.

**OBS!**











- Om en extern jordfelsbrytare krävs enligt lokala bestämmelser, kontrollera vilken typ av jordfelsbrytare som krävs för relevanta elektriska bestämmelser. Det rekommenderas att använda en typ-A RCD med värdet 300 mA.
- Alla produktetiketter och typskylten på växelriktaren ska vara tydligt synliga.



## Notă generală

1. Conținutul poate fi actualizat sau revizuit periodic. SolaX își rezervă dreptul de a aduce îmbunătățiri sau modificări produsului (produselor) și programului (programelor) descrise în acest manual fără notificare prealabilă.
2. Instalarea, întreținerea și setarea rețelei pot fi efectuate numai de personal calificat care:
  - Deține licență și/sau îndeplinește reglementările jurisdicționale de stat și locale;
  - Cunoaște bine acest manual și alte documente conexe.
3. Înainte de a instala dispozitivul, citiți cu atenție, înțelegeți pe deplin și urmați cu strictețe instrucțiunile detaliate din manualul de utilizare și alte reglementări aferente. Compania SolaX nu va fi responsabilă pentru nicio consecință cauzată de încălcarea regulamentelor de depozitare, transport, instalare și operare specificate în acest document și în manualul de utilizare.
4. Pentru instalarea dispozitivului, utilizați unelte izolate. În timpul instalării, conectării electrice și întreținerii trebuie purtate echipamente individuale de protecție.
5. Vizitați site-ul web [www.solaxpower.com](http://www.solaxpower.com) al SolaX pentru mai multe informații.

## Descrierile etichetelor

	Marcaj de conformitate CE		Certificare TUV
	Marcaj de conformitate RCM		Atenție, suprafață fierbinte
	Punct suplimentar de împământare		Atenție, risc de pericol
	Atenție, risc de electrocutare		Nu aruncați inverterul împreună cu deșeurile menajere.
	Citiți documentațiile anexate		
	Nu utilizați acest inverter până când nu este deconectat de la rețea și de la furnizorii de generare PV de la fața locului.		
	Pericol de înaltă tensiune. Nu atingeți părțile sub tensiune timp de 5 minute după deconectarea de la sursele de alimentare.		

## PERICOL!

### Pericol de deces cauzat prin electrocutare din cauza invertorului

- Utilizați invertorul numai dacă nu are defecțiuni tehnice. În caz contrar, poate apărea electrocutare sau incendiu.
- Nu deschideți în niciun caz carcasa fără autorizația SolaX. Deschiderea neautorizată va anula garanția și va cauza pericol letal sau vătămare gravă prin electrocutare.

## AVERTIZARE!

### Risc de rănire a personalului sau deteriorare a invertorului

- În timpul funcționării, nu atingeți alte părți, cu excepția comutatorului de c.c. și a panoului LCD.
- Nu conectați sau deconectați niciodată conectorii de c.a. și c.c. când invertorul funcționează.
- Opriți alimentarea c.a. și c.c. și deconectați-le de la invertor, așteptați 5 minute pentru a descărca complet tensiunea înainte de a încerca orice întreținere, curățare sau lucrare la orice circuit conectat.
- Asigurați-vă că tensiunea de intrare de c.c.  $\leq$  Tensiunea maximă de intrare c.c. a invertorului. Supratensiunea poate cauza deteriorarea permanentă a invertorului, care NU este acoperită de garanție.

## ATENȚIE!

- Nu lăsați copiii în apropierea invertorului.
- Fiți atenți la greutatea invertorului. Dacă nu este manipulat corespunzător, pot fi cauzate vătămări personale.







## NOTĂ!

- Dacă reglementările locale impun un RCD extern, verificați ce tip de RCD este necesar pentru codurile electrice relevante. Se recomandă utilizarea unui RCD tip A cu valoarea de 300 mA.
- Toate etichetele produselor și plăcuța de identificare de pe invertor trebuie să fie menținute vizibile clar.

## Общи положения

- Съдържанието може да се обновява или ревизира периодично. SolaX си запазва правото да прави подобрения или промени в продукта (продуктите) и програмата (програмите), описани в това ръководство, без предизвестие.
- Монтажът, обслужването и свързването с електрическата мрежа следва да се извършват само от квалифицирани техници, които:
  - Притежават съответния лиценз и/или отговарят на държавните или общинските изисквания;
  - Познават добре това ръководство и свързаната документация.
- Преди монтажа на устройството трябва да прочетете внимателно, да разберете напълно и да спазвате стриктно подробните инструкции на ръководството за потребителя и свързаните разпоредби. SolaX не носи отговорност за никакви последици, причинени от неспазване на инструкциите за съхранение, транспортиране, монтаж и експлоатация, посочени в този документ и в ръководството за потребителя.
- Използвайте изолирани инструменти за монтажа на устройството. Носете лични предпазни средства по време на монтажа, електрическото свързване и обслужването.
- Посетете уеб сайта на SolaX [www.solaxpower.com](http://www.solaxpower.com) за повече информация.

## Описание на стикерите

	CE маркировка за съответствие		TUV сертификация
	RCM маркировка за съответствие		Внимание - гореща повърхност
	Допълнителна точка за заземяване		Внимание - риск от опасност
	Внимание - риск от токов удар		Не изхвърляйте инвертора заедно с битовите отпадъци.
	Прочетете приложената документация		
	Не работете с инвертора, докато не бъде разединен от мрежата и от локалните PV системи.		
	Опасност от високо напрежение. Не докосвайте тоководещи части 5 минути след изключване на захранването.		

## ОПАСНОСТ!

### Смъртоносна опасност от токов удар

- Използвайте инвертора само когато е технически изправен. В противен случай има риск от токов удар или пожар.
- При никакви обстоятелства не отваряйте корпуса без разрешение от SolaX. Неоторизираното отваряне на корпуса ще анулира гаранцията и ще доведе до смъртоносна опасност или сериозна травма поради токов удар.

## ПРЕДУПРЕЖДЕНИЕ!

### Риск от физическа травма или повреда на инвертора

- По време на работа не пипайте никакви други части освен DC превключвателя и LCD панела.
- Никога не включвайте и не изключвайте AC и DC конекторите, докато инверторът работи.
- Изключете променливотоковото и правотоковото захранване, разкачете ги от инвертора и изчакайте 5 минути напрежението да изчезне напълно, преди да пристъпите към обслужване, почистване или друга работа по свързаните вериги.
- Уверете се, че входното правотоково напрежение е  $\leq$  на максималното правотоково входно напрежение на инвертора. Свърхнапрежението може да повреди трайно инвертора, а това НЕ се покрива от гаранцията.

## ВНИМАНИЕ!

- Не допускайте деца в близост до инвертора.
- Имате предвид теглото на инвертора. Неправилната работа може да доведе до злополуки.

## БЕЛЕЖКА!













- Ако местните разпоредби изискват да се използва външна ДТЗ, проверете какъв тип ДТЗ се изисква за съответните електрически кодове. Препоръчва се да се използва ДТЗ тип А със стойност 300 mA.
- Всички стикери и заводската табелка на инвертора трябва да се поддържат чисти.

# Sikkerhed

## Generel meddelelse

1. Indholdet kan blive opdateret eller revideret regelmæssigt. SolaX forbeholder sig retten til at foretage forbedringer eller ændringer i produktet/produkterne og programmerne beskrevet i denne manual uden forudgående varsel.
2. Installation, vedligeholdelse og netrelateret indstilling kan kun udføres af kvalificeret personale, som:
  - Er licenseret og/eller opfylder statslige og lokale jurisdiktionsregler
  - Har godt kendskab til denne manual og andre relaterede dokumenter.
3. Før du installerer enheden, skal du omhyggeligt læse, forstå og nøje følge den detaljerede vejledning i brugervejledningen og andre relaterede regler. SolaX hæfter ikke for eventuelle konsekvenser forårsaget af overtrædelse af opbevarings-, transport-, installations- og betjeningsreglerne specificeret i dette dokument og brugervejledningen.
4. Brug isoleret værktøj, når du installerer enheden. Individuelt beskyttelsesværktøj skal benyttes under installation, elektrisk tilslutning og vedligeholdelse.
5. Besøg venligst hjemmesiden [www.solaxpower.com](http://www.solaxpower.com) for SolaX for mere information.

## Mærkatbeskrivelser

	CE-overensstemmelsesmærke		TÜV-certificering
	RCM-overensstemmelsesmærke		Forsigtig, varm overflade
	Ekstra jordingspunkt		Forsigtig, risiko for fare
	Forsigtig, risiko for elektrisk stød		Bortskaf ikke vekselretteren sammen med husholdningsaffald.
	Læs den vedlagte dokumentation		
	Betjen ikke denne vekselretter, før den er isoleret fra lysnettet og PV-generende moduler på stedet.		
 	Højspændingsfare Rør ikke ved spændingsførende dele i 5 minutter efter frakobling fra strømkilderne.		

**FARE!****Livsfare på grund af elektrisk stød fra vekselretteren**

- Vekselretteren må kun betjenes, når den er teknisk fejlfri. I modsat fald kan der opstå elektrisk stød eller brand.
- Kabinettet må under ingen omstændigheder åbnes uden forudgående godkendelse fra SolaX. Uautoriseret åbning vil ugyldiggøre garantien og forårsage livsfare eller alvorlig skade på grund af elektrisk stød.

**ADVARSEL!****Risiko for personskade eller skade på vekselretteren**

- Under drift må du ikke røre ved andre dele end jævnstrømsafbryderen (DC) og LCD-panelet.
- Tilslut eller frakobl aldrig vekselstrøms- (AC) og jævnstrømsstikkene (DC), når vekselretteren kører.
- Sluk for AC- og DC-strømmen, og afbryd dem fra vekselretteren, vent i 5 minutter for at aflade spændingen helt, før du forsøger at udføre vedligeholdelse, rengøring eller arbejde på tilsluttede kredsløb.
- Sørg for, at DC-indgangsspændingen  $\leq$  Maksimal DC-indgangsspænding for vekselretteren, Overspænding kan forårsage permanent skade på vekselretteren, hvilket IKKE er dækket af garantien.

**FORSIGTIG!**

- Hold børn væk fra vekselretteren.
- Vær opmærksom på vekselretterens vægt. Der kan opstå personskade, hvis den ikke håndteres korrekt.

**BEMÆRK!**











- Hvis en ekstern fejlstrømsafbryder er påkrævet i henhold til lokale regler, skal du kontrollere, hvilken type fejlstrømsafbryder, der kræves til relevante elforskrifter. Det anbefales at bruge en Type-A-fejlstrømsenhed med en værdi på 300 mA.
- Alle produktetiketter og navneskilt på vekselretteren skal altid være klart synlige.

## Ασφάλεια

### Γενικές ειδοποιήσεις

1. Τα περιεχόμενα μπορεί να ενημερώνονται ή να αναθεωρούνται περιοδικά. Η SolaX διατηρεί το δικαίωμα να προχωρήσει σε βελτιώσεις ή αλλαγές στο προϊόν(τα) και το πρόγραμμα(τα) που περιγράφονται σε αυτό το εγχειρίδιο χωρίς προηγούμενη ειδοποίηση.
2. Η εγκατάσταση, συντήρηση και η τοποθέτηση που σχετίζονται με το πλέγμα μπορούν να πραγματοποιηθούν μόνο από εξειδικευμένο προσωπικό που:
  - Διαθέτει άδεια και/ή πληροί τους κανονισμούς της πολιτείας και των τοπικών αρμόδιων.
  - Έχει καλή γνώση αυτού του εγχειριδίου και άλλων σχετικών εγγράφων.
3. Πριν από την εγκατάσταση της συσκευής, διαβάστε προσεκτικά, κατανοήστε πλήρως και τηρήστε πιστά τις σχετικές οδηγίες του εγχειριδίου χρήσης και άλλων σχετικών κανονισμών. Η SolaX δεν φέρει ευθύνη για οποιεσδήποτε συνέπειες προκαλούνται από παραβίαση των κανονισμών φύλαξης, μεταφοράς, εγκατάστασης και λειτουργίας που ορίζονται σε αυτό το έγγραφο και το εγχειρίδιο χρήσης.
4. Χρησιμοποιήστε μονωμένα εργαλεία κατά την εγκατάσταση της συσκευής. Τα ατομικά εργαλεία προστασίας πρέπει να φοριούνται κατά την εγκατάσταση, ηλεκτρική σύνδεση και συντήρηση.
5. Επισκεφθείτε τον ιστότοπο [www.solaxpower.com](http://www.solaxpower.com) της SolaX για περισσότερες πληροφορίες.

### Περιγραφές ετικετών

	Σήμανση συμμόρφωσης CE		Πιστοποίηση TUV
	Σήμανση συμμόρφωσης RCM		Προσοχή, καυτή επιφάνεια
	Πρόσθετο σημείο γείωσης		Προσοχή, κίνδυνος
	Προσοχή, πιθανότητα ηλεκτροπληξίας		Μην απορρίπτετε το inverter μαζί με τα οικιακά απορρίμματα.
	Διαβάστε τα εσωκλειστα έγγραφα		
	Μην λειτουργείτε αυτό το inverter έως ότου απομονωθεί από το ρεύμα και από τους παρόχους παραγωγής PV στον χώρο.		
	Κίνδυνος υψηλής τάσης. Μην αγγίζετε τα ηλεκτροφόρα μέρη για 5 λεπτά μετά την αποσύνδεση από τις πηγές ρεύματος.		

## ΚΙΝΔΥΝΟΣ!

### Θανάσιμος κίνδυνος από ηλεκτροπληξία λόγω του inverter

- Χρησιμοποιείτε το inverter μόνο όταν δεν έχει τεχνικά σφάλματα. Διαφορετικά, υπάρχει πιθανότητα ηλεκτροπληξίας ή πυρκαγιάς.
- Μην ανοίγετε το κάλυμμα σε καμία περίπτωση χωρίς έγκριση από τη SolaX. Μη εξουσιοδοτημένο άνοιγμα θα ακυρώσει την εγγύηση και να προκαλέσει θανάσιμο κίνδυνο ή σοβαρό τραυματισμό λόγω ηλεκτροπληξίας.

## ΠΡΟΕΙΔΟΠΟΙΗΣΗ!

### Κίνδυνος τραυματισμού προσωπικού ή βλάβη στο inverter

- Κατά τη λειτουργία, μην αγγίζετε κανένα μέρος εκτός από τον διακόπτη DC, το πάνελ LCD.
- Ποτέ μη συνδέετε ή αποσυνδέετε τις συνδέσεις AC και DC όταν το inverter λειτουργεί.
- Απενεργοποιήστε το ρεύμα AC και DC και αποσυνδέστε τα από το inverter, περιμένετε 5 λεπτά ώστε η τάση να αποφορτιστεί πλήρως πριν επιχειρήσετε οποιαδήποτε συντήρηση, καθαρισμό ή εργασία σε οποιοδήποτε συνδεδεμένο κύκλωμα.
- Βεβαιωθείτε ότι η τάση DC εισόδου  $\leq$  Μέγιστη τάση εισόδου DC του inverter. Η υπέρταση μπορεί να προκαλέσει μόνιμη βλάβη στο inverter, η οποία ΔΕΝ καλύπτεται από την εγγύηση.

## ΠΡΟΣΟΧΗ!

- Κρατήστε τα παιδιά μακριά από το Inverter.
- Προσέξτε το βάρος του inverter. Υπάρχει πιθανότητα προσωπικών τραυματισμών σε περίπτωση εσφαλμένου χειρισμού.

## ΕΙΔΟΠΟΙΗΣΗ!











- Εάν απαιτείται εξωτερικό RCD από τους τοπικούς κανονισμούς, ελέγξτε ποιος τύπος RCD απαιτείται για σχετικούς ηλεκτρικούς κωδικούς. Συνιστάται να χρησιμοποιείται Τύπος-A-RCD με την τιμή 300mA.
- Όλες οι ετικέτες προϊόντων και ταμπέλες επάνω στο Inverter θα παραμείνουν ξεκάθαρα ορατές.



## Üldised märkused

1. Sisu võidakse perioodiliselt ajakohastada või läbi vaadata. SolaX jätab endale õiguse teha selles juhendis kirjeldatud tootes (toodetes) ja programmi(de)s parandusi või muudatusi ilma eelneva etteatamiseta.
2. Paigaldamist, hooldust ja võrguga seotud seadistamist võivad teha ainult kvalifitseeritud töötajad, kes:
  - on litsentseeritud ja/või vastavad riiklikele ja kohalikele õiguseeskirjadele;
  - tunnevad hästi käesolevat kasutusjuhendit ja muid sellega seotud dokumente.
3. Enne seadme paigaldamist lugege hoolikalt läbi, saage täielikult aru ja järgige rangelt kasutusjuhendi üksikasjalikke suuniseid ja muid seonduvaid eeskirju. SolaX ei vastuta tagajärgede eest, mis tulenevad käesolevas dokumendis ning kasutusjuhendis sätestatud ladustamis-, transpordi-, paigaldus- ja käitamishooldusnormide eiramisest.
4. Kasutage seadme paigaldamisel isoleeritud tööriistu. Paigaldamise, elektrilise ühendamise ja hoolduse ajal tuleb kanda isikukaitsevahendeid.
5. Lisateavet leiate SolaXi veebilehelt [www.solaxpower.com](http://www.solaxpower.com).

## Tähiste kirjeldused

	CE-vastavusmärk		TÜV sertifikaat
	RCM-vastavusmärk		Ettevaatust, kuum pind
	Täiendav maanduspunkt		Ettevaatust, oht
	Ettevaatust, elektrilöögi oht		Ärge visake inverterit ära koos olmejäätmetega.
	Lugege lisatud dokumente		
	Ärge kasutage inverterit enne, kui see on isoleeritud vooluvõrgust ja kohapealsetest päikeseenergia tootjatest.		
	Kõrgepinge oht. Ärge puudutage pinget all olevaid osi 5 minuti jooksul pärast vooluvõrgust lahtiühendamist.		

**OHT!****Inverterist tulenev surmav elektrilöögi oht**

- Kasutage inverterit ainult siis, kui see on tehniliselt töökorras. Muidu võib tekkida elektrilööök või tulekahju.
- Ärge mingil juhul avage korpust ilma SolaXi loata. Ilma loata avamine muudab garantii kehtetuks ja põhjustab elektrilöögi tõttu surmaohtu või raskeid vigastusi.

**HOIATUS!****Töötajate vigastuste või inverteri kahjustamise oht**

- Arge puudutage tootamise ajal muid osi peale alalisvoolu lüliti ja LCD-paneeli.
- Ärge kunagi ühendage ega lahutage vahelduv- ega alalisvooluühendusi inverteri töötamise ajal.
- Lülitage vahelduv- ja alalisvoolu toide välja ning ühendage need inverterist lahti, oodake 5 minutit, et pinge täielikult tühjeneks, enne kui püüate teha hooldustöid, puhastamist või tööd ühendatud vooluahelate kallal.
- Veenduge, et inverteri sisend-alalispinge  $\leq$  maksimaalne sisend-alalispinge. Ülepinge võib põhjustada inverterile püsivaid kahjustusi, mida garantii EI kata.

**HOIATUS!**

- Hoidke lapsed inverterist eemal.
- Pöörake tähelepanu inverteri kaalule. Nõuete eiramine võib põhjustada kehavigastusi.

**TÄHELEPANU!**











- Kui kohalikud eeskirjad nõuavad välist kaitselüliti, kontrollige, millist tüüpi kaitselüliti asjaomased elektrieskirjad nõuavad. Soovitav on kasutada A-tüüpi kaitselüliti väärtusega 300 mA.
- Kõik inverteril olevad tootesildid ja nimesildid peavad olema selgelt nähtavad.

## Turvallisuus

### Yleinen ilmoitus

1. Sisältöä saatetaan päivittää tai muuttaa ajoittain. SolaX varaa oikeuden tehdä parannuksia ja muutoksia tässä oppaassa kuvattuihin tuotteisiin ja ohjelmiin ilman ennakoilmoitusta.
2. Asennus, huolto ja sähköverkkoon liittyvät asetukset on annettava sellaisen pätevän henkilöstön hoidettavaksi, joka täyttää seuraavat vaatimukset:
  - on lisensoitu ja/tai täyttää osavaltion ja paikallisen lainsäädännön vaatimukset
  - tuntee tämän oppaan ja muut aiheeseen liittyvät asiakirjat hyvin
3. Ennen kuin asennat laitteen, lue käyttöohjeen yksityiskohtaiset ohjeet ja muut aiheeseen liittyvät säännökset huolella, ymmärrä ne täysin ja noudata niitä tarkkaan. SolaX ei ole vastuussa mistään seuraamuksista, jotka johtuvat tämän asiakirjan ja käyttöoppaan säilytys-, kuljetus-, asennus- ja käyttöohjeiden rikkomisesta.
4. Käytä laitetta asentaessasi eristettyjä työkaluja. Asennuksen, sähkökytkentöjen ja huollon aikana on käytettävä henkilökohtaisia suojaavia työkaluja.
5. Lisätietoja on SolaXin sivustolla [www.solaxpower.com](http://www.solaxpower.com).

### Kylttien kuvaukset

	CE-vaatimustenmukaisuusmerkki		TUV-sertifikaatti
	RCM-vaatimustenmukaisuusmerkki		Varoitus, kuuma pinta
	Ylimääräiset maadoituskohdat		Huomio, vaaran mahdollisuus
	Huomio, sähköiskun vaara		Älä hävitä invertteritä kotitalousjätteen mukana.
	Lue mukana tulevat asiakirjat		
	Älä käytä tätä invertteritä, ennen kuin se on eristetty verkkovirrasta ja paikan päällä sijaitsevista aurinkosähkötoimittajista.		
	Suurjännitteen vaara. Älä kosketa sähköistettyjä osia 5 minuuttiin laitteen irrottamisesta virtalähteestä.		

 VAARA!

**Hengenvaara invertteristä aiheutuvan sähköiskun vaaran takia**

- Käytä invertteriä vain, kun se on teknisesti moitteeton. Muutoin seurauksena voi olla sähköisku tai tulipalo.
- Älä avaa koteloita missään tapauksessa ilman SolaX:n lupaa. Luvaton avaaminen mitätöi takuun ja voi aiheuttaa hengenvaaran tai vakavan vamman sähköiskun takia.

 VAROITUS!

**Loukkaantumisen tai invertterin vahingoittumisen vaara**

- Älä kosketa käytön aikana mitään muita osia kuin DC-kytkintä ja LCD-paneelia.
- Älä koskaan kytke tai irrota AC- ja DC-liittimiä invertterin ollessa käynnissä.
- Kytke AC- ja DC-virta pois päältä ja irrota ne invertteristä ja odota 5 minuuttia, jotta jännite purkautuu täysin, ennen kuin yrität huoltaa, puhdistaa tai käsitellä mitään kytkettyjä piirejä.
- Varmista, että tulotasajännite  $\leq$  invertterin suurin tulotasajännite. Ylijännite voi aiheuttaa invertterille pysyviä vaurioita, joita takuu EI kata.

 HUOMIO!

- Pidä lapset kaukana invertteristä.
- Huomioi invertterin paino. Virheellisestä käsittelystä voi seurata loukkaantumisia.











**HUOMAUTUS!**

- Jos paikalliset määräykset edellyttävät ulkoista vikavirtasuojaa, tarkista, minkä tyyppinen vikavirtasuojaa asianmukaisissa sähkösäätöyksissä vaaditaan. Suosittelemme käyttämään A-tyypin 300 mA:n vikavirtasuojaa.
- Kaikki invertterin tuotemerkinnät ja nimikilpi on pidettävä selkeästi näkyvillä.

## Opća obavijest

- Sadržaj se može povremeno ažurirati ili mijenjati. Tvrtka SolaX zadržava pravo izvršiti poboljšanja ili izmjene na proizvodima i programima opisanim u ovom priručniku bez prethodne obavijesti.
- Ugradnju, održavanje i postavljanje u vezi s mrežom smije vršiti samo kvalificirano osoblje koje:
  - ima licencu i/ili udovoljava propisima u državnoj i lokalnoj nadležnosti;
  - dobro poznaje ovaj priručnik i druge povezane dokumente.
- Prije ugradnje uređaja pažljivo pročitajte, u potpunosti usvojite i strogo slijedite podrobne upute korisničkog priručnika i druge povezane propise. Tvrtka SolaX nije odgovorna ni za koje posljedice prouzročene kršenjem propisa o skladištenju, prijevozu, ugradnji i rukovanju koji su navedeni u ovom dokumentu i korisničkom priručniku.
- Pri ugradnji uređaja upotrebljavajte izolirane alate. Obvezno je nošenje osobne zaštitne opreme pri ugradnji, priključivanju električne energije i održavanju.
- Za više informacija posjetite web-mjesto tvrtke SolaX: [www.solaxpower.com](http://www.solaxpower.com).

## Opisi oznaka

	Oznaka sukladnosti CE		Certifikacija TUV
	Oznaka sukladnosti RCM		Oprez, vruća površina
	Dodatno mjesto uzemljenja		Oprez, rizik od opasnosti
	Oprez, rizik od strujnog udara		Ne odlažite izmjenjivač zajedno s kućanskim otpadom.
	Pročitajte priloženu dokumentaciju		
	Ne rukujte ovim izmjenjivačem sve dok ne bude izoliran s mrežnog napajanja i dovoda fotonaponske energije na lokaciji.		
	Opasnost od visokog napona. Ne dodirujte dijelove pod naponom 5 minuta nakon isključivanja s izvora energije.		

## OPASNOST!

### Smrtonosna opasnost od strujnog udara pri uporabi izmjenjivača

- Rukujte izmjenjivačem samo kada je potpuno tehnički ispravan. U suprotnom može doći do strujnog udara ili požara.
- Ni u kojem slučaju ne otvarajte kućište bez odobrenja tvrtke SolaX. Neovlašteno otvaranje poništava jamstvo te može prouzročiti smrtonosnu opasnost ili tešku ozljedu uslijed strujnog udara.

## UPOZORENJE!

### Rizik od ozljeđivanja osoblja ili oštećenja izmjenjivača

- Tijekom rada nemojte dodirivati nijedan dio izmjenjivača osim prekidača istosmjerne struje i LCD ploče.
- Nikada nemojte uključivati ili isključivati priključke izmjenične i istosmjerne struje dok izmjenjivač radi.
- Prije početka svakog održavanja, čišćenja ili rada na bilo kojem priključenom strujnom krugu, isključite izmjenično i istosmjerno napajanje i isključite ih s izmjenjivača te pričekajte 5 minuta kako bi se napon potpuno ispraznio.
- Vodite računa da je ulazni napon istosmjerne struje  $\leq$  maksimalnim ulaznim naponom istosmjerne struje na izmjenjivaču. Prenapon može prouzročiti trajno oštećenje izmjenjivača, a ono NIJE obuhvaćeno jamstvom.

## OPREZ!

- Držite djecu podalje od izmjenjivača.
- Obratite pozornost na težinu izmjenjivača. Ako se njime ne rukuje ispravno, može doći do tjelesnih ozljeda.











## OBVIJEST!

- Ako lokalni propisi zahtijevaju vanjski RCD, provjerite koji tip RCD-a je potreban za odgovarajuće električne značajke. Preporučuje se koristiti se RCD-om tipa A s vrijednošću od 300 mA.
- Sve oznake proizvoda i natpisna pločica izmjenjivača moraju biti jasno vidljive.

## Általános tájékoztató

1. A tájékoztató tartalma időről időre frissülhet vagy átdolgozásra kerülhet. A SolaX fenntartja a jogot az ebben a kézikönyvben ismertetett termék(ek) és a program(ok) előzetes értesítés nélkül történő javítására.
2. A telepítést, karbantartást és a hálózattal kapcsolatos beállításokat kizárólag olyan képesített személyzet végezheti, amely:
  - az állami és helyi engedéllyel rendelkezik és/vagy jogszabályok előírásainak megfelelnek;
  - ezt a kézikönyvet és az egyéb kapcsolódó dokumentumokat jól ismerik.
3. A készülék telepítése előtt gondosan olvassa el, értelmezze teljes mértékben és szigorúan kövesse a felhasználói kézikönyv és egyéb kapcsolódó szabályozások részletes utasításait. A SolaX nem köteles helytállni az ebben a dokumentumban és a felhasználói kézikönyvben meghatározott tárolási, szállítási, telepítési és üzemeltetési szabályok megszegésével okozott semmilyen következményért.
4. A készülék telepítése során szigetelt szerszámokat használjon. A telepítés, az elektromos bekötés és a karbantartás elvégzése során kötelező egyéni védőeszközt viselni.
5. Bővebb tájékoztatásért keresse fel a SolaX honlapját a [www.solaxpower.com](http://www.solaxpower.com) címen.

## Címkék ismertetése

	CE megfelelési jelzés		TÜV tanúsítvány
	RCM megfelelési jelzés		Vigyázat, forró felület
	További földelési pont		Vigyázat, veszély kockázata
	Vigyázat, áramütés veszélye		Az invertert ne háztartási hulladékkal ártalmatlanítsa.
	Olvassa el a mellékelt dokumentációkat		
	Az invertert csak akkor üzemeltesse, ha már elszigetelte a fő áramellátástól és a telephelyi PV generátoroktól.		
	Nagyfeszültség veszélye. Az áramellátásról való leválasztást követően 5 percig ne érjen az élesüzemi részekhez.		

## VESZÉLY!

### Az inverter miatt a halálos áramütés veszélye áll fenn

- Az invertert kizárólag akkor üzemeltesse, ha műszakilag hibátlan. Egyébként áramütésre vagy tüzre kerülhet sor.
- A nyílást a SolaX engedélye nélkül semmilyen esetben ne nyissa ki. Az engedély nélküli nyitás a jótállás érvénytelenségét eredményezi, és áramütés miatt halálos veszélyt vagy súlyos sérülést okozhat.

## VIGYÁZAT!

### Személyi sérülés vagy az inverter károsodásának kockázata

- Üzemelés során kizárólag az inverter DC kapcsolójához és LDC paneléhez érhet hozzá.
- Az inverter üzemelése közben soha ne csatlakoztassa vagy válassza le a váltóáramú és egyenáramú csatlakozókat.
- Kapcsolja ki a váltó- és egyenáramú tápellátást és válassza le az inverterről, várjon 5 percet a feszültség teljes kisüléséig, és csak ezt követően próbálja meg a karbantartási, tisztítási vagy bármely csatlakozó áramkörön végzendő munkát megkezdni.
- Győződjön meg róla, hogy a bemenő egyenáramú feszültség legalább egyenlő az inverter maximális egyenáramú bemenő feszültségével. A túlfeszültség az inverter tartós károsodását okozhatja, amelyre a jótállás NEM vonatkozik.

## VIGYÁZAT!

- A gyermekeket tartsa távol az invertertől.
- Figyelje az inverter súlyát. A nem megfelelő kezelés személyi sérülést okozhat.

## FIGYELEM!











- Ha a helyi szabályozások külső érintésvédelmi relé alkalmazását írják elő, ellenőrizze, milyen típusú érintésvédelmi berendezésre van szükség a vonatkozó elektromos szabályozások szerint. Javasolt 300 mA értékű A típusú érintésvédelmi relét alkalmazni.
- Az inverter összes termékcímkéjét és adattábláját mindig jól láthatóan kell karbantartani.



## Bendroji pastaba

1. Turinys gali būti periodiškai atnaujinamas arba peržiūrimas. „SolaX“ pasilieka teisę tobulinti ar keisti šiame vadove aprašytą (-us) produktą (-us) ir programą (-as) be išankstinio įspėjimo.
2. Montavimo, techninės priežiūros ir su tinklu susijusius paruošimo darbus gali atlikti tik kvalifikuoti darbuotojai, kurie:
  - turi licenciją ir (arba) atitinka valstybės ir vietos jurisdikcijos taisykles;
  - gerai išmano šį vadovą ir kitus susijusius dokumentus.
3. Prieš montuodami įrenginį atidžiai perskaitykite, visiškai supraskite ir griežtai laikykitės išsamių naudotojo vadovo ir kitų susijusių taisyklių nurodymų. „SolaX“ neatsako už jokias pasekmes, atsiradusias dėl šiame dokumente ir naudotojo vadove nurodytų laikymo, transportavimo, montavimo ir naudojimo taisyklių nesilaikymo.
4. Montuodami prietaisą naudokite izoliuotus įrankius. Montuojant, prijungiant prie elektros tinklo ir atliekant techninę priežiūrą būtina dėvėti individualias apsaugos priemones.
5. Daugiau informacijos rasite „SolaX“ svetainėje [www.solaxpower.com](http://www.solaxpower.com).

## Užrašų aprašymai

	CE atitikties ženklas		TUV sertifikavimas
	RCM atitikties ženklas		Atsargiai, karštas paviršius
	Papildomas įžeminimo kontaktas		Atsargiai, pavojinga
	Atsargiai, elektros smūgio pavojus		Neišmeskite inverterio su buitiniemis atliekomis.
	Perskaitykite pridamus dokumentus		
	Nenaudokite šio inverterio, kol jis nebus atjungtas nuo elektros tinklo ir vietoje veikiančių fotovoltinės energijos gamybos tiekėjų.		
	Aukštos įtampos pavojus. 5 minutes po atjungimo nuo maitinimo šaltinių nelieskite įtampą turinčių dalių.		

## PAVOJUS!

### Mirtinas elektros smūgio pavojus dėl inverterio

- Inverterį naudokite tik tada, kai jis yra techniškai tvarkingas. Priešingu atveju gali išstikti elektros smūgis arba kilti gaisras.
- Jokiu būdu neatidarykite korpuso be „SolaX“ leidimo. Atidarymas be leidimo panaikins garantijos galiojimą ir sukels mirtiną pavojų arba rimtus sužalojimus dėl elektros smūgio.

## ĮSPĖJIMAS!

### Personalo sužeidimo arba inverterio pažeidimo rizika

- Naudodami nelieskite jokių kitų dalių, išskyrus nuolatinės srovės (DC) jungiklį ir skystųjų kristalų skydelį.
- Niekada nejunkite ir neatjunkite kintamosios ir nuolatinės srovės jungčių, kai veikia inverteris.
- Išjunkite kintamosios (AC) ir nuolatinės srovės (DC) maitinimus ir atjunkite juos nuo inverterio; tuomet palaukite 5 minutes, kad įtampa visiškai nukristų, prieš atlikdami bet kokius techninės priežiūros darbus, valydami ar dirbdami su bet kokiomis prijungtomis grandinėmis.
- Įsitikinkite, kad nuolatinės srovės (DC) jėgimo įtampa  $\leq$  už maksimalią inverterio nuolatinės srovės (DC) jėgimo įtampą. Viršįtampis gali sukelti nuolatinę žalą inverteriui; tokiu atveju garantija NĖRA taikoma.

## DĖMESIO!

- Neleiskite vaikams būti prie inverterio.
- Atkreipkite dėmesį į inverterio svorį. Netinkamai elgiantis gali būti sužaloti žmonės.











## PASTABA!

- Jei pagal vietines taisykles reikalaujama naudoti išorinę srovės nuotėkio relę (RCD), patikrinkite, kokio tipo srovės nuotėkio relė reikalaujama pagal atitinkamas elektros taisykles. Rekomenduojama naudoti A tipo srovės nuotėkio relę, kurios vardinė srovė yra 300 mA.
- Visi ant inverterio esantys produkto užrašai ir vardinė lentelė turi būti gerai matomi.

## Vispārīgs paziņojums

1. Saturs periodiski var tikt atjaunots vai pārskatīts. SolaX patur tiesības bez iepriekšēja brīdinājuma veikt šajā rokasgrāmatā aprakstītā(-o) izstrādājuma(-u) un programmas(-u) uzlabojumus un izmaiņas.
2. Uzstādīšanu, apkopi un ar tīklu saistītos iestatījumus var veikt tikai kvalificēts personāls, kas atbilst šādām prasībām:
  - ir licencēts un/vai atbilst valsts un vietējo tiesību aktu noteikumiem;
  - labi pārzina šo rokasgrāmatu un citus saistītos dokumentus.
3. Pirms ierīces uzstādīšanas rūpīgi izlasiet, pilnīgi izprotiet un stingri ievērojiet lietotāja rokasgrāmatā un citos saistītajos noteikumos sniegtos norādījumus. SolaX neuzņemas atbildību ne par kādām sekām, ko izraisījuši šajā dokumentā un lietotāja rokasgrāmatā noteikto glabāšanas, transportēšanas, uzstādīšanas un ekspluatācijas noteikumu pārkāpumi.
4. Uzstādot šo ierīci, izmantojiet izolētus darbarīkus. Uzstādot, pievienojot elektrībai un veicot apkopi, jāvalkā individuālie aizsarglīdzekļi.
5. Lūdzu, apmeklējiet SolaX tīmekļa vietni [www.solaxpower.com](http://www.solaxpower.com), lai saņemtu sīkāku informāciju.

## Etīķešu apraksts

	CE atbilstības zīme		TUV sertifikācija
	RCM atbilstības zīme		Uzmanību, karsta virsma
	Papildu zemējuma punkts		Uzmanību, bīstamības risks
	Uzmanību, elektriskās strāvas trieciena risks		Neizmetiet invertoru kopā ar sadzīves atkritumiem.
	Izlasiet pievienotos dokumentus		
	Neizmantojiet šo invertoru, ja tas nav izolēts no elektrotīkla un vietējiem saules paneļu ģeneratoriem.		
	Augsta sprieguma radīts apdraudējums. Nepieskarieties strāvu vadošajām daļām 5 minūtes pēc atvienošanas no strāvas avotiem.		

## BĪSTAMI!

Bojāejas risks invertora radīta elektriskās strāvas trieciena dēļ.

- Eksploatējiet inverteru tikai tad, ja tam nav nekādu tehnisku defektu. Pretējā gadījumā var notikt elektriskās strāvas trieciens.
- Nekādā gadījumā neatveriet korpusu bez SolaX atļaujas. Neatļauta atvēršana anulē garantiju un rada bojāejas vai smagu traumu risku elektriskās strāvas trieciena dēļ.

## BRĪDINĀJUMS!

Fizisku ievainojumu vai invertora bojājuma risks

- Eksploatācijas laikā nepieskarieties nekādām citām invertora daļām, izņemot līdzstrāvas slēdzi un LCD paneli.
- Nekad nepievienojiet un neatvienojiet maiņstrāvas un līdzstrāvas kontaktus, kad inverteris darbojas.
- Pirms jebkādu apkopes vai tīrīšanas darbu veikšanas vai arī darba pie jebkuriem pieslēgtajiem kontūriem izslēdziet maiņstrāvas un līdzstrāvas barošanu, atvienojiet to no invertora un pēc tam nogaidiet 5 minūtes, lai spriegums pilnībā izlādētos.
- Pārliecinieties, ka ieejas līdzstrāvas spriegums ir mazāks par vai vienāds ar invertora maksimālo ieejas spriegumu. Pārspriegums var izraisīt neatgriezeniskus invertora bojājumus, ko NESEDŽ garantija.

## UZMANĪBU!

- Sargājiet inverteru no bērniem.
- Pievērsiet uzmanību invertora svaram. Rīkojoties neuzmanīgi, var gūt traumas.

## IEVĒROJIET!











- Ja vietējie noteikumi paredz, ka nepieciešama paliekošās strāvas aizsargierīce (RCD), pārbaudiet, kāda veida RCD ierīce nepieciešama attiecīgajiem elektriskajiem kodiem. Ieteicams izmantot A tipa aizsargierīci ar 300 mA nominālu.
- Visām izstrādājuma etiķetēm un nosaukuma plāksnītei uz invertora jābūt skaidri salasāmām.

## Bezpečnosť

### Všeobecné upozornenia

1. Obsah dokumentu môže byť pravidelne aktualizovaný alebo revidovaný. Spoločnosť SolaX si vyhradzuje právo na akékoľvek zlepšenia a zmeny produktu (produktov) a programu (programov) popísaných v tomto návode bez predchádzajúceho upozornenia.
2. Inštaláciu, údržbu a nastavenie súvisiace so sieťou môže vykonávať len kvalifikovaný personál, ktorý:
  - má licenciu a/alebo spĺňa štátne a miestne právne predpisy,
  - je podrobne oboznámený s týmto návodom a ďalšími súvisiacimi dokumentmi.
3. Pred inštaláciou zariadenia si pozorne prečítajte, plne pochopte a striktno dodržiavajte podrobné pokyny v návode na obsluhu a ďalšie súvisiace predpisy. Spoločnosť SolaX nezodpovedá za žiadne následky spôsobené porušením predpisov týkajúcich sa skladovania, prepravy, inštalácie a prevádzky, ktoré sú uvedené v tomto dokumente a návode na obsluhu.
4. Pri inštalácii zariadenia používajte izolované nástroje. Pri inštalácii, elektrickom zapojení a údržbe je nutné používať osobné ochranné pomôcky.
5. Viac informácií nájdete na webovej stránke spoločnosti SolaX [www.solaxpower.com](http://www.solaxpower.com).

### Popis štítkov

	CE označenie zhody		TUV certifikácia
	RCM označenie zhody		Pozor, horúci povrch
	Dodatočný uzemňovací bod		Pozor, riziko nebezpečenstva
	Pozor, nebezpečenstvo úrazu elektrickým prúdom		Nelikvidujte invertor spolu s komunálnym odpadom.
	Prečítajte si priložené dokumenty		
	Nepracujte na tomto invertore, kým nie je odpojený od hlavnej rozvodnej siete a lokálnych modulov na výrobu fotovoltaickej energie.		
	Nebezpečenstvo vysokého napätia. Nedotýkajte sa častí pod napätím po dobu 5 minút po odpojení od zdroja napájania.		

## NEBEZPEČENSTVO!

### Smrteľné nebezpečenstvo úrazu elektrickým prúdom spôsobené invertorom

- Invertor uvádzajte do prevádzky len vtedy, ak je technicky bezchybný. V opačnom prípade môže dôjsť k úrazu elektrickým prúdom alebo požiaru.
- V žiadnom prípade neotvárajte kryt bez povolenia od spoločnosti SolaX. Neoprávnené otvorenie bude mať za následok stratu záruky a spôsobí smrteľné nebezpečenstvo alebo vážne zranenie v dôsledku úrazu elektrickým prúdom.

## VAROVANIE!

### Nebezpečenstvo poranenia osôb alebo poškodenia invertora

- Počas prevádzky sa nedotýkajte žiadnych častí okrem spínača jednosmerneho prúdu a LCD panela.
- Keď je invertor v prevádzke, nikdy nepripájajte ani neodpájajte konektory jednosmerného a striedavého prúdu.
- Vypnite napájanie striedavým a jednosmerným prúdom a odpojte od nich invertor. Predtým, než pristúpíte k údržbe, čistení alebo práci na akýchkoľvek pripojených obvodoch, počkajte 5 minút, kým sa napätie úplne vybije.
- Uistite sa, že vstupné jednosmerné napätie  $\leq$  maximálne jednosmerné vstupné napätie invertora. Prepätie môže spôsobiť trvalé poškodenie invertora, na ktoré sa NEVŽŤAHUJE záruka.

## POZOR!

- Uchovávajte invertor mimo dosahu detí.
- Venujte pozornosť hmotnosti invertora. Pri nesprávnom zaobchádzaní môže dôjsť k zraneniu osôb.











## UPOZORNENIE!

- Ak miestne predpisy vyžadujú inštaláciu externého prúdového chrániča, overte, ktorý typ prúdového chrániča sa vyžaduje pre príslušné elektrické kódy. Odporúča sa použiť prúdový chránič typu A s citlivosťou 300 mA.
- Všetky produktové štítky a typový štítok na invertore musia byť udržiavané tak, aby boli dobre viditeľné.

## Splošno obvestilo

1. Vsebina se lahko občasno posodablja ali revidira. SolaX si pridržuje pravico do izboljšav ali sprememb v izdelkih in programih, opisanih v tem priročniku, brez predhodnega obvestila.
2. Namestitev, vzdrževanje in nastavitev, povezano z omrežjem, lahko izvaja samo usposobljeno osebje, ki:
  - ima licenco in/ali izpolnjuje državne in lokalne predpise;
  - dobro pozna ta priročnik in druge povezane dokumente.
3. Pred namestitvijo naprave natančno preberite, v celoti razumite in dosledno upoštevajte podrobna navodila uporabniškega priročnika in druge s tem povezane predpise. SolaX ne prevzema odgovornosti za posledice, ki nastanejo zaradi kršitve predpisov o shranjevanju, transportu, namestitvi in delovanju, navedenih v tem dokumentu in uporabniškem priročniku.
4. Pri nameščanju naprave uporabljajte izolirana orodja. Med namestitvijo, električnim priklopom in vzdrževanjem je treba nositi osebna zaščitna orodja.
5. Za več informacij obiščite spletno stran [www.solaxpower.com](http://www.solaxpower.com) podjetja SolaX.

## Opisi nalepk

	Oznaka skladnosti CE		TUV certifikat
	Oznaka skladnosti RCM		Pozor, vroča površina
	Dodatna ozemljitvena točka		Pozor, možna nevarnost
	Pozor, nevarnost električnega udara		Razsmernika ne odlagajte skupaj z gospodinjstvi odpadki.
	Preberite priloženo dokumentacijo		
	Ne uporabljajte tega razsmernika, dokler ni izoliran od električnega omrežja in dobaviteljev fotonapetostne proizvodnje na kraju samem.		
	Nevarnost visoke napetosti. Ne dotikajte se delov pod napetostjo 5 minut po odklopu iz virov napajanja.		

## NEVARNOST!

### Smrtna nevarnost zaradi električnega udara zaradi razsmernika

- Razsmernik uporabljajte le, če je tehnično brezhiben. V nasprotnem primeru lahko pride do električnega udara ali požara.
- V nobenem primeru ne odpirajte ohišja brez dovoljenja družbe SolaX. Nepooblaščenno odpiranje bo razveljavilo garancijo in povzročilo smrtno nevarnost ali resne poškodbe zaradi električnega udara.

## OPOZORILO!

### Nevarnost telesnih poškodb ali poškodb razsmernika

- Med delovanjem se ne dotikajte nobenih delov razen stikala DC, LCD plošče.
- Nikoli ne priklaplajte ali odklapljajte priključkov AC in DC, ko razsmernik deluje.
- Izklopite napajanje izmeničnega in enosmernega toka in ju odklopite iz razsmernika, počakajte 5 minut, da se napetost popolnoma izprazni, preden poskusite vzdrževati, čistiti ali delati na katerem koli priključenem tokokrogu.
- Prepričajte se, da je vhodna enosmerna napetost  $\leq$  največja enosmerna vhodna napetost razsmernika. Previsoka napetost lahko povzroči trajno škodo na razsmerniku, česar garancija NE pokriva.

## POZOR!

- Otroci naj se ne približujejo razsmerniku.
- Bodite pozorni na težo razsmernika. Če z njim ne ravnate pravilno, lahko pride do telesnih poškodb.

## OBVESTILO!











- Če lokalni predpisi zahtevajo zunanji RCD, preverite, kateri tip RCD je zahtevan za ustrezne električne kode. Priporočljivo je, da uporabite RCD tipa A z vrednostjo 300 mA.
- Vse oznake izdelkov in tablica z imenom na pretvorniku morajo biti jasno vidni na razsmerniku.



## Genel Bildirim

1. İçindekiler periyodik olarak güncellenebilir veya revize edilebilir. SolaX, önceden haber vermeksizin ürün(ler) ve bu kılavuzda açıklanan program(lar) üzerinde iyileştirme veya değişiklik yapma hakkını saklı tutar.
2. Kurulum, bakım ve şebekeyle ilgili ayar sadece aşağıdaki özelliklere sahip kalifiye personel tarafından gerçekleştirilebilir:
  - Ulusal ve yerel yasal yetki bölgelerinde lisanslı olmalı ve buralardaki düzenlemelerle uyumlu olmalıdır;
  - Bu kılavuz ve diğer ilgili dokümanlar hakkında iyi bilgiye sahip olmalıdır.
3. Cihazı kurmadan önce kullanım kılavuzunun ve diğer ilgili düzenlemelerin ayrıntılı talimatlarını dikkatlice okuyun, tam olarak anlayın ve kesinlikle uygulayın. SolaX, bu dokümanda ve kullanım kılavuzunda belirtilen depolama, taşıma, kurulum ve işletme düzenlemelerinin ihhalinden kaynaklanan sonuçlardan sorumlu olmayacaktır.
4. Cihazı kurarken yalıtımlı aletler kullanın. Kurulum, elektrik bağlantısı ve bakım sırasında bireysel koruyucu aletler takılmalıdır.
5. Daha fazla bilgi için lütfen [www.solaxpower.com](http://www.solaxpower.com) of SolaX web sitesini ziyaret edin.

## Etiketlerin Açıklamaları

	CE uygunluk işareti		TUV uygunluk işareti
	RCM uygunluk işareti		Dikkat, sıcak yüzey
	Ek topraklama noktası		Dikkat, tehlike riski
	Dikkat, elektrik çarpması riski		İnvertörü evsel atıklarla birlikte atmayın.
	Ekteki dokümanları okuyun		
	Şebeke ve yerinde PV üretimi besleyicilerinden izole edilene kadar bu invertörü çalıştırmayın.		
	Yüksek gerilim tehlikesi. Güç kaynaklarından ayrıldıktan sonra yüklü parçalara 5 dakika boyunca dokunmayın.		

## TEHLİKE!

### İnvertör nedeniyle elektrik çarpması kaynaklı ölümcül tehlike

- İnvertörü yalnızca teknik olarak hatasız olduğunda çalıştırın. Aksi takdirde elektrik çarpması veya yangın meydana gelebilir.
- Muhafazayı hiçbir durumda SolaX'in izni olmadan açmayın. Yetkisiz açılma garantiyi geçersiz kılar ve elektrik çarpması nedeniyle ölümcül tehlikeye veya ciddi yaralanmalara neden olur.

## UYARI!

### Personel yaralanması veya invertör hasarı riski

- Çalışma sırasında DC anahtarı ve LCD panel dışındaki herhangi bir parçaya dokunmayın.
- İnvertör çalışırken AC ve DC konnektörlerini asla bağlamayın veya çıkarmayın.
- AC ve DC gücü kapatın ve invertörden ayırın, bağlı devrelerde herhangi bir bakım, temizlik veya çalışma yapmadan önce gerilimin tamamen boşalması için 5 dakika bekleyin.
- Giriş DC geriliminin invertörün maksimum DC giriş geriliminden az veya buna eşit olduğundan emin olun. Aşırı gerilim invertörde garanti kapsamına girmeyen kalıcı hasara neden olabilir.

## DİKKAT!

- Çocukları invertörden uzak tutun.
- İnvertörün ağırlığına dikkat edin. Doğru şekilde kullanılmazsa kişisel yaralanmalara neden olabilir.

## BİLDİRİ!













- Yerel düzenlemeler tarafından harici bir RCD gerekliyse ilgili elektrik kodları için hangi tür RCD'nin gerekli olduğunu kontrol edin. 300 mA değerinde bir Tip A RCD kullanılması önerilir.
- İnvertördeki tüm ürün etiketleri ve isim plakası açıkça görülebilmelidir.

## Segurança

### Aviso Geral

1. Os conteúdos podem ser periodicamente atualizados ou revistos. A SolaX se reserva o direito de efetuar melhorias ou mudanças no(s) produto(s) e no(s) programa(s) descrito(s) neste manual sem aviso prévio.
2. A instalação, a manutenção e a configuração relativa à rede apenas podem ser realizadas por pessoal qualificado que:
  - É licenciado e/ou satisfaz aos regulamentos das jurisdições estaduais e locais;
  - Tem bons conhecimentos sobre este manual e outros documentos relacionados.
3. Antes da instalação do dispositivo, leia cuidadosamente, entenda totalmente e siga rigorosamente as instruções detalhadas do manual do usuário e de outros regulamentos relevantes. A SolaX será responsável por quaisquer consequências causadas pela violação dos regulamentos de armazenamento, transporte, instalação e regulamentos de operação especificados neste documento e no manual do usuário.
4. Utilize as ferramentas isoladas ao instalar o dispositivo. As ferramentas de proteção individuais devem ser usadas durante a instalação, a conexão elétrica e a manutenção.
5. Por favor visite o site eletrônico [www.solaxpower.com](http://www.solaxpower.com) da SolaX para mais detalhes.

### Descrições dos Rótulos

	Marca CE de conformidade		Certificação TUV
	Marca RCM de conformidade		Atenção, superfície quente
	Ponto de aterramento adicional		Atenção, risco de perigo
	Atenção, risco de choque elétrico		Não descarte o inversor juntamente com resíduos domésticos.
	Leia as documentações em anexo		
	Não opere esse inversor até que ele esteja isolado da rede elétrica e dos fornecedores de geração fotovoltaica no local.		
 	Perigo de alta tensão. Não toque em partes vivas por 5 minutos após a desconexão da fonte de alimentação.		

 PERIGO!

**Perigo de morte por choque elétrico devido ao inversor**

- Somente opere o inversor quando ele não estiver tecnicamente defeituoso. Caso contrário, pode ocorrer choque elétrico ou incêndio.
- Não abra o invólucro em qualquer caso sem autorização da SolaX. A abertura não autorizada violará a garantia e causará perigo de morte ou ferimentos graves devido ao choque elétrico.

 ADVERTÊNCIA!

**Risco de ferimentos pessoais ou danos ao inversor**

- Durante a operação, não toque em nenhuma parte que não seja o interruptor CC e o painel LCD.
- Nunca ligue ou desligue os conectores CA e CC quando o inversor estiver funcionando.
- Desligue a energia CA e CC e desconecte-as do inversor, aguarde por 5 minutos para descarregar totalmente a tensão antes de tentar fazer qualquer manutenção, limpeza ou trabalho em qualquer circuito conectado.
- Certifique-se de que a tensão de entrada CC seja  $\leq$  a tensão de entrada CC máxima do inversor. A sobretensão pode causar dano permanente ao inversor, o que NÃO é coberto pela garantia.

 ATENÇÃO!

- Mantenha-se a criança longe do inversor.
- Preste atenção ao peso do inversor. Os ferimentos pessoais podem ser causados se não forem tratados adequadamente.











AVISO!

- Se um RCD externo for necessário pelos regulamentos locais, verifique em que tipo de RCD é exigido pelos códigos elétricos relevantes. É recomendado usar um RCD do Tipo-A com o valor de 300mA.
- Todos os rótulos e placas de identificação do produto no inversor devem ser mantidos claramente visíveis.

ملاحظات عامة

1. قد تُحدّث المحتويات أو تُراجع بشكل دوري. تحتفظ SolaX بالحق في إجراء تحسينات أو تغييرات في المنتج (المنتجات) والبرنامج (البرامج) الموصوفة في هذا الدليل دون إشعار مسبق.
2. لا يمكن إجراء الإعدادات المتعلقة بالتركيب والصيانة والشبكة إلا بواسطة فنيين مؤهلين:
  - تكون مرخصة و/ أو تتبع لوائح السلطة القضائية الدولية والمحلية.
  - أن تكون لديك معرفة جيدة بهذا الدليل والوثائق الأخرى ذات الصلة.
3. قبل تركيب الجهاز، اقرأ التعليمات التفصيلية لدليل المستخدم واللوائح الأخرى ذات الصلة بعناية وافهمها بالكامل واتبعها بدقة. لن تتحمل SolaX أي مسؤولية عن أي عواقب جراء انتهاك لوائح التخزين والنقل والتركيب والتشغيل المحددة في هذا المستند ودليل المستخدم.
4. استخدم الأدوات المعزولة عند تركيب الجهاز. يجب ارتداء أدوات الحماية الفردية أثناء التركيب والتوصيل الكهربائي والصيانة.
5. يرجى زيارة موقع SolaX على الرابط [www.solaxpower.com](http://www.solaxpower.com) لمزيد من المعلومات.

أوصاف الملصقات

شهادة إدارة السلامة الوظيفية TUV		علامة الامتثال CE	
تحذير! سطح ساخن		علامة الامتثال التنظيمي RCM	
تحذير! خطر محدد		نقطة تأريض إضافية	
لا تتخلص من المحوّل العاكس للتيار مع النفايات المنزلية.		تحذير! خطر حدوث صدمة كهربائية	
		اقرأ الوثائق المرفقة	
لا تقم بتشغيل المحول العاكس للتيار هذا حتى يتم عزله من مزودي التيار الكهربائي وموّل الطاقة الكهروضوئية في الموقع.		خطر الجهد العالي.	
لا تلمس الأجزاء المشحونة بالكهرباء لمدة 5 دقائق بعد فصلها عن مصادر الطاقة.			

### خطراً ⚠️

- خطر الموت من الصدمة الكهربائية بسبب المحوّل العاكس للتيار
- لا تشغّل المحوّل العاكس للتيار إلا عندما يكون بلا عيب تقني. وإلا، فقد تحدث صدمة كهربائية أو حريق.
- لا تفتح الحاوية بأي حال من الأحوال دون تخويل من SolarX. سيؤدي الفتح غير المصرح به إلى إلغاء الضمان ويسبب خطراً مممياً أو إصابة خطيرة بسبب الصدمة الكهربائية.

### تحذيراً ⚠️

- خطر إصابة الأفراد أو تلف المحوّل العاكس للتيار
- لا تلمس أي أجزاء بخلاف مفتاح التيار المستمر ولوحة LCD وغطاء حاوية العاكس أثناء التشغيل.
- لا تقم أبداً بتوصيل أو فصل موصلات التيار المتردد والتيار المستمر في حالة تشغيل المحوّل العاكس للتيار.
- قم بإيقاف تشغيل طاقة التيار المتردد والتيار المستمر وافصلهما عن المحوّل العاكس للتيار، وانتظر لمدة 5 دقائق لتفريغ الجهد بالكامل قبل محاولة أي صيانة أو تنظيف أو العمل على أي دوائر متصلة.
- تأكد من أن جهد دخل التيار المستمر  $\geq$  الحد الأقصى لجهد دخل التيار المستمر للمحوّل العاكس للتيار. قد يتسبب الجهد الزائد في تلف دائم للمحوّل العاكس للتيار، وهو أمر خارج تغطية الضمان.

### تنبيهاً ⚠️

- ابق الأطفال بعيداً عن المحوّل العاكس للتيار.
- انتبه لوزن المحوّل العاكس للتيار. قد تحدث إصابات شخصية إذا لم يتم التعامل معها بشكل صحيح.

### ملاحظة!

- إذا كانت اللوائح المحلية مطلوبة من جهاز تيار متبقي خارجي، فتتحقق من نوع جهاز التيار المتبقي المطلوب للرموز الكهربائية ذات الصلة. يوصى باستخدام جهاز تيار متبقي من النوع (I) بقيمة 300 مللي أمبير.
- يجب الحفاظ على جميع ملصقات المنتج ولوحة الاسم الموجودة على المحوّل العاكس للتيار مرئية بوضوح.

הודעה כללית

1. התוכן עשוי להתעדכן או להשתנות מעת לעת. SOLAX שומרת לעצמה את הזכות לבצע שיפורים או שינויים במוצרים ובתוכניות המתוארות במדריך זה ללא הודעה מוקדמת.
2. ההתקנה, התחזוקה וההגדרות הקשורות לרשת יכולות להתבצע רק על ידי צוות מוסמך אשר:
  - הם בעלי רישיון ו/או עומדים בתקנות המדינה ובתקנות המקומיות;
  - יש להם היכרות טובה עם מדריך זה ועם מסמכים קשורים אחרים.
3. לפני התקנת ההתקן, קרא בעיון, הבן היטב ופעל לפי ההוראות המפורטות במדריך למשתמש ובתקנות קשורות אחרות. SOLAX לא תישא באחריות לכל תוצאה שתיגרם מהפרת תקנות האחסון, ההובלה, ההתקנה והתפעול המפורטות במסמך זה ובמדריך למשתמש.
4. להתקנת ההתקן יש להשתמש בכלים מבודדים. יש ללבוש כלי מגן אישיים במהלך ההתקנה, חיבור החשמל והתחזוקה.
5. למידע נוסף, היכנס לאתר האינטרנט [WWW.SOLAXPOWER.COM](http://WWW.SOLAXPOWER.COM) של SOLAX.

תיאורי תוויות

התעדה של TUV		סימון CE לעמידה בדרישות	
זהירות, משטח חם		סימון RCM לעמידה בדרישות	
זהירות, סכנה		נקודת הארקה נוספת	
אין להשליך את המהפך יחד עם אשפה ביתית.		זהירות, סכנת התחשמלות	
		קרא את התיעוד המצורף	
		אין להפעיל את המהפך כל עוד אינו מבודד מרשת החשמל ומספקים מחוללי מתח פוטו-וולטאי באתר.	
		סכנה, מתח גבוה. אין לגעת בחלקים חיים במשך 5 דקות לאחר הניתוק ממקורות החשמל.	

## סכנה!

### סכנה קטלנית מהלם חשמלי עקב המהפך

- הפעל את המהפך רק לאחר שתוודא שאין בו תקלות טכניות. אחרת, עלולים להתרחש התחשמלות או שריפה.
- אין לפתוח את המארז בשום מקרה ללא אישור של SolaX. פתיחה לא מורשית תבטל את האחריות ותיצור סכנה קטלנית או אפשרות פציעה חמורה עקב התחשמלות.

## אזהרה!

### סכנת פציעה אישית או נזק למהפך

- במהלך הפעולה, אל תיגע בחלקים אחרים מלבד מתג DC וצג LCD.
- לעולם אל תחבר או תנתק מחברי AC ו-DC כאשר המהפך פועל.
- כבה את מתח ה-AC וה-DC ונתק אותם מהמהפך, המתן 5 דקות כדי לפרוק את המתח במלואו לפני שתנסה לבצע תחזוקה, ניקוי או עבודה על מעגלים מחוברים.
- בדוק כדי לוודא שמתח כניסת DC  $\geq$  למתח המרבי של כניסת DC של המהפך. מתח יתר עלול לגרום נזק קבוע למהפך, שאינו מכוסה באחריות.

## זהירות!

- הרחק ילדים מהמהפך.
- שים לב למשקל המהפך. טיפול לקוי עלול לגרום פציעות אישיות.

## שים לב!

- אם התקנות המקומיות מחייבות שימוש בממסר פחת, בדוק איזה סוג של ממסר פחת נדרש על פי תקנות החשמל הרלוונטיות. מומלץ להשתמש בממסר פחת מסוג RCD Type-A בערך 300 mA.
- כל תוויות המוצר ולוחית השם על המהפך יישמרו גליונות בצורה ברורה.



Packing List / Packliste / Liste du matériel livré / Lista de piezas / Lista da embalagem / Paklijst / Contenuto della confezione / Zawartość opakowania / Seznam balení / Packlista / Listă de ambalare / Опаковъчен лист / Pakkeliste / Λίστα συσκευασίας / Pakkeleht / Pakkausluettelo / Popis pakiranja / Csomaglista / Pakuotės turinys / Iepakojuma saraksts / Zoznam položiek balenia / Seznam pakiranja / Kutu Listesi / lista de embalagem / רשימת אריזה / ذئبعتلا قءمءاق

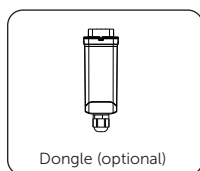
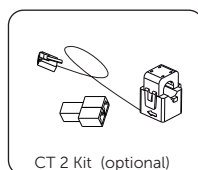
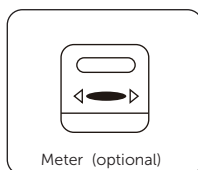
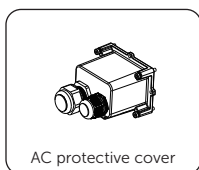
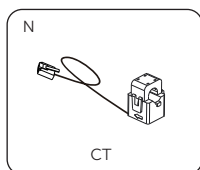
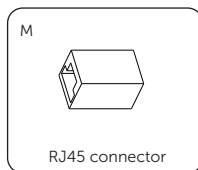
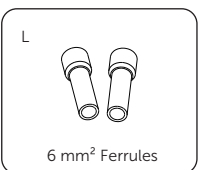
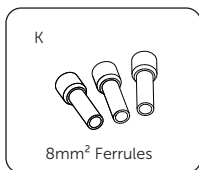
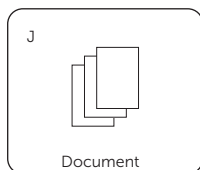
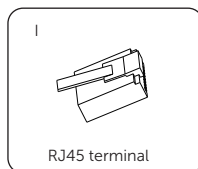
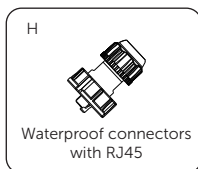
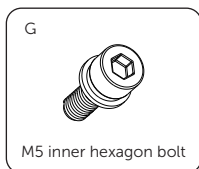
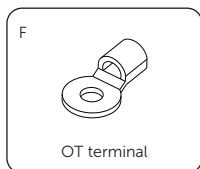
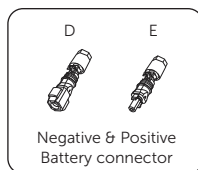
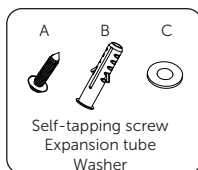
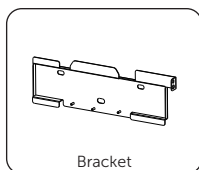
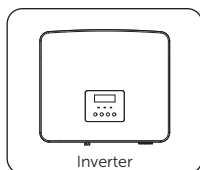

• M series

Item	Description	Quantity
/	Inverter	1 pc
/	Bracket	1 pc
A	Self-tapping screw	3 pcs
B	Expansion tube	3 pcs
C	Washer	3 pcs
D	Negative Battery connector	1 pc
E	Positive Battery connector	1 pc

Item	Description	Quantity
F	OT terminal	1 pc
G	M5 inner hexagon bolt	1 pc
H	Waterproof connector with RJ45	4 pcs
I	RJ45 terminal	1 pc
J	Document	/
/	Dongle (optional)	1 pc

- D series

Item	Description	Quantity
/	Inverter	1 pc
/	Bracket	1 pc
A	Self-tapping screw	3 pcs
B	Expansion tube	3 pcs
C	Washer	3 pcs
D	Negative Battery connector	1 pc
E	Positive Battery connector	1 pc
F	OT terminal	1 pc
G	M5 inner hexagon bolt	1 pc
H	Waterproof connector with RJ45	4 pcs
I	RJ45 terminal	1 pc
J	Document	1 pc
K	8 mm <sup>2</sup> Ferrule	3 pcs
L	6 mm <sup>2</sup> Ferrule	2 pc
M	RJ45 connector	1 pc
N	CT	1 pc
/	AC protective cover	1 pc
/	Meter (optional)	1 pc
/	CT 2 Kit (optional)	1 pc
/	Dongle (optional)	1 pc

- For the optional accessories, please be subject to the actual delivery.

Installation Site / Installationsort / Site d'installation / Sitio de instalación / Local de instalação / Installatiesite / Sito di installazione / Miejsce instalacji / Místo instalace / Installationsplats / Loc de instalare / Монтажен объект / Monteringssted / Τόπος εγκατάστασης / Paigaldamise koht / Asennuspaikka / Lokacija ugradnje / Telepítési helyszín / Montavimo vieta / Uzstādīšanas vieta / Miesto inštalácie / Mesto namestitve / Kurulum Yeri / local de instalação / موقع التركيب / אתר התקנה

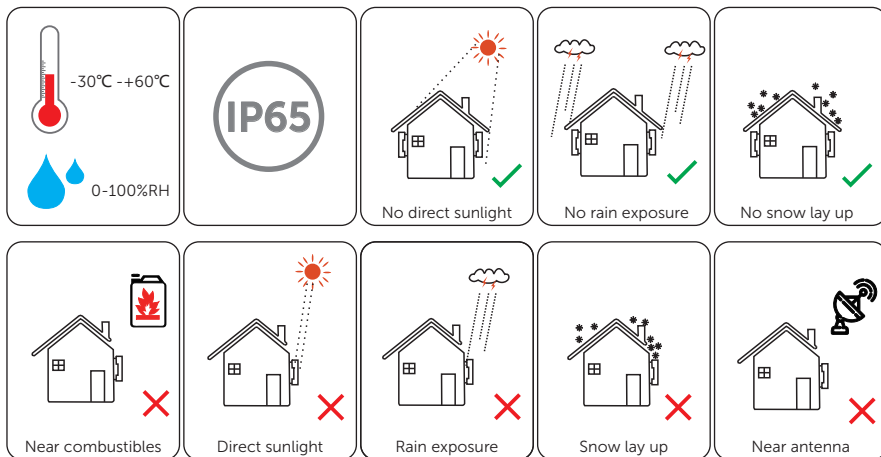

Installation Carrier / Installationsträger / Partie porteuse / Soporte de instalación / Suporte de Instalação / Installatiedrager / Supporto di installazione / Powierzchnia montażowa / Nosič instalace / Installationsfästen / Suport instalație / Монтажна основа / Monteringsholder / Μεταφορέας εγκατάστασης / Paigalduskandja / Asennusteline / Nosač za ugradnju / Telepítési szolgáltató / Montavimo pagrindas / Instalācijas turētājs / Noslāņā konstrukcija pre inštalāciju / Namestitveni nosilec / Kurulum Taşıyıcı / Transportadora de instalação / حامل التثبيت / מנשא התקנה

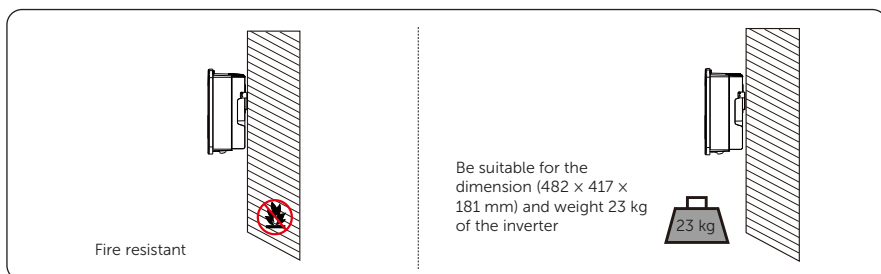

Installation Angle / Installationswinkel / Angle d'installation / Ángulo de instalación / Ângulo de instalação / Installatiehoek / Angolazione di installazione / Kąt instalacji / Installační úhel / Installationsvinkel / Unghi de instalare / Монтажен ъгъл / Monteringsvinkel / Γωνία εγκατάστασης / Paigaldusnurk / Asennuskulma / Kut ugradnje / Telepítési szög / Montavimo kampas / Uzstādišanas leņķis / Uhol inštalácie / Namestitveni kot / Kurulum Açısı / Ângulo de instalação / زوايا التركيب / זווית התקנה

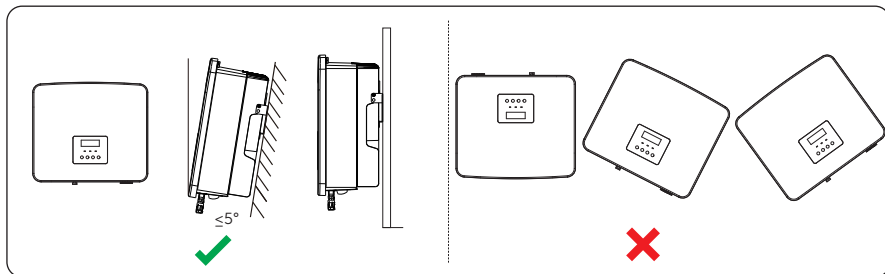

Installation Space / Installationsraum / Espace d'installation / Espacio de instalación / Espaço de instalação / Installierumite / Spazio di installazione / Przestrzeń instalacyjna / Installační prostor / Installationsutrymme / Spațiu de instalare / Монтажно пространство / Monteringsplats / Χώρος εγκατάστασης / Paigaldusruum / Asennustila / Mjesto ugradnje / Telepítési tér / Montavimo erdvė / Uzstādišanas telpa / Priestor pre inštaláciu / Prostor za namestitev / Kurulum Alanı / Espaço de Instalação / مساحة التركيب / שטח התקנה

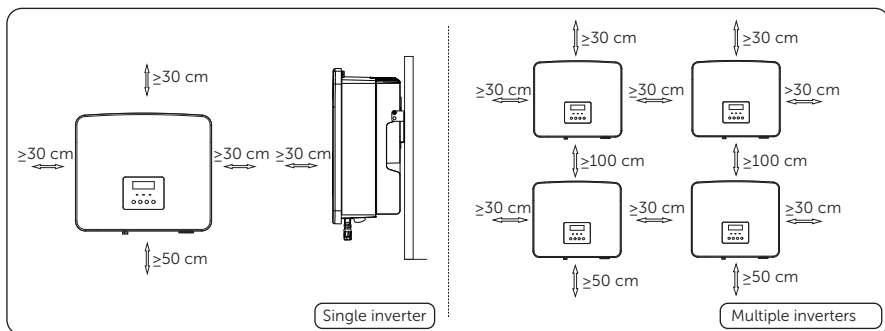

Installation Tools / Installationswerkzeuge / Outils d'installation / Herramientas de instalación / Ferramentas de instalação / Installatiemiddelen / Utensili di installazione / Narzędzia do instalacji / Instalační nástroje / Verktyg för installation / Instrumente de instalare / Монтажни инструменти / Monteringsværktøjer / Εργαλεία εγκατάστασης / Paigaldamise tööriistad / Asennustyökalut / Alati za ugradnju / Telepitő eszközök / Montavimo įrankiai / Uzstādīšanas instrumenti / Nástroje pre inštaláciu / Orodja za namestitev / Kurulum Araçları / Ferramentas de Instalação / أدوات التركيب / כלי התקנה



Hammer drill



Multimeter

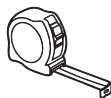

Measuring tape



Utility knife



Marker



Cross screwdriver

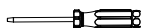

Flat-head screwdriver

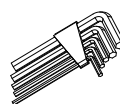

Allen key

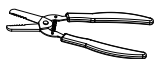

Wire stripper

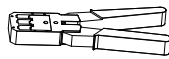

Crimping tool for RJ45

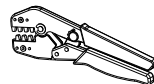

Crimping tool



Diagonal plier

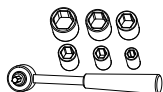

Torque wrench

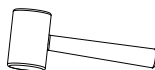

Rubber mallet

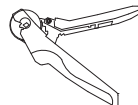

Crimping tool for ferrule

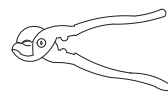

Wire cutter

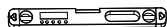

Spirit level

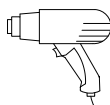

Heat gun

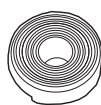

Ø6 mm Heat shrink tubing

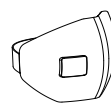

Anti-dust mask



Safety gloves



Safety boots



Safety goggles

Additionally Required Materials / Zusätzlich erforderliche Materialien / Matériaux supplémentaires requis / Materiales adicionales necesarios / Materiais Adicionais Necessários / Extra benodigde materialmen / Materiali aggiuntivi necessary / Materiały wymagane dodatkowo / Další požadované materiály / Ytterligere materialkrav / Materiale suplimentare necesare / Други необходими материали / Yderligere nødvendige materialer / Πρόσθετα απαιτούμενα υλικά / Täiendavad vajalikud materjalid / Muut vaaditud materiaalit / Potrebni dodatni materijali / További szükséges anyagok / Papildomos reikalingos medžiagos / Papildus vajadzīgie materiāli / Dodatno požadované materiály / Dodatno zahtevani materiali / Ayrıca Gerekli Malzemeler / Materiais Adicionais Necessários / المواد المطلوبة أيضًا / חומרים נוספים נדרשים

No.	Required Material	Type	Conductor Cross-section
1	Communication cable	Network cable CAT5e	0.2 mm <sup>2</sup>
2	Additional PE cable	Conventional yellow and green wire	3-4 mm <sup>2</sup>

- Grid Cable and Micro-breaker recommended

Model	X1-Fit-3.7-W	X1-Fit-5.0-W X1-Fit-5.0K-W	X1-Fit-6.0-W	X1-Fit-7.5-W
Three-core copper wire	6-8 mm <sup>2</sup>	8-10 mm <sup>2</sup>	8-10 mm <sup>2</sup>	8-10 mm <sup>2</sup>
Micro-breaker	40 A	50 A	50 A	50 A

Model	X1-Fit-3.7-M	X1-Fit-5.0-M	X1-Fit-6.0-M	X1-Fit-7.5-M
Three-core copper wire	3-4 mm <sup>2</sup>	4-6 mm <sup>2</sup>	4-6 mm <sup>2</sup>	6-8 mm <sup>2</sup>
Micro-breaker	25 A	32 A	32 A	32 A

- EPS (Off-grid) Cable and Micro-breaker recommended

Model	X1-Fit-3.7-W X1-Fit-3.7-M	X1-Fit-5.0-W X1-Fit-5.0K-W X1-Fit-5.0-M	X1-Fit-6.0-W X1-Fit-6.0-M	X1-Fit-7.5-D X1-Fit-7.5-M
Two-core copper wire	3-4 mm <sup>2</sup>	4-6 mm <sup>2</sup>	4-6 mm <sup>2</sup>	6-8 mm <sup>2</sup>
Micro-breaker	25 A	32 A	32 A	40 A

- Lead-acid battery breaker recommended

Model	X1-Fit-3.7-W X1-Fit-3.7-M	X1-Fit-5.0-W X1-Fit-5.0K-W X1-Fit-5.0-M	X1-Fit-6.0-W X1-Fit-6.0-M	X1-Fit-7.5-D X1-Fit-7.5-M
Voltage	Nominal voltage of DC breaker should be larger than maximum voltage of battery.			
Current	32 A			

Mechanical Installation / Mechanische Installatie / Installation mécanique / Instalación mecánica / Instalação mecânica / Mechanische installatie / Installazione meccanica / Instalacja mechaniczna / Mechanická instalace / Mekanisk installation / Μηχανική εγκατάσταση / Mehaaniline paigaldus / Mekaaninen asennus / Mehanička ugradnja / Mechanikai telepítés / Mechaninis montavimas / Mehāniskā uzstādīšana / Mechanická inštalácia / Mehanska namestitvev / Mekanik Kurulum / Instalação Mecânica / التركيب الميكانيكي / התקנה מכנית

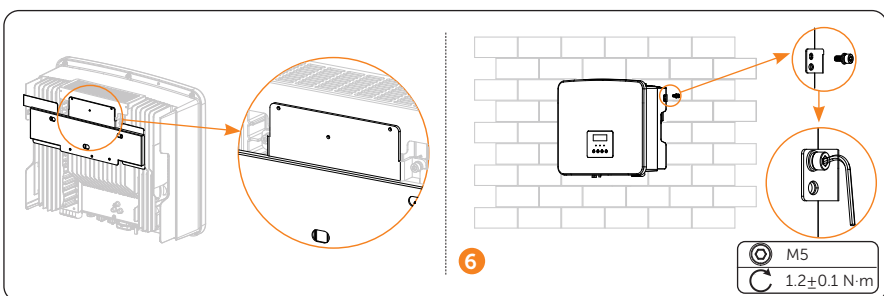
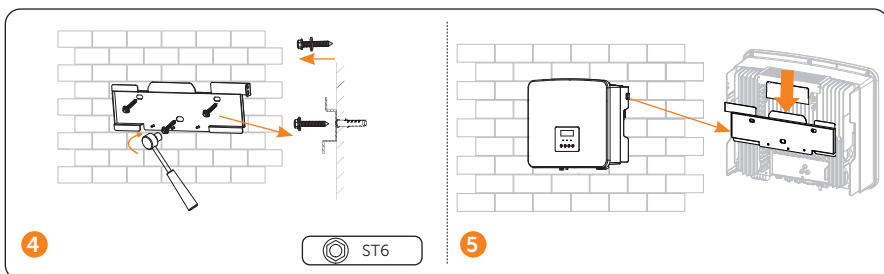
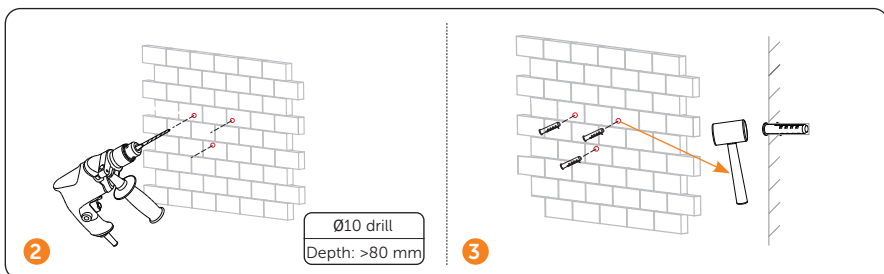
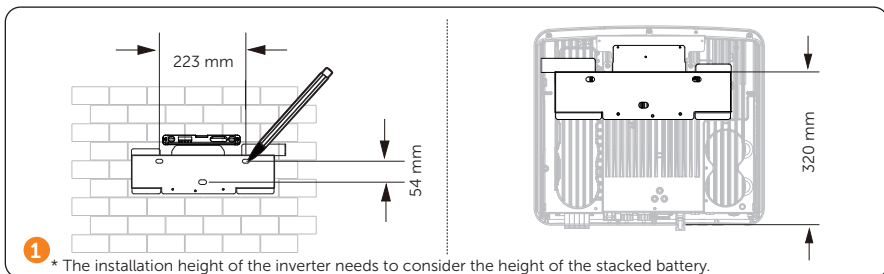

PE Connection / Schutzerdungs-Anschluss / Connexion PE / Conexión PE / Ligação à Terra / PE-aansluiting / Collegamento PE / Połączenie PE / PE připojení / PE-anlutning / Conexiune PE / PE връзка (земя) / Jordforbindelse / Σύνδεση PE / PE ühendus / PE-yhteys / PE priključak / PE bekötés / PE (apsauginio įžeminimo) kontaktas / PE savienojums / Pripojenie ochranného vodiča / PE povezava / PE Bağlantısı / Conexão PE / חיבור פוטו-אלקטרי / توصيل (الارضى الوقائي) PE

The ground wire port of M series inverter has been connected, and the W series needs to be wired according to the following steps.

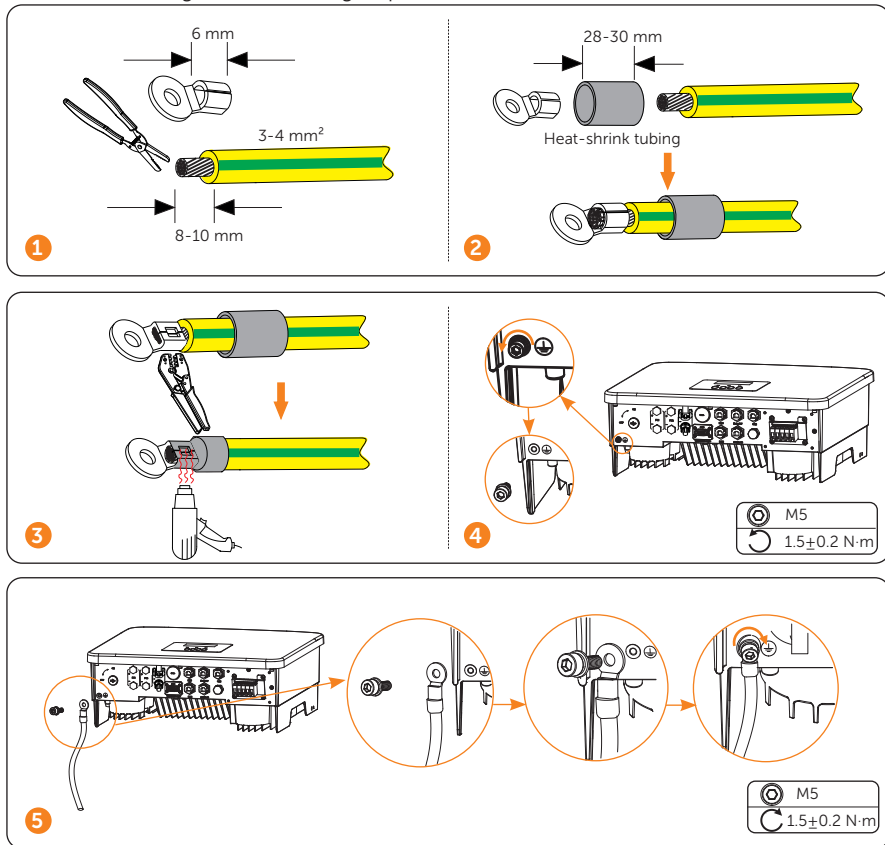



Grid and EPS (Off-grid) Connection / Netz- und EPS (netzunabhängig)-Verbindung / Branchement Réseau et EPS (Hors-réseau) / Conexión de red y EPS (fuera de la red) / Ligação à Rede e Off-grid (fora da rede) / Aansluiting op het net en EPS (niet aangesloten op het net) / Collegamento GRID e EPS (off-grid) / Połączenie z siecią i EPS (off-grid) / Připojení k síti a EPS (off-grid) / Elnäts- och EPS-anslutning (utanför elnätet) / Conectare la rețea și EPS (în afara rețelei) / Връзка с мрежата и аварийното захранване (автономно) / Elnet- og EPS-tilslutning (uden for elnettet) / Σύνδεση στο δίκτυο και σε Σύστημα ηλεκτρικής ενέργειας (EPS) (εκτός δικτύου) / Võrgu- ja EPS- (võrgust väljas) ühendus / Verkon ja EPS:n (Off-grid) liitäntä / Priključak mreže i EPS priključak (izvan mreže) / Rácsos és EPS (rácson kívüli) bekötés / Tinklo ir EPS (neprijungto prie tinklo) jungtis / Tikla un EPS (ārpustikla) savienojums / Pripojenie do siete a k núdzovému napájaniu EPS (mimo siete) / Povezava z omrežjem in EPS zasilno napajanje (izven omrežja) / Şebeke ve EPS (Şebeke Dışı) Bağlantı / Conexão de Rede e EPS (Fora da rede) / חיבור רשת ו-EPS (מחוץ לרשת) / اتصال الشبكة و EPS (خارج الشبكة)

The Grid and EPS (Off-grid) ports of M series inverter have been connected, and the W series needs to be wired according to the following steps.

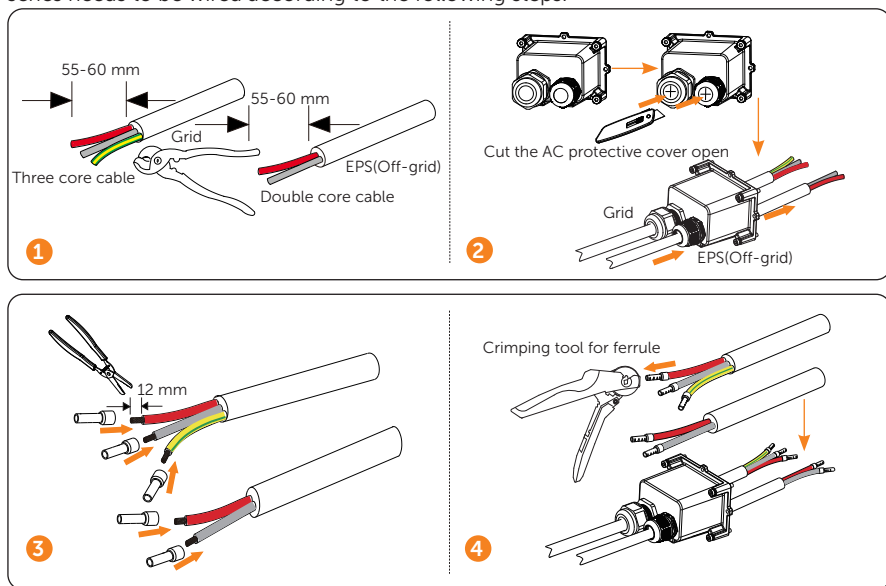

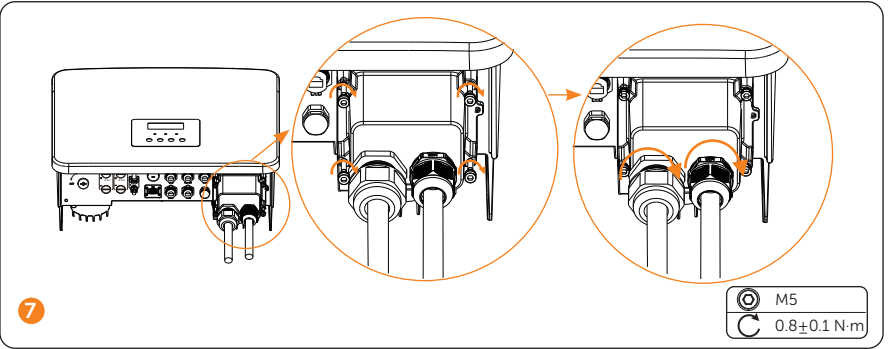
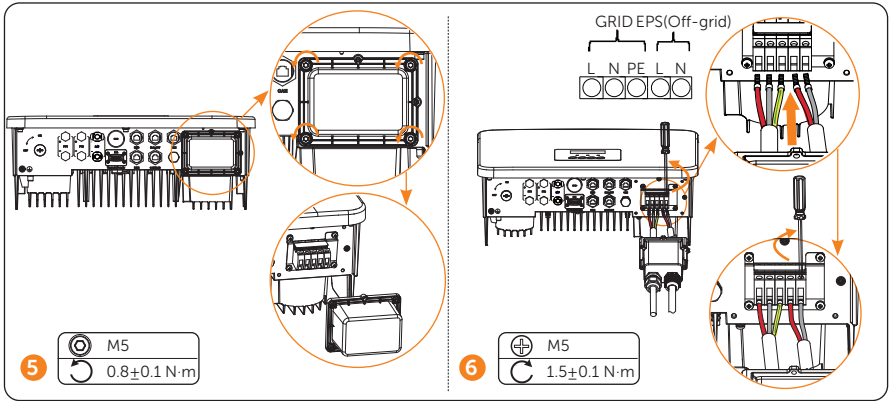

Battery Connection / Batterieanschluss / Branchement de la batterie / Conexión de la batería / Ligaçáo da bateria / Batterij-aansluiting / Collegamento della batteria / Połączenie akumulatora / Pripojení baterie / Batterianslutning / Conectare baterie / Връзка с батерията / Batteritilslutning / Σύνδεση μπαταρίας / Akkuühendus / Akun liitântä / Priključak za bateriju / Akkumulátor bekötés / Akumulatoriaus jungtis / Akumulatora savienojums / Pripojenie batérie / Povezava baterije / Akü Bağlantısı / Conexão da Bateria / חיבור סוללה / اتصال الكهروضوئية

- Battery connection diagram

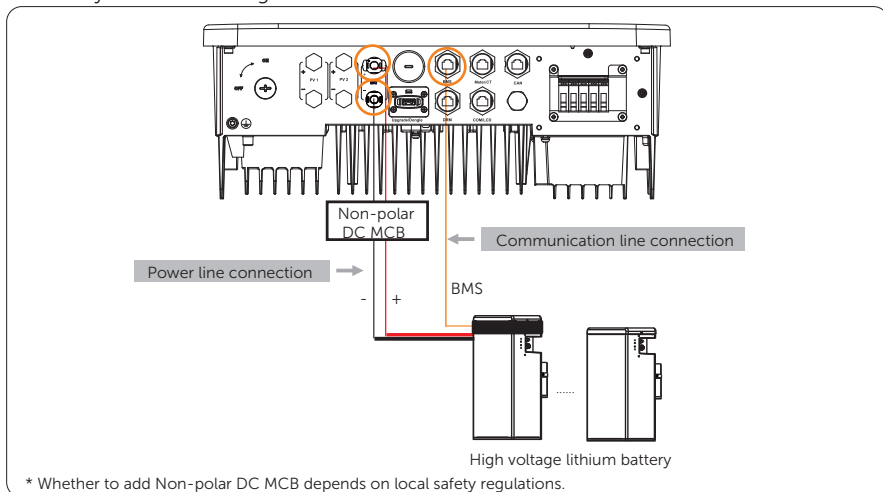

	Battery Control	Battery Modules
Battery & Quantity	T-BAT 5.8 (1 PCS)	HV11550 (0-2 PCS)
Battery & Quantity	MC0600 (1 PCS)	HV10230 (1-4 PCS)
Battery & Quantity	TBMS-MCR0800 (1 PCS)	TP-HR25 (2~8 PCS)
Battery & Quantity	TBMS-MCR0800 (1 PCS)	TP-HR36 (2~8 PCS)
Battery & Quantity	TBMS-MCS0800 (1 PCS)	TP-HS25 (2~8 PCS)
Battery & Quantity	TBMS-MCS0800 (1 PCS)	TP-HS36 (2~8 PCS)

\* T58 battery has V1 and V2, V1 and V2 with the same number of inverters, the specific collocation can refer to the relevant part of the battery manual.

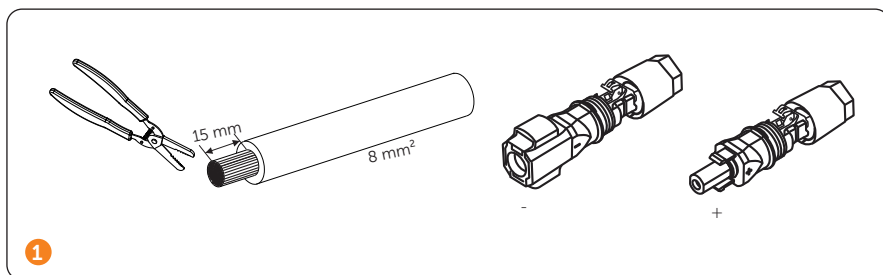

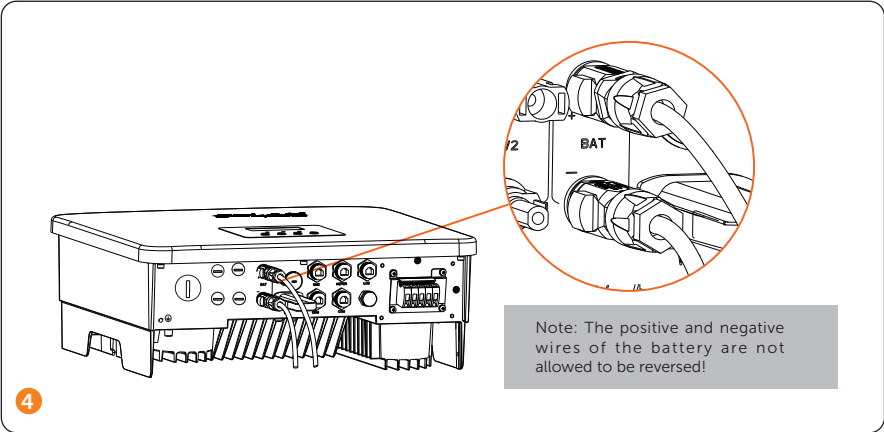
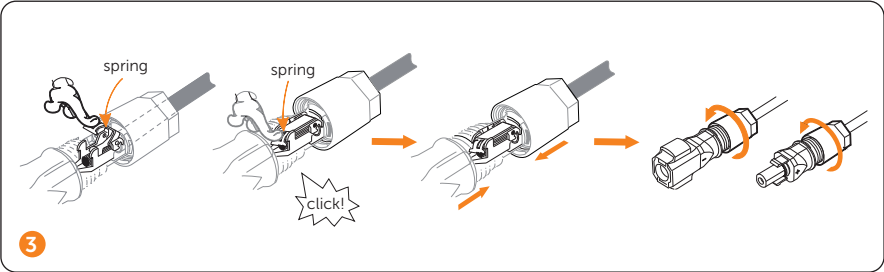
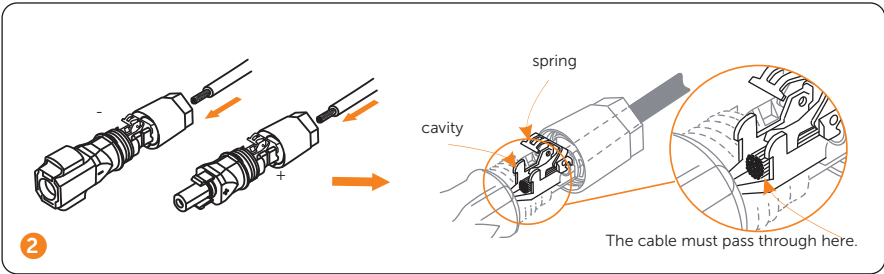

Communication Connection / Kommunikations-Anschluss / Branchement de communication / Conexión de comunicaci3n / Ligaç3o à Comunicaç3o / Communicatie-aansluiting / Collegamento comunicazione / Połączenie komunikacyjne / Komunikační pøípojení / Kommunikationsanslutning / Conexiune de comunicare / Коммуникационная вøязка / Kommunikationsforbindelse / Σύνδεση επικοινωνίας/Sideühendus / Tiedonsiirtoliitântä / Pøikljuèak za komunikaciju / Kommunikaci3s bek3t3s / Duomenų ryšys / Sakaru savienojums / Pøípojenie komunikácie / Komunikacijska povezava / İletişim Baęlantısı / Conex3o do Cabo de Comunicaç3o / اتصال البطارية / חיבור תקשורת

- CT/Meter port connection

1. CT connection diagram

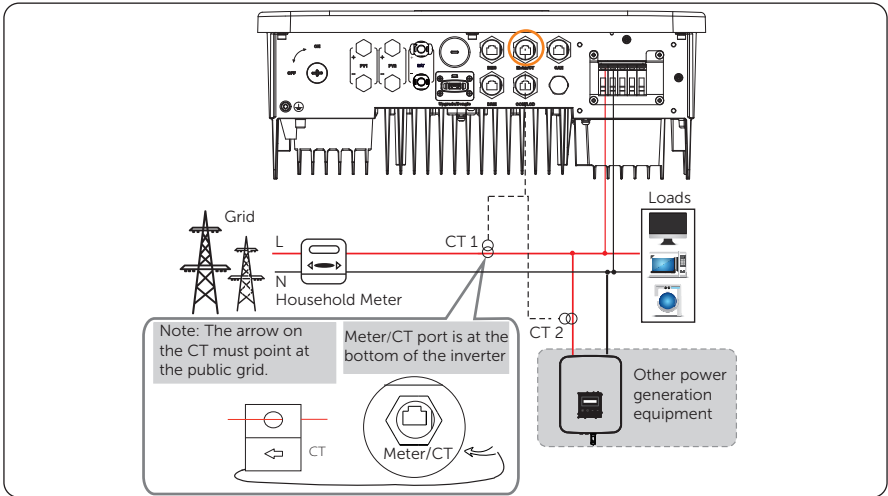

2. Meter connection diagram

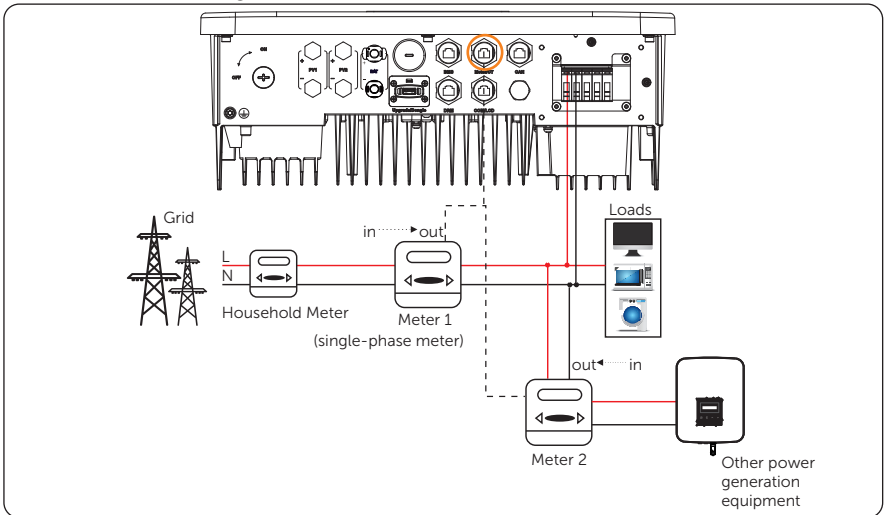

\* If two meters were to be connected in the system, the communication cables of the meters should be connected in parallel, i.e. 485A & 485A, 485B & 485B.

### 3. Pin definition for CT/Meter

Pin	1	2	3	4	5	6	7	8
Pin Definition	CT1-1	X	CT2-1	485A	485B	CT2-2	X	CT1-2

\* Only one of the Meter and CT connections can be selected. Meter cable goes to pin terminal 4 and 5; CT cable goes to pin terminal 1 and 8; reserve CT cable goes to pin terminal 3 and 6.

### 4. CT/Meter connection steps

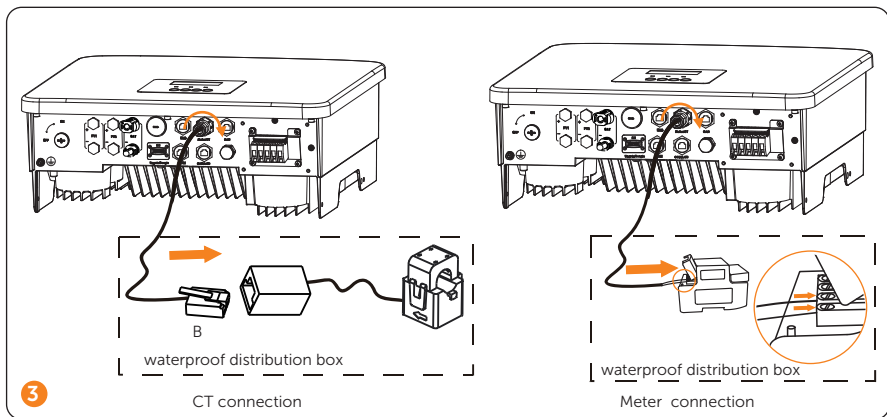
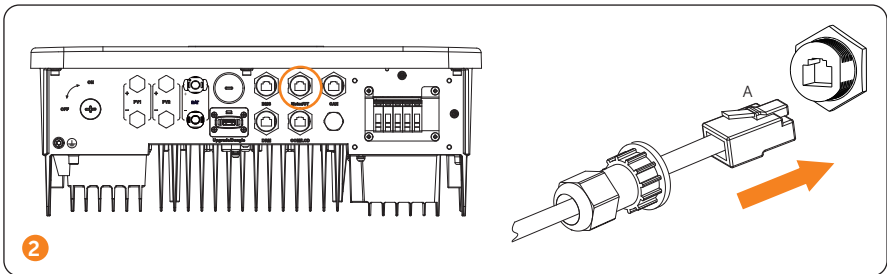
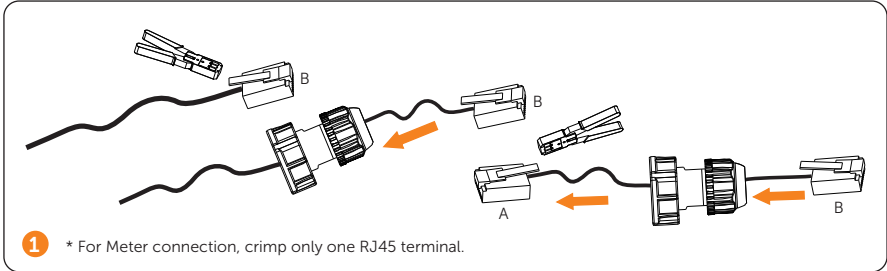

- **BMS/DRM/CAN/COM/LCD port connection**

1. Pin definition for BMS

Pin	1	2	3	4	5	6	7	8
Pin Definition	BAT_TEMP	GND	GND	BMS_CANH	BMS_CANL	X	BMS-485A	BMS_485B

\* The communication port on the lithium battery must be consistent with the definition of pins 4, 5, 7, and 8 above.

2. Pin definition for DRM

Pin	1	2	3	4	5	6	7	8
Pin Definition	DRM1/5	DRM2/6	DRM3/7	DRM4/8	+3.3V	DRM0 (ShutDown)	GND	GND

\* For AS4777 DRM, only PIN6 (DRM0) and PIN1 (DRM1/5) are functional now.

3. Pin definition for CAN

Pin	1	2	3	4	5	6	7	8
Pin Definition	485A	485B	VCC	CANH	CANL	GND	SYN1	SYN2

4. COM/LCD

4.1 Pin definition for COM/LCD

Pin	1	2	3	4	5	6	7	8
Pin Definition	Drycontact_A (in)	Drycontact_B (in)	+12V	485A	485B	GND	Drycontact_A (out)	Drycontact_B (out)

\* You can communicate the inverter and external devices through the COM interface. Professional users can use pins 4 and 5 to realize data acquisition and external control functions. The communication protocol is modbus RTU.

\* When the ShutDown function is enabled, connecting pins 1 and 2 can shut down the inverter. (Settings <Password 2014> → Advance Settings→ ShutDown→ Enable)

4.2 Situation of external equipment controlled by the inverter

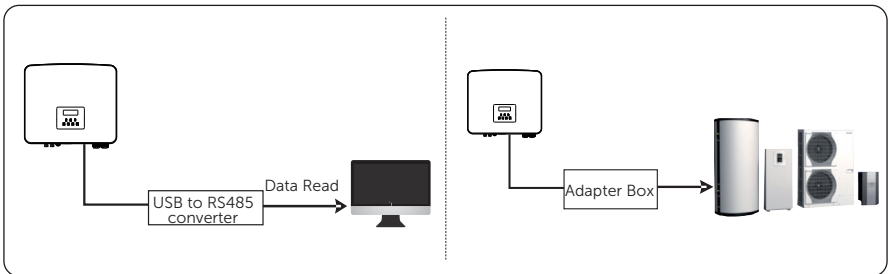

## 5. BMS/DRM/CAN/COM/LCD connection steps

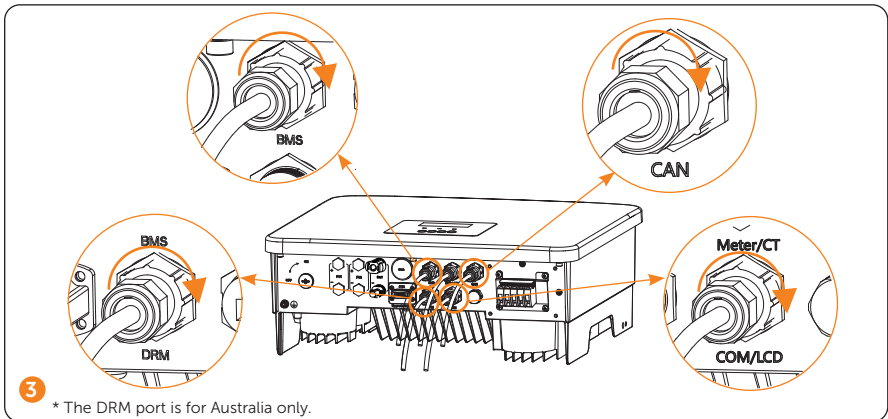
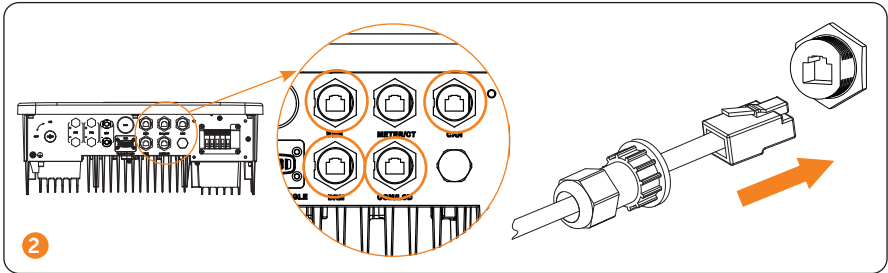
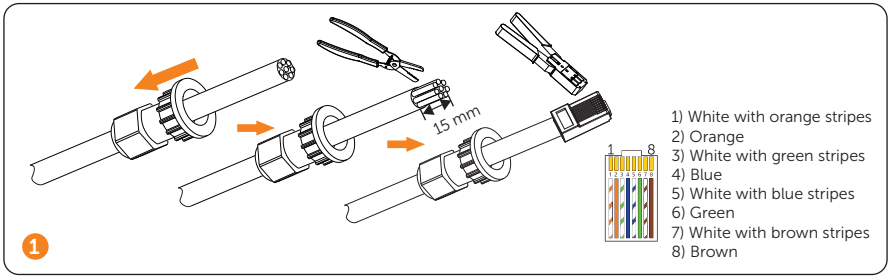



Monitoring Connection / Überwachungs-Anschluss / Branchement de surveillance / Conexión de monitorización / Ligação à Monitorização / Monitoring-aansluiting / Collegamento monitoraggio / Połączenie na potrzeby monitorowania / Připojení ke sledování / Övervakningsanslutning / Conexiune de monitorizare / Мониторингова връзка / Övervakningsforbindelse / Σύνδεση παρακολούθησης / Seire ühendus / Valvontaliitäntä / Priključak za nadzor / Monitoring bekötés / Stebėjimo ryšys / Uzraudzības savienojums / Pripojenie monitorovania / Povezava za spremljanje / İzleme Bağlantısı / Conexão de Monitoramento / مراقبة الاتصال / חיבור ניטור

WiFi Mode:

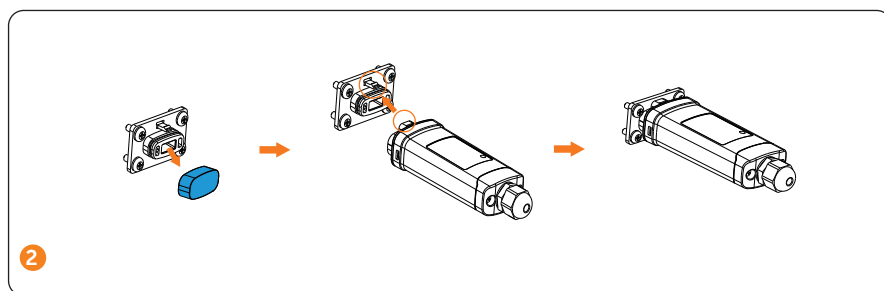
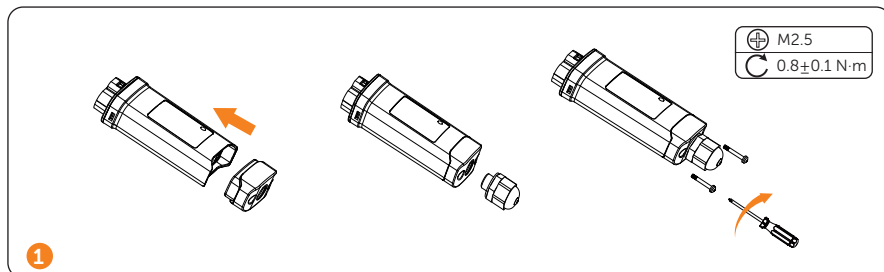

LAN Mode:

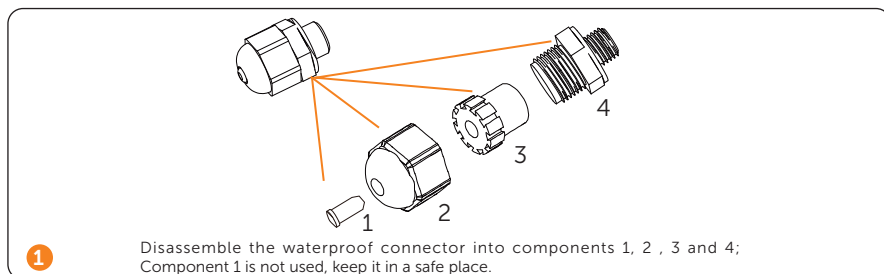

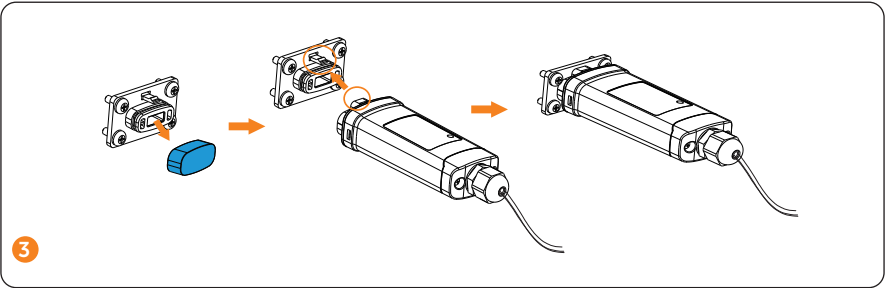
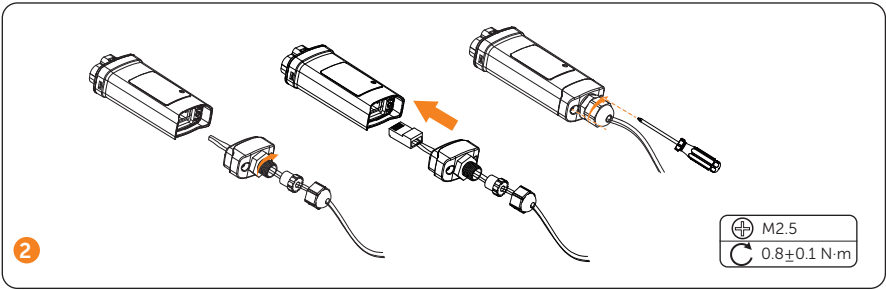

Power on the System / Schalten Sie das System ein / Mise sous tension du système / Encienda el sistema / Ligue o sistema / Het systeem inschakelen / Accensione del sistema / Włączanie systemu / Zapnutí systému / Slå på systemet / Pornire sistem / Включване на системата / Tænd for systemet / Ρεύμα στο σύστημα / Süsteemi sisselülitamine / Kytke järjestelmän virta päälle / Napajanje sustava / Rendszer áram alá helyezésé / Įjungti sistemą / Ieslēdziet sistēmu / Zapnite system / Vklõpote sistem / Güç açma / Ligar o Sistema / חיבור ניטור / قم بتشغيل النظام

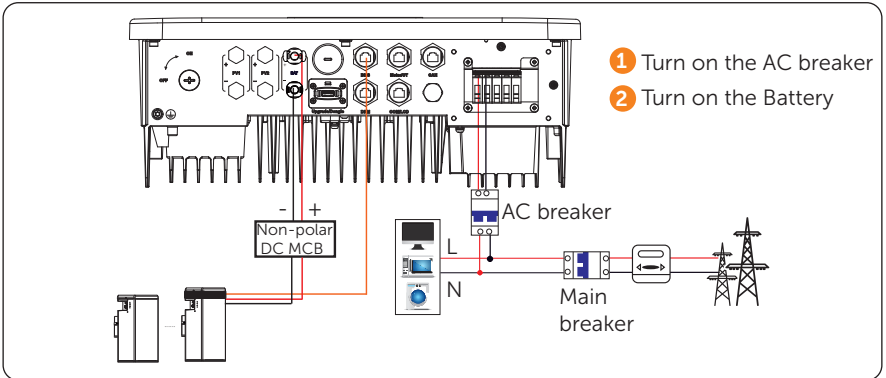

LCD Panel / LCD-Bildschirm / Panneau LCD / Panel LCD / Painele de LCD / LCD-paneel / Pannelo LCD / Panel LCD / LCD panel / LCD-paneel / Panou cu LCD / LCD панель / LCD-paneel / Πάνελ LCD / LCD-paneel / LCD-paneeli / LCD ploča / LCD panel / LCD skydas /LCD panelis / LCD Panel / LCD plošča / LCD Panel / Painele LCD / **LED** لوحة LED / **LCD** ليد

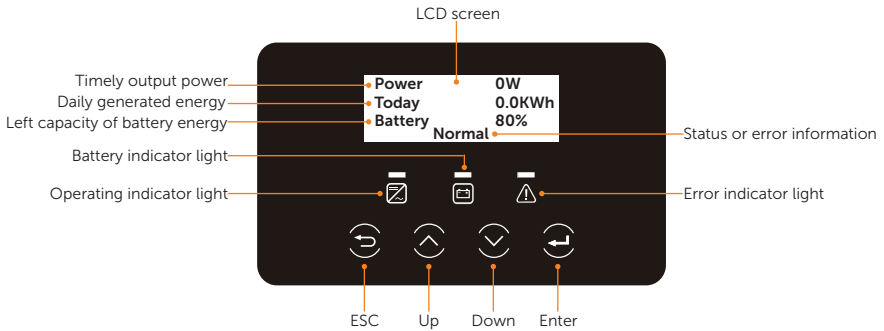

- In normal state, the "Power", "Today" and "Battery" information will be displayed. You can press the keys to switch information.
- In error state, the fault message and error code will be displayed, please refer to corresponding solutions in the user manual.

Item	Definition
LCD screen	Display the information of the inverter.

LED indicator	Definition
	Light in blue: The inverter is in normal status or EPS (Off-grid) mode. Flash in blue: The inverter is in waiting, checking status or the system switch is off. Light off: The inverter is in fault status.
	Light in green: The battery communication is in normal status and working normally. Flash in green: The battery communication is in normal status and in an idle status. Light off: The battery does not communicate with the inverter.
	Light in red: The inverter is in fault status. Light off: The inverter is in normal status.

Key	Definition
ESC key	Exit from the current interface or function
Up key	Move the cursor to the upper part or increase the value
Down key	Move the cursor to the lower part or decrease the value
Enter key	Confirm the selection

General Setting / Allgemeine Einstellungen / Paramètres généraux / Configuración general / Definição Geral / Algemene instelling / Impostazione generale / Ustawienia ogólne / Obecné nastavení / Generell inställning / Setare general / **Обща настройка** / Genel indstilling / Γενική τοποθέτηση / Üldine seadistus / Yleisasetus / Opće postavke / Általános beállítás / Bendrasis nustatymas / Vispārīgs iestatījums / Všeobecné nastavenie / Splošna nastavitve / Genel Ayar / Configuração Geral / הגדרה כללית / الإعداد العام

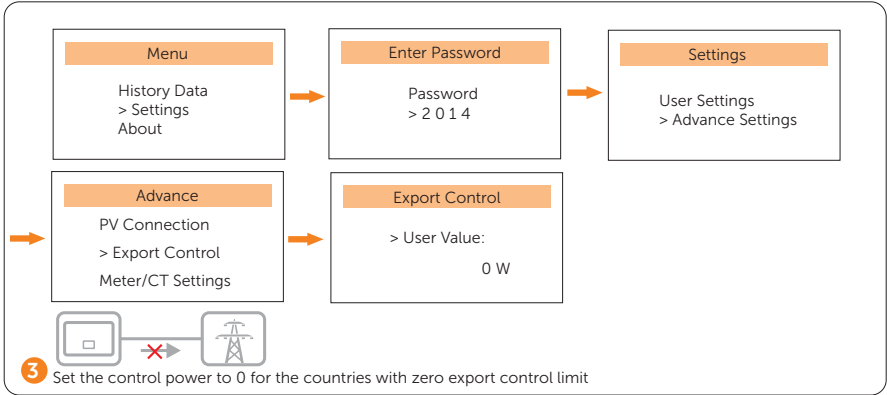
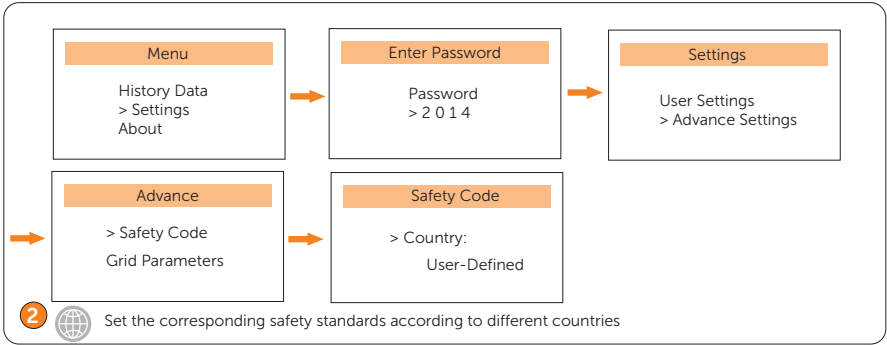
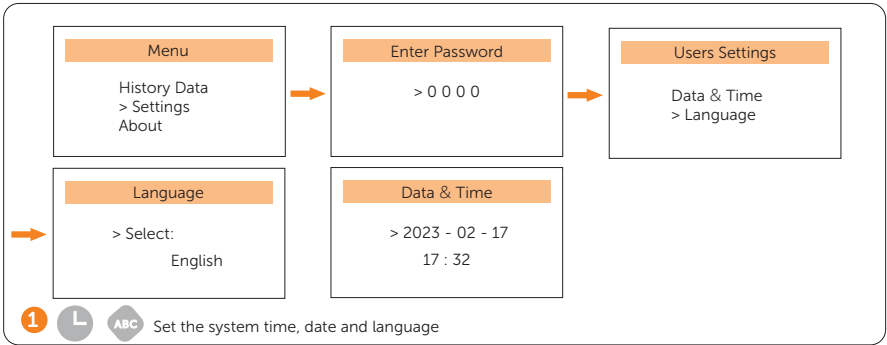

\* The initial password is 1204 which should be changed for the consideration of account security.

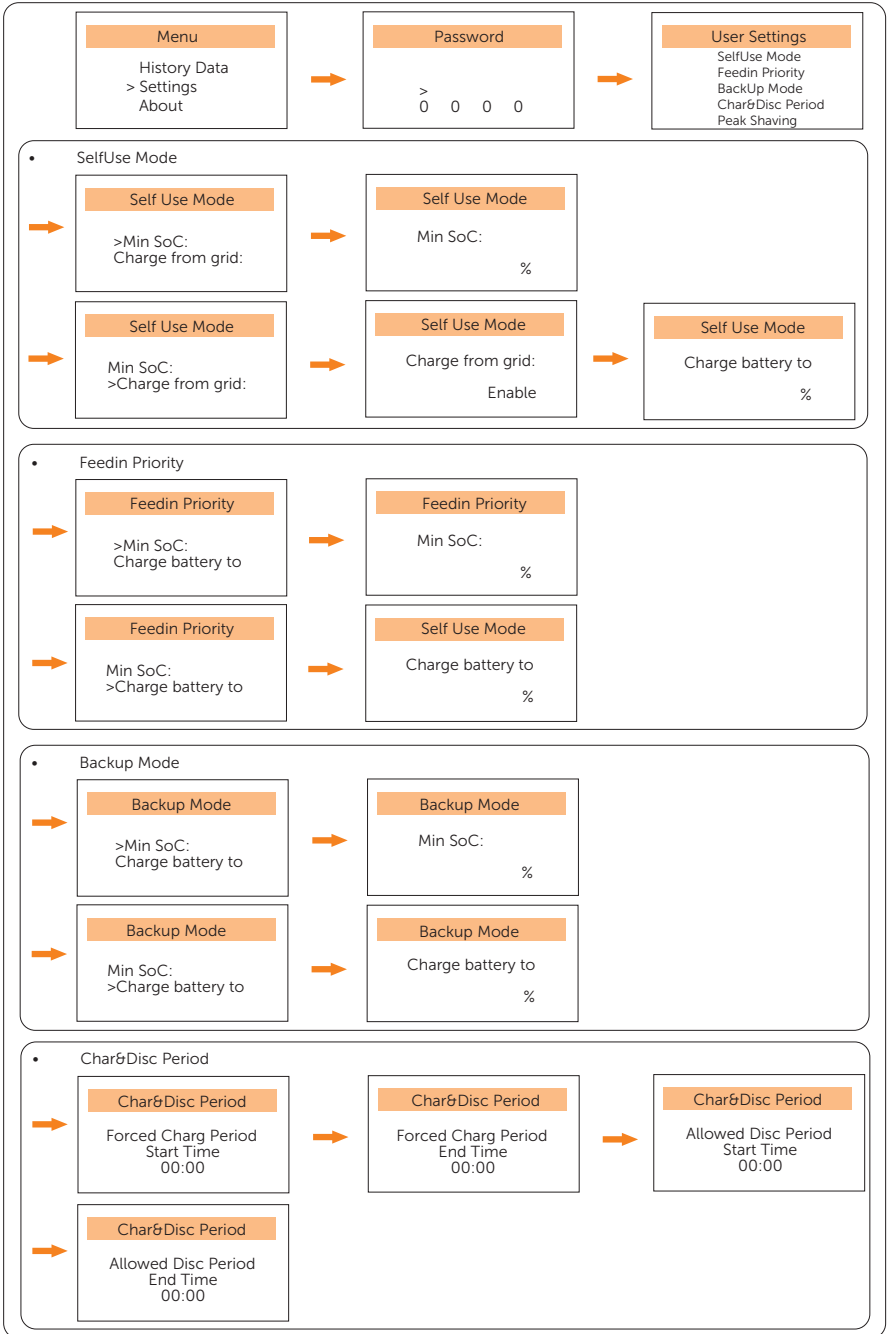

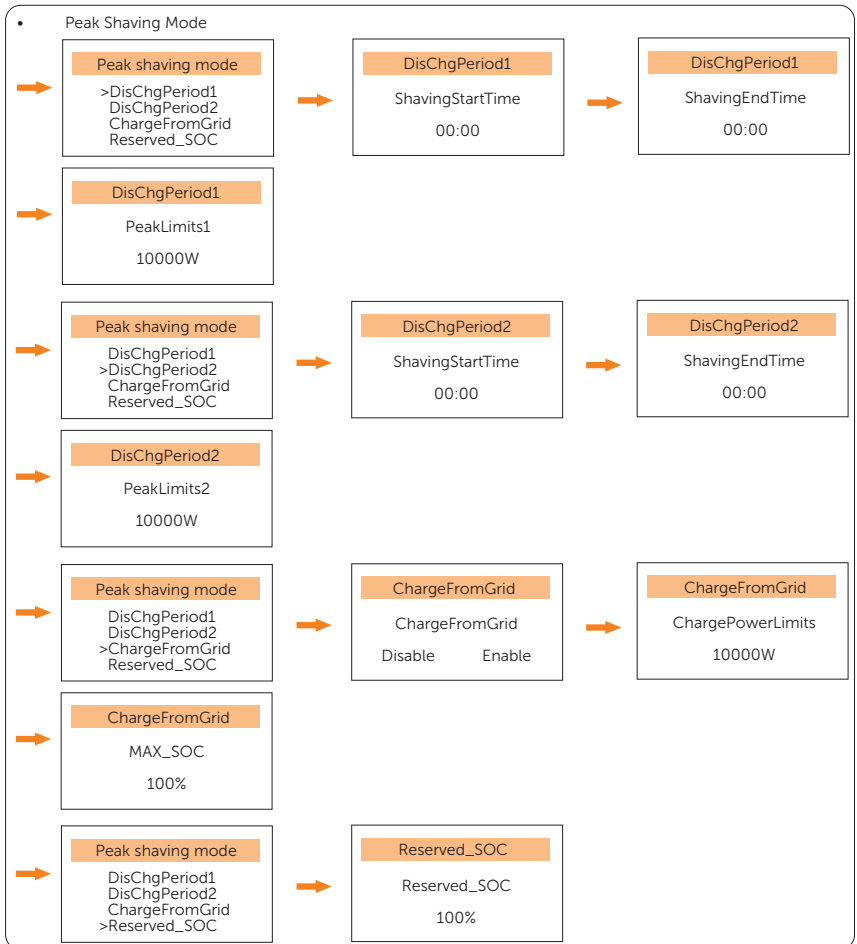
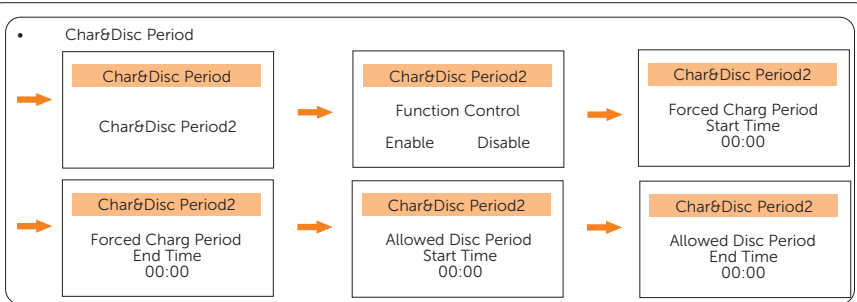

4 Set the working mode.

Wi-Fi Configuration / WLAN-Konfiguration / Configuration Wi-Fi / Configuración de wifi / Configuração de Wi-Fi/Wi-Fi-configuratie / Configurazione del Wi-Fi / Konfiguracja Wi-Fi / Konfigurace Wi-Fi / Wi-Fi-konfiguration / Configurare Wi-Fi / Wi-Fi конфигурация / Wi-Fi-konfiguration / Ρυθμίσεις παραμέτρων Wi-Fi / Wi-Fi konfiguratsioon / Wi-Fi-kokoonpano / Konfiguracija Wi-Fi mreže / Wi-Fi konfiguráció / „Wi-Fi“ konfiguracija / Wi-Fi konfigurácia / Konfigurácia Wi-Fi / Konfiguracija Wi-Fi / Wi-Fi Yapılandırması / Configuração Wi-Fi / تكوين واي فاي / תצורת Wi-Fi

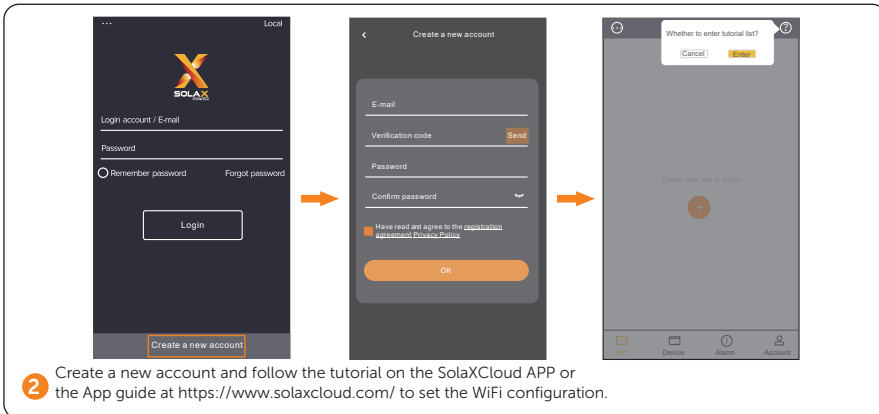

Technical Data / Technische Daten / Fiche technique / Datos técnicos / Dados Técnicos / Technische gegevens / Dati tecnici / Dane techniczne / Technické údaje / Techniska data / Date tehnice / Технически данни / Tekniske data / Τεχνικά δεδομένα / Tehnilised andmed / Tekniset tiedot / Tehnički podaci / Műszaki adatok / Techniniai duomenys / Tehniskie dati / Technické údaje / Tehnični podatki / Teknik Bilgiler / Dados Técnicos / נתונים טכניים / البيانات الفنية

• AC output/ input

Model	X1-Fit-3.7-W X1-Fit-3.7-M	X1-Fit-5.0-W X1-Fit-5.0K-W X1-Fit-5.0-M	X1-Fit-6.0-W X1-Fit-6.0-M	X1-Fit-7.5-W X1-Fit-7.5-M
<b>AC output</b>				
Rated output apparent power [VA]	3680	5000w (Germany 4600, AU 4999) (5.0K-W 4999)	6000	7500
Max. output apparent power [VA]	3680	5500 (Germany 4600, AU 4999) (5.0K-W 4999)	6600	7500
Nominal AC voltage [a.c. V]	220/230/240 (180 to 270)			
Frequency [Hz]	50/60			
Rated output current [a.c. A]	16	21.7	26.1	32.6
Max. output continuous current [a.c. A]	16	23.9 (Germany 20, AU 21.7)	28.6	32.6
Current (inrush) (at 50µs) [a.c. A]	10			
Maximum output fault current (at 1ms) [a.c. A]	91			
Maximum output overcurrent protection [a.c. A]	65			
Power factor range	0.8 leading - 0.8 lagging			
Total harmonic distortion (THDi)	< 2 %			
<b>AC input</b>				
Max. apparent power [VA]	7360	9200	9200	9200
Rated AC power [W]	3680	5000	6000	7500
Rated grid voltage range [a.c. V]	220/230/240 (180 to 270)			
Rated grid frequency [Hz]	50/60			
Max. AC current [a.c. A]	32	40	40	40
Power factor range	0.8 leading - 0.8 lagging			

• Battery

Model	X1-Fit-3.7-W X1-Fit-3.7-M	X1-Fit-5.0-W X1-Fit-5.0K-W X1-Fit-5.0-M	X1-Fit-6.0-W X1-Fit-6.0-M	X1-Fit-7.5-W X1-Fit-7.5-M
Battery type	Lithium batteries			
Battery voltage range [d.c. V]	80-480			
Max. continuous charge/ discharge current [d.c. A]	30			
Communication interface	CAN/RS485			
Reverse connection protection	Yes			



- Efficiency, Safety and Protection

Model	X1-Fit-3.7-W X1-Fit-3.7-M	X1-Fit-5.0-W X1-Fit-5.0K-W X1-Fit-5.0-M	X1-Fit-6.0-W X1-Fit-6.0-M	X1-Fit-7.5-W X1-Fit-7.5-M
<b>Efficiency</b>				
Max. battery charge efficiency (AC to BAT) (@ full load)	97.0%	97.0%	97.0%	97.0%
Max. battery discharge efficiency (BAT to AC) (@ full load)	97.0%	97.0%	97.0%	97.0%
<b>Safety and Protection</b>				
Safety	EN/IEC 62109-1/-2			
Grid monitoring	VDE-AR-N 4105, G99, G98, AS/NZS 4777, EN50549, CEI 0-21, C10/11, IEC61727, RD1699, NRS 097-2-1, PEA/MEA, VFR2019, PPDS			
AC SPD protection	Integrated (Type III)			
Over/ under voltage protection	Yes			
Grid protection	Yes			
DC injection monitoring	Yes			
Back feed current monitoring	Yes			
Residual current detection	Yes			
Active anti-islanding method	Frequency Shift			
Overload protection	Yes			
Overheat protection	Yes			

- EPS (Off-grid) output

Model	X1-Fit-3.7-W X1-Fit-3.7-M	X1-Fit-5.0-W X1-Fit-5.0K-W X1-Fit-5.0-M	X1-Fit-6.0-W X1-Fit-6.0-M	X1-Fit-7.5-W X1-Fit-7.5-M
Rated EPS apparent power [VA]	3680	5000	6000	7500
Nominal EPS voltage [a.c. V]	230			
Frequency	50/60			
Rated EPS current [a.c. A]	16	21.7	26.1	32.6
EPS peak power [VA]	6000, 10s	7500, 10s	9000, 10s	11250, 10s
Switching time [ms]	internal switch < 10, external switch < 100			
Total harmonic distortion (THDv)	< 2 %			

- Generic data

Model	X1-Fit-3.7-W X1-Fit-3.7-M	X1-Fit-5.0-W X1-Fit-5.0K-W X1-Fit-5.0-M	X1-Fit-6.0-W X1-Fit-6.0-M	X1-Fit-7.5-W X1-Fit-7.5-M
Dimensions (W/H/D) [mm]	482*417*181			
Packing size (W/H/D) [mm]	590*530*315			
Net weight [kg]	23	23	23	23
Gross weight [kg]	27	27	27	28
Heat dissipation treatment	Natural cooling			Smart cooling
Noise emission (typical) [dB]	< 30			< 45
Storage temperature range [°C ]	-40 to +65			
Operating ambient temperature range [°C ]	-35 to +60 (derating at 45)			
Humidity [%]	0% to 100% (no condensation)			
Altitude [m]	< 3000			
Ingress protection	IP65			
Protective class	I			
Night consumption	< 3W			
Overvoltage category	III(MAINS), III(PV, Battery)			
Pollution degree	III			
Installation mode	Wall mounted			
Inverter topology	Non-isolated			
Communication interface	Meter/CT, external control RS485, Pocket series, DRM, USB, CAN			

# Contact Information



## UNITED KINGDOM

---



Unit C-D Riversdale House, Riversdale  
Road, Atherstone, CV9 1FA



+44 (0) 2476 586 998



service.uk@solaxpower.com



## AUSTRALIA

---



21 Nicholas Dr, Dandenong South VIC 3175



+61 1300 476 529



service@solaxpower.com



## TURKEY

---



Fevzi Çakmak mah. aslım cd. no 88 A  
Karatay / Konya / Türkiye



+90 530 252 02 19



service.tr@solaxpower.com



## GERMANY

---



Am Tullnaupark 8, 90402 Nürnberg,  
Germany



+49 (0) 6142 4091 664



service.eu@solaxpower.com



service.dach@solaxpower.com



## USA

---



3780 Kilroy Airport Way, Suite 200, Long  
Beach, CA, US 90806



+1 (408) 690 9464



info@solaxpower.com



## NETHERLANDS

---



Twekkeler-Es 15 7547 ST Enschede



+31 (0) 8527 37932



service.eu@solaxpower.com



service.bnl@solaxpower.com



## POLAND

---



WARSAW AL. JANA P. II 27. POST



+48 662 430 292



service.pl@solaxpower.com



## SPAIN

---



+34 9373 79607



tecnico@solaxpower.com



## ITALY

---



+39 011 19800998



support@solaxpower.it



## BRAZIL

---



+55 (34) 9667 0319



info@solaxpower.com



## PAKISTAN

---



service.pk@solaxpower.com



## SOUTH AFRICA

---



service.za@solaxpower.com

# Warranty Registration Form



## For Customer (Compulsory)

Name \_\_\_\_\_ Country \_\_\_\_\_  
Phone Number \_\_\_\_\_ Email \_\_\_\_\_  
Address \_\_\_\_\_  
State \_\_\_\_\_ Zip Code \_\_\_\_\_  
Product Serial Number \_\_\_\_\_  
Date of Commissioning \_\_\_\_\_  
Installation Company Name \_\_\_\_\_  
Installer Name \_\_\_\_\_ Electrician License No. \_\_\_\_\_

## For Installer

### Module ( If Any )

Module Brand \_\_\_\_\_  
Module Size(W) \_\_\_\_\_  
Number of String \_\_\_\_\_ Number of Panel Per String \_\_\_\_\_

### Battery ( If Any )

Battery Type \_\_\_\_\_  
Brand \_\_\_\_\_  
Number of Battery Attached \_\_\_\_\_  
Date of Delivery \_\_\_\_\_ Signature \_\_\_\_\_

Please visit our warranty website: <https://www.solaxcloud.com/#/warranty> or use your mobile phone to scan the QR code to complete the online warranty registration.



For more detailed warranty terms, please visit SolaX official website: [www.solaxpower.com](http://www.solaxpower.com) to check it.





## **SolaX Power Network Technology (Zhejiang) Co., Ltd.**

Add.: No. 288, Shizhu Road, Tonglu Economic Development Zone,  
Tonglu City, Zhejiang Province, 310000 P. R. CHINA

Tel.: +86 (0) 571 5626 0011

E-mail: [info@solaxpower.com](mailto:info@solaxpower.com)

Copyright © SolaX Power Network Technology (Zhejiang) Co., Ltd. All rights reserved.



320102097301